

**EN OWNER'S MANUAL /**

Instructions for Assembly '10.5 Ft WoodBridge Plus'  
Size 10.5Ft x 13Ft / 3.2 m x 3.9 m (Approx.)  
Ver: 1.0

**FR MANUEL D'INSTRUCTION/**

Instructions pour l'Assemblage '10.5 Pieds WoodBridge Plus'  
Dimension 10.5Pieds x 13Pieds / 3.2 Mètre x 3.9 Mètre (Approx.)  
Ver: 1.0

**DE Benutzerhandbuch /**

Montageanleitung '10.5 Ft WoodBridge Plus'  
Größe: 10.5Ft x 13Ft / 3.2 m x 3.9 m (Ca.)  
Ver: 1.0

**ES MANUAL DEL PROPIETARIO /**

Instrucciones de montaje '10.5 Pies WoodBridge Plus'  
Tamaño 10.5Pies x 13Pies / 3.2 Metros x 3.9 Metros (Aprox.)  
Ver: 1.0

**PT MANUAL DO PROPRIETARIO/**

Instruções de montagem '10.5 pés WoodBridge Plus'  
Tamanho 10.5pés x 13pés / 3.2 Metro x 3.9 Metro (Aprox.)  
Ver: 1.0

**NL Gebruiksaanwijzing voor eigenaar/**

Instructies voor bouw '10.5Voet WoodBridge Plus'  
Maat 10.5voet x 13voet / 3.2 Meter x 3.9 Meter (Ongeveer)  
Versie: 1.0

**CS Příručka uživatele /**

Návod k montáži '10.5 Stopy WoodBridge Plus'  
Velikost 10.5 Stopy x 13 Stopy / 3.2 Metr x 3.9 Metr (Přibližně)  
Verze : 1.0

**SK NÁVOD PRE UŽÍVATEĽA /**

Návod na zloženie '10.5 Stopa WoodBridge Plus'  
Velkost 10.5 Stopa x 13 Stopa / 3.2 m x 3.9 m (približne)  
Pozri: 1.0

**SL PRIROČNIK ZA LASTNIKA /**

Navodila za montažo '10.5 Čevljev WoodBridge Plus'  
Velikost 10.5 Čevljev x 13 Čevljev / 3.2 Metrov x 3.9 Metrov (Približno)  
Razl: 1.0

**HR Gazdinski Priručnik /**

Instrukcije za skupštine '10.5 Stopalo WoodBridge Plus'  
Veličina 10.5 Stopalo x 13 Stopalo / 3.2 Metar x 3.9 Metar (Približno)  
Ver: 1.0

**HU FELHASZNÁLÓI KÉZIKÖNYV /**

Utmutató az összeszereléshez '10.5 Láb WoodBridge Plus'  
10.5Láb x 13Láb / 3.2 Méter x 3.9 Méter (Hozzávetőlegesen)  
Verzió: 1.0

**SV ÄGARENS MANUAL/**

Monteringsinstruktioner för '10.5 Fot WoodBridge Plus'  
Storlek 10.5 fot x 13 fot / 3.2 m x 3.9 m (Ungefär)  
Version: 1.0

**IT MANUALE DEL PROPRIETARIO /**

Istruzioni per l'assemblaggio '10.5 Piedi Woodside-V2'  
Dimensione 10.5 Piedi x 13 Piedi / 3.2Metri x 3.9Metri (Circa)  
Versione 1.0

**PL PODRĘCZNIK UŻYTKOWNIKA /**

Instrukcja montażu '10.5 Stopy WoodBridge Plus'  
Wymiary 10.5Stopy x 13Stopy / 3.2 Metr x 3.9 Metr (W przybliżeniu)  
Wersja: 1.0

**RO MANUAL DE UTILIZARE /**

Instrucțiuni de asamblare '10.5 Picioare WoodBridge Plus'  
Mărimē 10.5Picioare x 13Picioare / 3.2 Metri x 3.9 Metri (Aprox.)  
Ver: 1.0

**BG РЪКОВОДСТВО ЗА ПРИТЕЖАТЕЛЯ /**

Инструкции за сглобяване '10.5 Фута WoodBridge Plus'  
Размер 10.5 Фута x 13 Фута / 3.2 Метра x 3.9 Метра (приблизително)  
Версия: 1.0

**TR KULLANIM KILAVUZU /**

Montaj Talimatları '10.5 Fit WoodBridge Plus'  
10.5Fit x 13Fit / 3.2 m x 3.9m (Yaklaşık olarak)  
Sürüm: 1.0

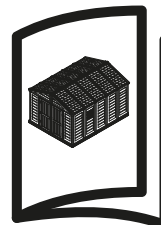
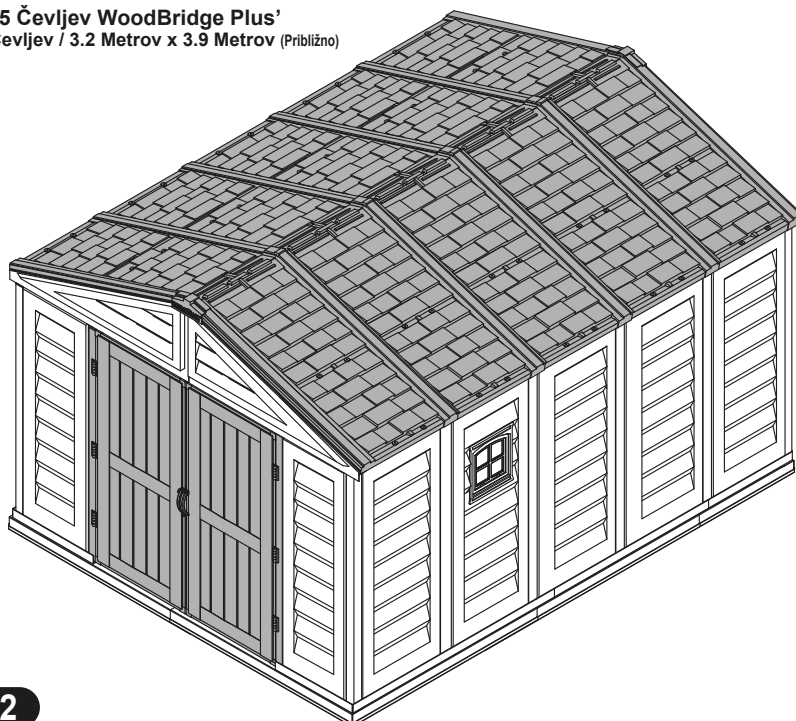
**Model # 40234-2**

EN

**Building Dimensions :**

Approximate Size	Storage		Exterior Dimension				Interior Dimension		Door Opening		
	Area	Volume	Base Dimension		Roof Edge to Edge		Wall to Wall				
			inch	cm	inch	cm	inch	cm	inch	cm	
10.5 Ft x 13 Ft	132.3 Sq. Ft	805.1 Cu.Ft	<b>Width</b>	125 1/2	318.7	127 7/8	324.8	123 3/8	313.3	60 5/8	154
3.2 m x 3.9 m	12.3 Sq.m	22.8 Cu.m	<b>Depth</b>	156 1/2	397.7	159 1/2	405	154 3/8	392.3		
			<b>Height</b>			91 7/8	233.2	73	185.5	71 1/2	181.5

Snow load tested max. 16lbs / sq.foot (As per IP Standard).

"We recommend to clear snow from the Roof top after each Snowfall."

A snow depth of more than 10cm can become hazardous!

FR

**Dimensions du bâtiment :**

Taille approximative	Stockage		Dimension extérieure				Dimension intérieure		Ouverture de porte		
	Secteur	Volume	Dimension de base		Toit de bord au bord		Mur à mur				
			pouce	cm	pouce	cm	pouce	cm	pouce	cm	
10.5 Pieds x 13 Pieds	132.3 Carré pieds	805.1 Pieds cube	<b>Largeur</b>	125 1/2	318.7	127 7/8	324.8	123 3/8	313.3	60 5/8	154
3.2 Mètre x 3.9 Mètre	12.3 Mètre carré	22.8 Mètre cube	<b>Profondeur</b>	156 1/2	397.7	159 1/2	405	154 3/8	392.3		
			<b>Hauteur</b>			91 7/8	233.2	73	185.5	71 1/2	181.5

Charge de neige testé max. 16lbs / Carré pieds(conformément à la norme IP)

"Nous recommandons d'enlever la neige du Toit après chaque Enneigement."

Une épaisseur de neige de plus de 10cm peut devenir dangereux!

DE

**Gebäude Abmessung:**

Ungefähre Größe	Speicher		Außen Abmessung				Innen Abmessung		Türöffnung		
	Bereich	Volumen	Fundament Abmessung		Dach Kante bis Kante		(von Wand zu Wand)				
			inch	cm	inch	cm	inch	cm	inch	cm	
10.5 Ft x 13 Ft	132.3 Sq. Ft	805.1 Cu.Ft	<b>Breite</b>	125 1/2	318.7	127 7/8	324.8	123 3/8	313.3	60 5/8	154
3.2 m x 3.9 m	12.3 Sq.m	22.8 Cu.m	<b>Tiefe</b>	156 1/2	397.7	159 1/2	405	154 3/8	392.3		
			<b>Höhe</b>			91 7/8	233.2	73	185.5	71 1/2	181.5

Schneelast max. getestet. 16lbs /sq.Foot (gem. Standard IP).

"Wir empfehlen, nach jedem Schneefall den Schnee vom Dach zu räumen."

Eine Schneetiefe von mehr als 10cm kann gefährlich werden!

ES

**Medidas de la caseta:**

El Tamaño a aproximado	Área de almacenaje		Dimensión exterior				Dimensión interior		Abertura de la puerta		
	Área	Volumen	Dimensión de la base		Borde de la azotea al borde		pared a pared				
			Pulgada	cm	Pulgada	cm	Pulgada	cm	Pulgada	cm	
10.5 Pies x 13Pies	132.3 Pies cuadrados	805.1 Pies Cúbicos	<b>Anchura</b>	125 1/2	318.7	127 7/8	324.8	123 3/8	313.3	60 5/8	154
3.2 Metros x 3.9 Metros	12.3 Metros cuadrados	22.8 Metros Cúbicos	<b>Profundidad</b>	156 1/2	397.7	159 1/2	405	154 3/8	392.3		
			<b>Altura</b>			91 7/8	233.2	73	185.5	71 1/2	181.5

Carga de nieve probado max. 16lbs / Pies cuadrados (según el estándar de IP).

"Se recomienda limpiar la nieve de la azotea después de cada nevada."

Una profundidad de nieve de más de 10cm puede llegar a ser peligrosa!

PT

**Área de Construção:**

Dimensão aproximada	Área de Arrumação		Dimensão Exterior				Dimensão Interior		Abertura da Porta		
	Área	Volume	Dimensão da base		Amplitude do Telhado		(Parede a Parede)				
			Polegada	centímetro	Polegada	centímetro	Polegada	centímetro	Polegada	centímetro	
10.5 pés x 13 pés	132.3 Pies quadrado	805.1 Pies cúbico	<b>Comprimento</b>	125 1/2	318.7	127 7/8	324.8	123 3/8	313.3	60 5/8	154
3.2 Metro x 3.9 Metro	12.3 Metro quadrado	22.8 Metro cúbico	<b>Profundidade</b>	156 1/2	397.7	159 1/2	405	154 3/8	392.3		
			<b>Altura</b>			91 7/8	233.2	73	185.5	71 1/2	181.5

Carga de neve testado max. 16lbs / Pies quadrado (conforme padrão IP).

"Recomendamos limpar a neve do topo do telhado após cada queda de neve."

Uma profundidade de neve de mais de 10cm pode tornar-se perigosa!

NL

## Gebouw afmeting:

Benadering Maat	Opslag		Buitenkant afmeting				Binnenkant afmeting		Deur opening		
	Gebied	Volume	Basis afmeting		Dakrand tot rand		Muur tot muur				
10.5 Voet x 13 Voet	132.3 Vierkante voet	805.1 Kubieke voet	inch cm		inch cm		inch cm		inch cm		
3.2 m x 3.9 m	12.3 Vierkante meter	22.8 Kubieke meter	Wijde	125 1/2	318.7	127 7/8	324.8	123 3/8	313.3	60 5/8	154
			Diepte	156 1/2	397.7	159 1/2	405	154 3/8	392.3		
			Hoogte			91 7/8	233.2	73	185.5	71 1/2	181.5

Sneeuw belasting getest max. 16lbs / Vierkante voet (volgens het standaard IP-).

“We raden aan sneeuw uit het dak te verwijderen na elke sneeuwval.”

Een sneeuwdiepte van meer dan 10 cm kan gevaarlijk worden!

CS

## Budova rozměr

Přibližné rozměry	Skladování		Vnější rozměr				Vnitřní rozměr		Otevírání dveří		
	Plocha	Objem	Základní rozměr		Na okraj střechy edge		zdi ke zdi				
10.5 Stopy x 13 Stopy	132.3 Čtvereční Stopy	805.1 Krychlový Stopy	inch cm		inch cm		inch cm		inch cm		
3.2 Metr x 3.9 Metr	12.3 Čtvereční metr	22.8 Krychlový Metr	Šířka	125 1/2	318.7	127 7/8	324.8	123 3/8	313.3	60 5/8	154
			Hĺoubka	156 1/2	397.7	159 1/2	405	154 3/8	392.3		
			Výška			91 7/8	233.2	73	185.5	71 1/2	181.5

Zkouška zatížení sněhu max. 16lbs / Čtvereční Stopy (podle normy IP).

“Doporučujeme odstranit sníh ze střešního krytu po každém sněžení.”

Možná hloubka sněhu větší než 10 cm může být nebezpečná!

SK

## Stavebné rozmer

Približné veľkosti	Sklad		Vonkajší rozmer				Interiér rozmer		Otvorenie dverí		
	Priestor	Objem	Base rozmer		Strešné okraja k okraju		Zdi k múru				
10.5 Stopa x 13 Stopa	132.3 Stopa štvorcový	805.1 Stopa kubický	inch cm		inch cm		inch cm		inch cm		
3.2 m x 3.9 m	12.3 Meter štvorcový	22.8 Meter kubický	Šírka	125 1/2	318.7	127 7/8	324.8	123 3/8	313.3	60 5/8	154
			Hĺbka	156 1/2	397.7	159 1/2	405	154 3/8	392.3		
			Výška			91 7/8	233.2	73	185.5	71 1/2	181.5

Testovanie zaťaženia snehu max. 16lbs / Stopa štvorcový (podľa IP štandardu).

“Odporúčame odstrániť sneh zo strechy po každej snehu.”

Z hĺbky snehu väčšej ako 10 cm sa môže stať nebezpečné!

SL

## Zidanje obseg

približno velikost	Skladiščenje		zunanji obseg				notranji obseg		vrata predrtina		
	Območje	Prostornina	osnova obseg		streha rob v rob		obdati obzidati				
10.5 Čevljev x 13 Čevljev	132.3 Kvadratnih Čevljev	805.1 Kubičnih Čevljev	cola cm		cola cm		cola cm		cola cm		
3.2 Metrov x 3.9 Metrov	12.3 Kvadratnih Metrov	22.8 Kubičnih Metrov	širina	125 1/2	318.7	127 7/8	324.8	123 3/8	313.3	60 5/8	154
			globina	156 1/2	397.7	159 1/2	405	154 3/8	392.3		
			višina			91 7/8	233.2	73	185.5	71 1/2	181.5

Snow obremenitev testiran max. 16lbs / Kvadratnih Čevljev (po standardu IP).

“Priporočamo, da počistite sneg z vrha strehe po vsakem sneženju.”

Z globino snega več kot 10 cm lahko postane nevarno!

HR

## Zgrada dimenzija

Približno određena mjera	Skladištenje		Vanjski dimenzija				Interijer dimenzija		Vrata Open		
	Područje	Svezak	Temeljiti dimenzija		Krov rub to rub		Zidni to zidni				
			inch	cm	inch	cm	inch	cm	inch	cm	
10.5 Stopalo x 13 Stopalo	132.3 Četvornih Stopalo	805.1 Kubni Stopalo	širina	125 1/2	318.7	127 7/8	324.8	123 3/8	313.3	60 5/8	154
3.2 Metar x 3.9 Metar	12.3 Četvornih Metar	22.8 Kubni Metar	dubina	156 1/2	397.7	159 1/2	405	154 3/8	392.3		
			visina			91 7/8	233.2	73	185.5	71 1/2	181.5

Testirano opterećenje max. 16lbs / Četvornih Stopalo (prema IP standardu).  
 “Preporučujemo čišćenje snijega s vrha krova nakon svakog snijega.”  
 Nema dubine snijega veće od 10 cm može biti opasna!

HU

## Építési dimenzió

Hozzávetőleges mérete	Tárolás		Külső méret				A belső dimenzió		Ajtónyitás		
	Terület	Mennyiség	Alap dimenzió		Tető élétől él		A fal és a fal				
			Hüvelyk	cm	Hüvelyk	cm	Hüvelyk	cm	Hüvelyk	cm	
10.5 Láb x 13 Láb	132.3 Négyzet Láb	805.1 Köb Láb	Szélesség	125 1/2	318.7	127 7/8	324.8	123 3/8	313.3	60 5/8	154
3.2 Méter x 3.9 Méter	12.3 Négyzet méter	22.8 Köbméter	Oldalmagasság	156 1/2	397.7	159 1/2	405	154 3/8	392.3		
			Magasság			91 7/8	233.2	73	185.5	71 1/2	181.5

A terhelés max. 16lbs / Négyzet Láb (IP-szabvány szerint).  
 “Javasoljuk, hogy minden hóesést követően tisztítsa meg a havat a tetőtől.”  
 A 10 cm-nél hosszabb hóvastagság veszélyessé válhat!

SV

## Byggnadsdimensioner:

Ungefärlig storlek	Lager		Yttre dimensioner				Inre dimensioner		Dörröppning		
	Area	Volym	Basdimensioner		Tak kant till kant		Vägg till vägg				
			Tum	cm	Tum	cm	Tum	cm	Tum	cm	
10.5 fot x 13 fot	132.3 kvadrat fot	805.1 kubik fot	Bredd	125 1/2	318.7	127 7/8	324.8	123 3/8	313.3	60 5/8	154
3.2 m x 3.9 m	12.3 kvadratmeter	22.8 kubik meter	Djup	156 1/2	397.7	159 1/2	405	154 3/8	392.3		
			Höjd			91 7/8	233.2	73	185.5	71 1/2	181.5

Snow last testas max. 16lbs / kvadrat fot (enligt IP-standard).  
 “Vi rekommenderar att klara snö från taket efter varje snöfall.”  
 Ett snödjup på mer än 10 cm kan bli farligt!

IT

## Dimensioni di Costruzione:

Dimensione approssimativa	Deposito		Dimensione Esterna				Dimensioni Interne		Apertura della Porta		
	Area	Volume	Dimensione della Base		Soffitto da Lato a Lato		Da Muro a Muro				
			Inches	Centimetri	Inches	Centimetri	Inches	Centimetri	Inches	Centimetri	
10.5 Piedi x 13 Piedi	132.3 Piedi Quadrati	805.1 Piedi Cubici	Ampiezza	125 1/2	318.7	127 7/8	324.8	123 3/8	313.3	60 5/8	154
3.2 Metri x 3.9 Metri	12.3 Metri Quadrati	22.8 Metri Cubici	Profondità	156 1/2	397.7	159 1/2	405	154 3/8	392.3		
			Altezza			91 7/8	233.2	73	185.5	71 1/2	181.5

Snow carico testato max. 16lbs / Piedi Quadrati (come per IP standard).  
 “We consigliamo di eliminare la neve dalla tetto del tetto dopo ogni nevicata.”  
 Una profondità di neve di oltre 10 cm può diventare pericolosa!



PL

## Wymiary budowlane:

Przybliżone wymiary	Magazynowa		Wymiary zewnętrzne				Wymiary wewnętrzne		Otwieranie drzwi		
	Powierzchnia	Kubatura	Wymiary fundamentów		Dachu od krawędzi do krawędzi		od ściany do ściany				
			inch	cm	inch	cm	inch	cm	inch	cm	
10.5 Stopy x 13 Stopy	132.3 Stopy kwadratowy	805.1 Stopy sześcienny	<b>Szerokość</b>	125 1/2	318.7	127 7/8	324.8	123 3/8	313.3	60 5/8	154
3.2 Metr x 3.9 Metr	12.3 Metr kwadratowy	22.8 Metr sześcienny	<b>Głębokość</b>	156 1/2	397.7	159 1/2	405	154 3/8	392.3		
			<b>Wysokość</b>			91 7/8	233.2	73	185.5	71 1/2	181.5

Obciążenia śniegiem testowałem max. 16lbs / Stopy kwadratowy(jak na IP Standard).

“Zalecamy wyczyszczenie śniegu z dachu dachu po każdym śniegu.”

Możliwość śniegu powyżej 10 cm może stać się niebezpieczna!

RO

## Cladirea dimensiuni

Dimensiunea aproximativa	Depozitarea		Dimensiunea exterioara				Dimensiunea interne		deschiderea usii		
	Suprafata	Volumul	Baza dimensiuni		Acoperisul marginea la marginea		perete in perete				
			inch	cm	inch	cm	inch	cm	inch	cm	
10.5 Picioare x 13 Picioare	132.3 Picioare pătrați	805.1 Picioare cubi	<b>Latimea</b>	125 1/2	318.7	127 7/8	324.8	123 3/8	313.3	60 5/8	154
3.2 Metri x 3.9 Metri	12.3 Metri pătrați	22.8 Metri cubi	<b>Adancimea</b>	156 1/2	397.7	159 1/2	405	154 3/8	392.3		
			<b>Inaltimea</b>			91 7/8	233.2	73	185.5	71 1/2	181.5

Rezultatea de încărcare maximă testată. 16lbs / Picioare pătrați (conform standardului IP).

“Vă recomandăm să eliminați zăpada din partea superioară a acoperișului după fiecare zăpadă.”

O adâncime de zăpadă mai mare de 10 cm poate deveni periculoasă!

BG

## Сградата измерение

Ориентировачна размер	Съхранение		Външно измерение				Министърът на вътрешните измерение		Вратата отваряне		
	Площ	Обем	База измерение		Покрив край до край		Стената на стената				
			Инча	Сантиметра	Инча	Сантиметра	Инча	Сантиметра	Инча	Сантиметра	
10.5 Фута x 13 Фута	132.3 Квадратни Фута	805.1 Кубични Фута	<b>Ширина</b>	125 1/2	318.7	127 7/8	324.8	123 3/8	313.3	60 5/8	154
3.2 Метра x 3.9 Метра	12.3 Квадратни Метра	22.8 Кубични Метра	<b>Дълбочина</b>	156 1/2	397.7	159 1/2	405	154 3/8	392.3		
			<b>Височина</b>			91 7/8	233.2	73	185.5	71 1/2	181.5

Тестване на тежестта на снемане макс. 16lbs / Квадратни Фута (според IP Стандарт).

“След всеки снеговалеж препоръчваме да изчистите снега от покрива на покрива.”

Дълбочина на снега повече от 10 см може да стане опасна!

TR

## İnşaat boyutu

Tahmini büyüklüğü	Depo		Dış boyutlar				İç boyutu		Kapı açılması		
	Alan	Hacim	Temel boyutundaki		sertliği için harekete		Duvardan duvara				
			İnç	Sanтимetre	İnç	Sanтимetre	İnç	Sanтимetre	İnç	Sanтимetre	
10.5 Fit x 13 Fit	132.3 Metre Fit	805.1 Kübik Fit	<b>Genişlik</b>	125 1/2	318.7	127 7/8	324.8	123 3/8	313.3	60 5/8	154
3.2 m x 3.9 m	12.3 Metrekare	22.8 Kübik metre	<b>Derinlik</b>	156 1/2	397.7	159 1/2	405	154 3/8	392.3		
			<b>Yükseklik</b>			91 7/8	233.2	73	185.5	71 1/2	181.5

Saat yükü test max. 16lbs / Metre Fit (IP Standardına göre).

“Her Kar yağışı sonrasında Çatı üstten kar temizlemenizi öneririz.”

Kar derinliği 10 cm'den fazla tehlikeli olabilir!

**EN Tools You Will Need**

- |                                  |                             |
|----------------------------------|-----------------------------|
| 1. Cordless Drill - Philips Head | 6. Tape Measure             |
| 2. Screwdriver - Philips Head    | 7. Hand Gloves              |
| 3. Carpenters Square             | 8. Eye Protector            |
| 4. 8' Step Ladder                | 9. Waterproof Clear Silicon |
| 5. Level - 3ft.                  | 10. Hammer or Rubber mallet |

**FR Outils dont vous aurez besoin**

- |                                     |                                   |
|-------------------------------------|-----------------------------------|
| 1. Perceuse sans fil – Tête Philips | 6. Ruban à mesurer                |
| 2. Tournevis - Tête Philips         | 7. Gants                          |
| 3. Équerre du Menuisier             | 8. Protecteur des Yeux            |
| 4. Escabeau 8'                      | 9. Silicone neutre étanche        |
| 5. Niveau - 3ft.                    | 10. Marteau ou maillet caoutchouc |

**DE Benötigte Werkzeuge**

- |   |                                 |
|---|---------------------------------|
| 1. Akku-Bohrschrauber - Kreuzschlitzbit | 6. Maßband                      |
| 2. Kreuzschlitz-Schraubenzieher         | 7. Handschuhe                   |
| 3. Winkelmaß                            | 8. Schutzbrille                 |
| 4. 8' Leiter                            | 9. Wasserdichtes klares Silikon |
| 5. Wasserwaage – 1 m                    | 10. Hammer oder Gummihammer     |

**ES Herramientas necesarias para el montaje**

- |  |  |
|--|--|
| 1. Atornillador eléctrico con cabeza estrella- | 6. Cinta métrica                         |
| 2. Destornillador estrella / Philips           | 7. Use guantes de seguridad              |
| 3. Gafas protectoras                           | 8. Escuadra                              |
| 4. Escalera de 8 peldaños                      | 9. Silicio transparente a prueba de agua |
| 5. Nivel de 1m                                 | 10. Martillo o mazo de goma              |

**PT Ferramentas que irá precisar**

- |                                    |                                      |
|------------------------------------|--------------------------------------|
| 1. Cordless Berbequim              | 6. Fita Métrica                      |
| 2. Chave de fenda – cabeça estrela | 7. Luvas                             |
| 3. Esquadro de carpinteiro         | 8. Protector Ocular                  |
| 4. Escadote 8'                     | 9. Silicone Transparente Impermeável |
| 5. 3ft. Nível                      | 10. martelo ou malho de borracha     |

**NL Gereedschappen die u nodig zult hebben**

- |   |                              |
|---|------------------------------|
| 1. Snoerloze boormachine met gekruiste kop      | 6. Meetlint                  |
| 2. Snoerloze schroevendraaier met gekruiste kop | 7. Handschoenen              |
| 3. Winkelhaak                                   | 8. Oogbescherming            |
| 4. Ladder met acht treden                       | 9. Waterdicht Clear Silicone |
| 5. Waterpas                                     | 10. Hamer of rubberen hamer  |

**CS Budete potřebovat toto nářadí**

- |                                 |                            |
|---------------------------------|----------------------------|
| 1. Bezdrátová vrtačka - Philips | 6. Svinovací metr          |
| 2. Vrták - Philips              | 7. Rukavice                |
| 3. Tesafské náměstí             | 8. Ochranné brýle          |
| 4. 8mí stupňový žebřík          | 9. Vodotěsný čistý silikon |
| 5. Vodováha - 3ft.              | 10. Kladivo nebo kaučuk    |

**SK Nástroje, ktoré budete potrebovať**

- |                                      |                                  |
|--------------------------------------|----------------------------------|
| 1. Bezdrôtová vrtačku - Philips Head | 6. Meter                         |
| 2. Šraubovák – Philips Head          | 7. Rukavice                      |
| 3. Stolársky meter                   | 8. Ochrana na oči                |
| 4. 8' Rebrík                         | 9. Vodotesný čistý silikon       |
| 5. Zdvihák – 3 stopy.                | 10. Kladivo alebo gumená palička |

**SL Orodje, ki ga boste potrebovali**

- |                                   |                                   |
|-----------------------------------|-----------------------------------|
| 1. Brežična vrtalna- glava Philip | 6. Merilni trak                   |
| 2. Vijačnik-glava Philip          | 7. Rokavice                       |
| 3. Mizarski kvadrat               | 8. zaščitna očala                 |
| 4. 2438,4 mm dvokraka lestev      | 9. Vodoodporni Clear Silikon      |
| 5. Nivelirka - 0,91 m             | 10. Kladivo za kladivo ali kavčuk |

**HR Alati, Trebat će Vam**

- |                                      |                                  |
|--------------------------------------|----------------------------------|
| 1. Bežični Svrdlo – Philips Voditelj | 6. Traka Divizor                 |
| 2. Vijak Vozač - Philips Voditelj    | 7. Ručni Rukavice                |
| 3. Drvodjelac Četverkut              | 8. Oko Zaštitnik                 |
| 4. 8' Korak Ljestve                  | 9. Vodonepropusni bistri silikon |
| 5. Razina – 3 stoplo.                | 10. Čekić ili gumeni čekić       |

**HU A szükséges szerszámok**

- |                                       |                             |
|---------------------------------------|-----------------------------|
| 1. Vezeték nélküli fúró – csillagfejű | 6. Mérőszalag               |
| 2. Csavarhúzó – csillagfejű           | 7. Kesztyűk                 |
| 3. Ácsderékszög                       | 8. Szemvédő                 |
| 4. 8-fokú létra                       | 9. Vízálló, tiszta szilikon |
| 5. Vízszintmérő.                      | 10. Hammer vagy gumi sisak  |

**SV Verktyg du kommer att behöva**

- |                                      |                               |
|--------------------------------------|-------------------------------|
| 1. Sladdlös bormaskin - Philips borr | 6. Måttband                   |
| 2. Skruvmejsel - krysshuvud          | 7. Verktygshandskar           |
| 3. Vinkelhake                        | 8. Ögonskydd                  |
| 4. 8-fots stege                      | 9. Vattentät Klar Silikon     |
| 5. vattenmått - 3fot.                | 10. Hammer eller Gummihammare |

**IT Gli Attrezzi di cui Avrai Bisogno**

- |  |                                      |
|--|--------------------------------------|
| 1. Trapano senza fili – Punta a stella | 6. Metro a Nastro                    |
| 2. Cacciavite – Punta a stella         | 7. Guanti                            |
| 3. Squadra metallica                   | 8. Protezione per gli occhi          |
| 4. Scala ad 8 pioli                    | 9. Silicone trasparente impermeabile |
| 5. Livello – 3 piedi                   | 10. Martello o martello di gomma     |

**PL Potrzebne narzędzia**

- |   |                                      |
|---|--------------------------------------|
| 1. Bezprzewodowa wkrętarka – krzyżakowa | 6. Taśma miernicza                   |
| 2. Śrubokręt krzyżakowy                 | 7. Rękawice ochronne                 |
| 3. Kałownik stolarski                   | 8. Okulary ochronne                  |
| 4. 8' Drabina składana                  | 9. Wodoodporny przezroczysty silikon |
| 5. Poziomica – 91,4 cm                  | 10. Młotek lub młotek gumowy         |

**RO Instrumentele de care aveți nevoie**

- |                                     |                                    |
|-------------------------------------|------------------------------------|
| 1. Șurubelniță – cap Philips        | 6. Ruletă de măsurat               |
| 2. Mașină de găurit – cap Philips   | 7. Mănuși de protecție             |
| 3. Echer de dulgherie               | 8. Protecție pentru ochi           |
| 4. Scară cu trepte de 8' (20.32 cm) | 9. Silicon transparent impermeabil |
| 5. Nivel - 3ft.                     | 10. Ciocan sau ciocan din cauciuc  |

**BG Инструменти, които ще ви трябват**

- |   |                              |
|---|------------------------------|
| 1. Безжична бормашина - с глава Philips | 6. Рулетка                   |
| 2. Отвертка – с глава Philips           | 7. Ръкавици                  |
| 3. Прав ъгъл                            | 8. Маска за очите            |
| 4. Стълба – 20 см (8')                  | 9. Водоустойчив ясен силикон |
| 5. Нивелир – 1 м (3ft).                 | 10. Чук или гумен чук        |

**TR İhtiyaç duyacağınız aletler**

- |                                    |                               |
|------------------------------------|-------------------------------|
| 1. Kablosuz Matkap- Philips Başlık | 6. Mezura                     |
| 2. Tornavida-Philips Başlık        | 7. Eldiven                    |
| 3. Marangoz gönyesi                | 8. Göz Koruyucu               |
| 4. 8 Basamaklı Merdiven            | 9. Su geçirmez Şeffaf Silikon |
| 5. Seviye- 91,5 cm.                | 10. Çekiç veya Kauçuk tokmak  |

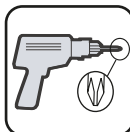

1

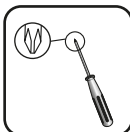

2



3



4

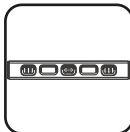

5



6



7



8

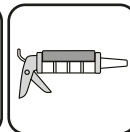

9

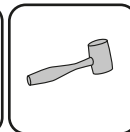

10

<b>EN</b> Parts List	<b>CS</b> Seznam součástí	<b>IT</b> Lista delle varie parti
<b>FR</b> Liste des pièces	<b>SK</b> Zoznam častí	<b>PL</b> Lista części
<b>DE</b> Teileliste	<b>SL</b> Seznam delov	<b>RO</b> Lista elementelor componente
<b>ES</b> La Lista de Partes	<b>HR</b> Dijelovi Lists	<b>BG</b> Списък на частите
<b>PT</b> Lista de Peças	<b>HU</b> Alkatrésztlista	<b>TR</b> Parça Listesi
<b>NL</b> Onderdelenlijst	<b>SV</b> Komponentlista	

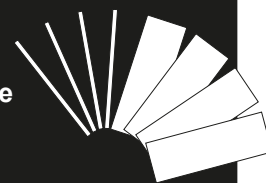

- EN** 1.Check all parts prior to installation.  
2.Before starting installation, please refer to Safety & Precautions.

- FR** 1.Vérifier toutes les pièces avant l'installation.  
2.Avant de commencer l'installation, référez-vous svp à Sécurité et Précautions.

- DE** 1.Prüfen Sie alle Teile vor der Montage.  
2.Lesen Sie vor dem Aufbau die Sicherheitsanweisungen.

- ES** 1.Verifique todo el despiece antes del montaje.  
2.Antes de comenzar el montaje, consulte el apartado de seguridad y precauciones.

- PT** 1.Confirme todas as peças antes da instalação.  
2.Antes de iniciar a instalação, cheque item "Segurança e Cuidados".

- NL** 1.Controleer vooraf of alle onderdelen aanwezig zijn.  
2.Voordat u begint met installeren, verwijzing naar veiligheid voorschriften.

- CS** 1.Něž začnete s montáží, zkontrolujte všechny součásti.  
2.Před montáží si prosím přečtete Bezpečnost a bezpečnostní opatření.

- SK** 1.Skontrolujte všetky časti pred inštaláciou.  
2.Skôr ako začnete s inštaláciou, prečítajte si Bezpečnosť a bezpečnostné opatrenia.

- SL** 1.Pred montažo preverite vse dele.  
2.Pred začetkom namestitve, glejte VARNOST & VARNOSTNI UKREPI.

- HR** 1.Provjera svih dijelova prije instalacije.  
2.Prije nego Vi počete instalacija, molim vas pogledajte Sigurnost i mjere opreza

- HU** 1.Ellenőrizzen minden alkatrészt az összeszerelés megkezdése előtt.  
2.Az összeszerelés megkezdése előtt kérjük vegye figyelembe a biztonsági utasításokat.

- SV** 1.Kolla alla delar före installationen.  
2.innan man startar installationen ska man läsa igenom säkerhet & försiktighetsåtgärder.

- IT** 1.Controlla tutte le parti prima dell'installazione.  
2.Prima di incominciare con l'istallazione, per favore leggi attentamente I punti illustrati nel paragrafo Sicurezza ed Installazione.

- PL** 1.Sprawdź wszystkie części zanim przystąpisz do montażu.  
2.Przed rozpoczęciem instalacji należy przeczytać rozdział Bezpieczeństwo i środki ostrożności.

- RO** 1.Verificați toate părțile componente înainte de instalare.  
2.Înainte de a începe asamblarea, consultați capitolul. Măsuri de siguranță și protecție.

- BG** 1.Проверете всички части преди монтажа.  
2.Преди започване на монтажа, моля разгледайте Безопасност и Защита.

- TR** 1.Kurulumdan önce tüm parçaları kontrol ediniz.  
2.Montaja başlamadan önce lütfen Güvenlik ve Önlemler kısmına bakınız.



	VBA01	1		VRA50	2		FDCL	1
	VBA04	3		VRA51	1		FDCR	1
	VBA05	3		VRA14	2	FCC	4	
	VBA06	1		VRA15	2	FMC	11	
	VBA07	1		VRA53	8	FCB	4	
	VBA08	1		VRA54	10	RJ	4	
	VCA01	2		CLA1	1	CBC	5	
	VCA03	6		CLA2	4	LH ↑	3	
	VCA04	2		CLA3	11	RH ↑	3	
	VRA01	2		CLA4	1	L	1	
	VRA02	2		WPA1↑	15	R	1	
	VRA06	4		WPA2↑	1	EC	2	
	VRA07	2		RPA1	1	EPS	2	
VRA04	4	RPA2		3	VFA15	4		
VRA52	4		RPA3	1	VRA19	2		
VJA01	11		RPA4	1	VRA20	8		
VRA05	1		RPA5	3	PPG	106		
VRA42	2		RPA6	1	PPGL	4		
VRA43	2		FPA1	1	PIN	106		
VRA44	2		FPA2	1	PINL	4		
VRA45	2		FPA3	1	BP	4		
VRA46	2		FPA4	1	S1	345		
VRA47	2		DL	1	S2	34		
VRA48	2		DR	1	S7	186		
VRA49	1				SBC1	28		
					PW	28		
					F1	26		



<b>EN</b> Foundation	<b>CS</b> Základy	<b>IT</b> Fondamenta
<b>FR</b> Fondation	<b>SK</b> Základ	<b>PL</b> Podstawa
<b>DE</b> Fundament	<b>SL</b> Temelj	<b>RO</b> Fundația
<b>ES</b> La cimentación	<b>HR</b> Temelj	<b>BG</b> Фундамент
<b>PT</b> Fundação	<b>HU</b> Alap	<b>TR</b> Temel
<b>NL</b> Fundering	<b>SV</b> Grunden	

	VFA01	2
	VFA02	2
	VFA11	2
	VFA12	2
	VFA07	1
	VFA08	1

	VFA13	4
	VFA14	4
	VFA06	5
	VFA09	4
	VFA10	12

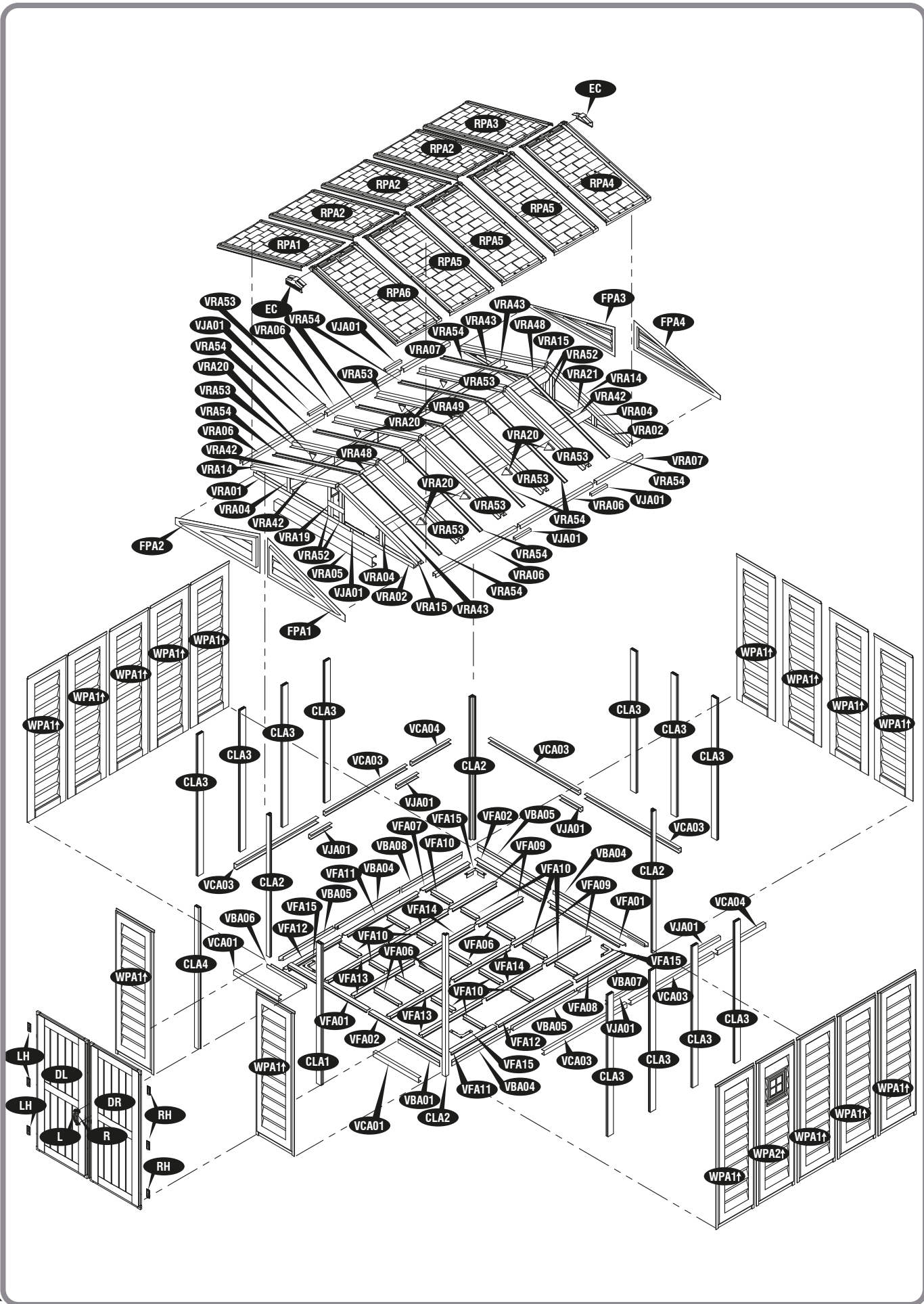



- 1** → # 10-17
- 2** → # 18
- 3** → # 19-31
- 4** → # 32-48
- 5** → # 49-58
- 6** → # 59-65
- 7** → # 66-68

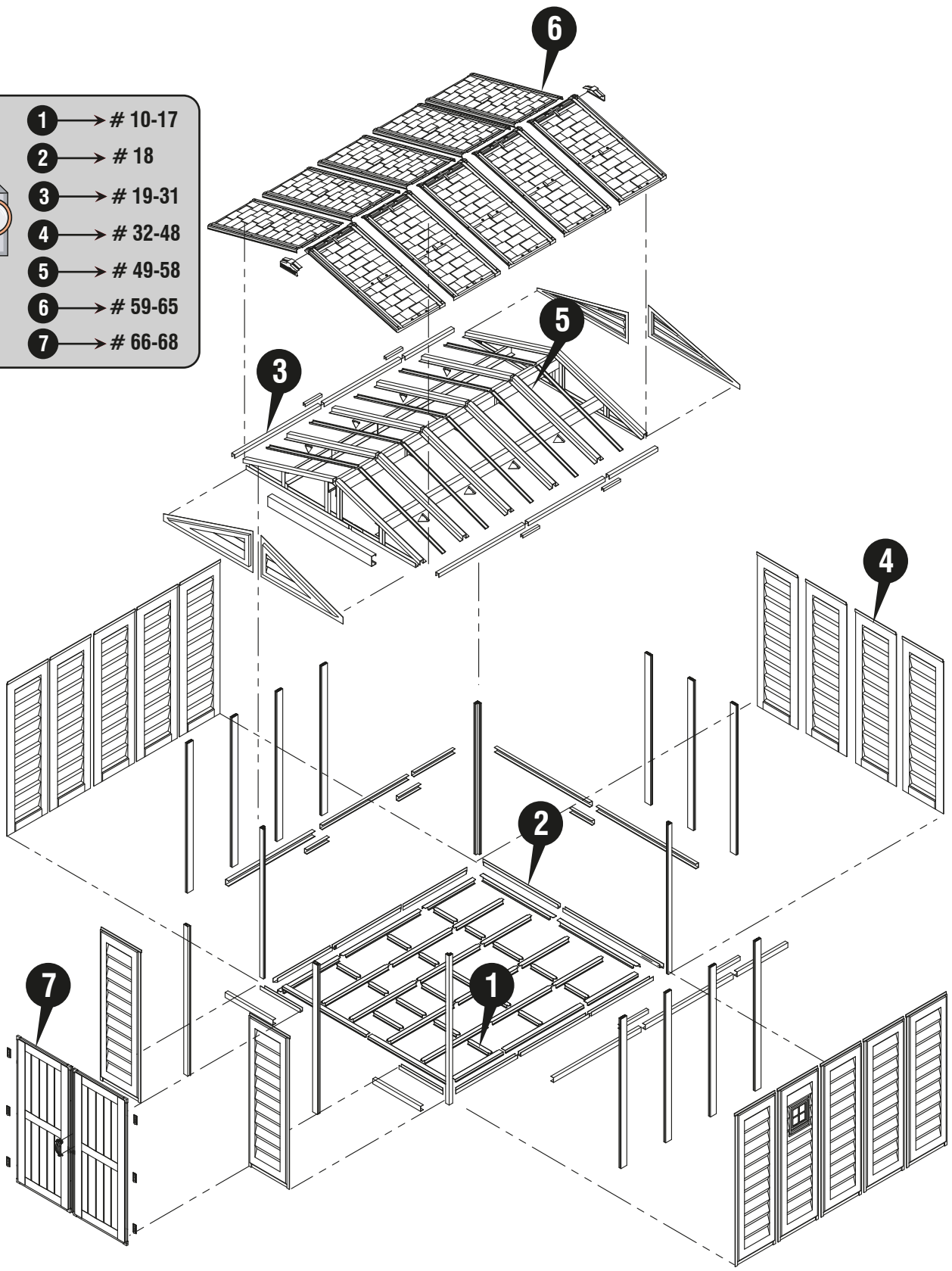



1	EN Foundation	CS Základy	IT Fondamenta
	FR Fondation	SK Základ	PL Podstawa
	DE Fundament	SL Temelj	RO Fundația
	ES La cimentación	HR Temelj	BG Фундамент
	PT Fundação	HU Alap	TR Temel
	NL Fundering	SV Grunden	

- EN** 1. Set the Torque limit of your Screw drill to #3 or #4 to ensure the Screws do not strip the Metal reinforcements.  
2. It is important that these instructions are followed step by step.  
3. Don't install under windy conditions.  
4. All parts are clearly marked and care should be taken to use the correct one.  
5. If you are building the shed against a wall, build it 2.5 ft. away then slide it in. (Only for Duramax foundation & Wooden foundation)

- FR** 1. Réglez la limite de couple de votre perceuse Vis à n # 3 ou n # 4 pour s'assurer que les vis ne supprime pas les renforts métalliques  
2. Il est important que ces instructions soient suivies pas à pas.  
3. Ne pas installer sous conditions de vent.  
4. Toutes les pièces sont clairement identifiées et il convient de veiller à utiliser la bonne.  
5. Si vous construisez le hangar contre un mur, le construire à un écart de 2,5 pi, puis le glisser. (ceci n'est applicable pour la Fondation Duramax Fondation en bois).

- DE** 1. Stellen Sie das Drehmoment Ihres Akkuschaubers auf Stufe 3 oder 4. Dies verhindert ein Überdrehen der Schrauben.  
2. Diese Anleitung muss unbedingt Schritt für Schritt befolgt werden.  
3. Die Montage nicht bei windigem Wetter vornehmen.  
4. Alle Teile sind deutlich gekennzeichnet und es ist darauf zu achten, dass die richtige verwendet wird.  
5. Wenn Sie den Schuppen an einer Wand bauen, bauen sie es 2,5 Fuß weg, dann schieben Sie es ein.  
(Nur für Duramax Fundament & Holzfundament)

- ES** 1. Establecer el límite de par de su taladro tornillo de 3 y 4 para que no traspasa los refuerzos metálicos  
2. Es importante que estas instrucciones se sigan paso a paso.  
3. No instale en días de mucho viento.  
4. Recuerde que todas las piezas están marcadas para su correcto montaje.  
5. Si usted está construyendo la caseta contra una pared, móntela a una distancia 2.5 pies (75cm) y una vez montada deslícela hacia la pared. (esto sólo es aplicable para la estructura de kit de suelo Duramax).

- PT** 1. Defina o limite de Torque de sua broca parafuso para # 3 ou # 4 para garantir que os parafusos não tira os reforços de metal.  
2. É importante que estas instruções sejam seguidas passo a passo.  
3. Não instale sob condições com forças ventanosas.  
4. Todas as peças estão claramente marcadas e deve-se tomar cuidado para usar a correta.  
5. Se você está construindo o galpão contra uma parede, construa-o a 2,5 pés de distância para então encostá-lo na mesma. (Apenas para o Duramax fundação e base de madeira)

- NL** 1. Stel de Torque limiet van uw Schroef boormachine op # 3 en # 4 om de schroeven zorgen niet strip de Metal versterkingen.  
2. Het is belangrijk dat volgende instructies stap voor stap worden gerespecteerd.  
3. Nooit de schuur installeren onder winderige omstandigheden.  
4. Alle onderdelen zijn duidelijk gemarkeerd en er moet op worden gelet dat de juiste wordt gebruikt.  
5. Als u het schuur tegen muur aan het bouwen bent, bouw u maar de schuur op 70cm afstand en schuif die er tegen de muur aan. (Alleen voor Duramax foundation & Houten foundation)

- CS** 1. Nastavte mezní hodnotu točivého momentu vrtacího vrtáku na #3 nebo #4, abyste zajistili, že šrouby neztáhnou kovové výztuhy.  
2. Je důležité aby jste tento návod sledovali krok za krokem.  
3. Nemontujte při větrném počasí.  
4. Všechny díly jsou jasně označeny a je třeba dbát na správnou funkci.  
5. Pokud stavíte přístřešek proti zdi, postavte jí 70cm stranou a poté jí přisuňte. (Pouze pro Duramax založení a dřevěné základy)

- SK** 1. Nastavte limit krútiaceho momentu vrtacieho vrtáka na #3 alebo #4, aby ste zaistili, že skrutky nezaberajú kovové výztuhy.  
2. Je nutné dodržiavať tieto inštrukcie krok za krokom.  
3. Neinštalujte za veterných podmienok.  
4. Všetky časti sú zreteľne označené a treba dbať na to, aby boli použité správne.  
5. Ak budujete múru, postavte ju 2,5 stôp. pred, a potom ju zasunúť. (Len pre Duramax založenie a drevené základy)



- SL** 1.Za omejitev vrtilnega momenta vijáčnega vijaka nastavite #3 ali #4, da zagotovite, da vijaki ne ojačijo kovinskih ojačitev.  
2.Pomembno je, da sledite opisanim navodilom korak za korakom.  
3.Montaže ne izvijajte, kadar piha močen veter.  
4.Vsi deli so jasno označeni in pazite na pravilno uporabo.  
5.Če se gradi skladišče proti steni, ga graditi 2,5 ft. stran, nato pa ga potisnite v. (samo za Duramax temelj in leseno osnovo)

- HR** 1.Postavite granico zakretnog momenta Vašeg vijčanog bušilica na #3 ili #4 kako biste osigurali da vijci ne skidaju metalna pojačanja.  
2.To je važno da ovih instrukcije su slijedili korak po korak.  
3.Nemojte instalirati pod vjetrovitim uvjetima.  
4.Svi dijelovi su jasno označeni i treba voditi brigu o ispravnom korištenju.  
5.Ako gradite proliveno zid, izgradite ga 2,5 m. daleko, a zatim ga gurnite. (Samo za Duramax zaklade i drveni temelja)

- HU** 1.Állítsa a csavarhúzó nyomatékhatárait #3 vagy #4-re, hogy a csavarok ne csavarják le a fém vasalatokat  
2.Fontos, hogy az itt következő instrukciókat lépésről lépésre betartsa.  
3.Szeles időben ne végezzen összeszerelést.  
4.Minden alkatrész egyértelműen megjelölve, és gondoskodni kell a helyes használatáról.  
5.Ha egy fészket építesz a falhoz, építsd meg 2,5 métert. távolítsa el, majd csúsztassa be. (Csak a Duramax Alapítvány és a Fa Alapítvány)

- SV** 1.Ställ in momentskruvren på din skruvborr till #3 eller #4 för att säkerställa att skruvarna inte slår av metallförstärkningarna.  
2.Det är viktigt att dessa instruktioner följs steg för steg.  
3.Installera inte när det är blåsigt.  
4.Alla delar är tydligt märkta och försiktighet bör vidtas för att använda rätt.  
5.Om du bygger ett skjul mot en vägg, bygg det 2,5 ft. bort och skjut in den. (Endast för Duramax Foundation & Wooden stiftelse)

- IT** 1. Impostare il limite di coppia della fresa a vite a #3 o #4 per assicurare che le viti non striscia i rinforzi metallici  
2.E' molto importante che queste istruzioni vengano seguite passo dopo passo.  
3.Non installare in presenza di forte vento.  
4.Tutte le parti sono chiaramente contrassegnate e occorre prestare attenzione per utilizzare quella corretta.  
5.Se si sta costruendo il capannone contro un muro, costruirlo 2,5 ft. via, poi farlo scorrere in. (Solo per Duramax Foundation e Fondazione di legno)

- PL** 1.Zestaw limit momentu obrotowego twój śruby wiercenia do # 3 lub # 4, aby upewnić się, że śruby nie taśmy wzmocnień  
2.Bardzo ważne jest, by dokładnie stosować się do niniejszej instrukcji.  
3.Nie należy montować w przypadku silnego wiatru.  
4.Wszystkie części są wyraźnie oznaczone i należy zachować ostrożność, aby użyć właściwego.  
5.Jeśli budujesz szopę przy ścianie, buduj ją 2,5 stopy dalej, a następnie wsuń ją. (Tylko do fundamentu Duramax i drewnianego fundamentu).

- RO** 1.Setați limita de cuplu a burghiului dvs. de șurub la #3 sau #4 pentru a vă asigura că șuruburile nu lărgesc armăturile metalice.  
2.Este importantă respectarea pas cu pas a acestor instrucțiuni.  
3.Nu instalați dacă vântul atinge viteze mari.  
4.Toate părțile sunt marcate în mod clar și trebuie să se țină seama de utilizarea celei corecte.  
5.Dacă construiți vaporășul pe perete, construiți-l la o distanță de 2,5 ft, apoi glisați-l. (Doar pentru fundația Duramax & fundație din lemn)

- BG** 1.Нагласете границата на въртящия момент на винтовата витла до #3 или #4, за да се уверите, че винтовете не изрязват металните подсилвания.  
2.Важно е да следвате инструкциите стъпка по стъпка.  
3.Да не се монтира при ветровито време.  
4.Всички части са ясно маркирани и трябва да се внимава да се използва правилната.  
5.Ако сте изградане на навес срещу стена, изградане то на 2,5 фута далеч след това го плъзнете инча (Само за Duramax фондация & дървени основи)

- TR** 1.Vidaların Metal takviyeleri soymadığından emin olmak için Vidalı matkabınızın Moment sınırını #3 veya #4'e ayarlayın.  
2.Talimatların sırasıyla uygulanması önemlidir.  
3.Rüzgarlı havalarda kurmayınız.  
4.Tüm parçalar açıkça işaretlenmiştir ve doğru olanı kullanmak için özen gösterilmelidir.  
5.Bir duvara kulübe bina varsa, o 2.5 ft kurmak. uzakta bir biçimde kaydırın. (Yalnızca Duramax vakif ve Ahşap vakif için)





- (EN) DuraMax must be installed on a DuraMax Foundation, level wooden platform or a level concrete foundation, that has an outside dimension of 129 3/8" x 160 1/2" (3287mm x 4077mm).
- (FR) DuraMax doit être installé sur une plate-forme en bois de niveau ou une fondation en béton de niveau, qui a une dimension extérieure de 129 3/8" x 160 1/2" (3287mm x 4077mm).
- (DE) Duramax muss auf einer ebenen Holzplattform oder einem ebenen Betonfundament mit einer Außenabmessung von 129 3/8" x 160 1/2" (3287mm x 4077mm) installiert werden.
- (ES) DuraMax debe instalarse en una plataforma de madera nivelada o una base de hormigón nivelada, que tenga una dimensión exterior de 129 3/8" x 160 1/2" (3287mm x 4077mm).
- (PT) Duramax deve ser instalado em uma base Duramax, plataforma de madeira de nível ou uma base de concreto nivelada, que tem uma dimensão externa de 129 3/8" x 160 1/2" (3287mm x 4077mm).
- (NL) Duramax moet geïnstalleerd worden op een Duramax foundation, level houten platform of een betonconcreet, dat heeft een externe dimensie van 129 3/8" x 160 1/2" (3287mm x 4077mm).
- (CS) Duramax musí být instalován na základně Duramax, dřevěnou plošinu nebo rovinnou základovou konstrukci, který má vnější rozměr 129 3/8" x 160 1/2" (3287mm x 4077mm).
- (SK) Firma Duramax musí byť inštalovaná na základni Duramax, na drevenej plošine alebo na úrovni betónu, ktorý má vonkajší rozmer 129 3/8" x 160 1/2" (3287mm x 4077mm).
- (SL) Duramax mora biti nameščen na temelju Duramax, ravne lesene ploščadi ali ravne betonske podlage, ki ima zunanjo dimenzijo 129 3/8" x 160 1/2" (3287mm x 4077mm).
- (HR) Duramax mora biti instaliran na temeljima Duramax, drvenoj platformi ili razini konkretnog betona, koji ima vanjsku dimenziju od 129 3/8" x 160 1/2" (3287mm x 4077mm).
- (HU) A Duramax-ot Duramax alapra, szintetikus fapadlóra vagy szintetikus betonra kell telepíteni, amelynek külső mérete 129 3/8" x 160 1/2" (3287mm x 4077mm).
- (SV) Duramax måste installeras på en Duramax-grund, en plan träplattform eller en jämn betongfundament, som har en yttre dimension av 129 3/8" x 160 1/2" (3287mm x 4077mm).
- (IT) Duramax deve essere installato su una base Duramax, una piattaforma di legno a livello o una base di calcestruzzo a livello, che ha una dimensione esterna di 129 3/8" x 160 1/2" (3287mm x 4077mm).
- (PL) DuraMax musi być zainstalowany na poziomej drewnianej platformie lub poziomym fundamencie betonowym o wymiarze zewn. trzonym 129 3/8" x 160 1/2" (3287mm x 4077mm).
- (RO) Duramax trebuie instalat pe o fundație Duramax, platformă de lemn de nivel sau fundație de beton, care are o dimensiune exterioară de 129 3/8" x 160 1/2" (3287mm x 4077mm).
- (BG) Duramax трябва да се монтира на основата на Duramax, дървена платформа на нивото или на бетонна основа, който има външно измерение 129 3/8" x 160 1/2" (3287mm x 4077mm).
- (TR) Duramax, bir Duramax vakfı, düz ahşap platform veya düz bir beton temel üzerine kurulmalıdır, dış çapı 129 3/8" x 160 1/2" (3287mm x 4077mm).



- EN** Note : For plywood cut size, refer to page 71-72.
- FR** Note : Pour le contreplaqué dimensions, reportez-vous à la page 71-72.
- DE** Anmerkung : für Schnittgrößen aus Sperrholz, siehe Seite 71-72.
- ES** Pozor : Para contrachapado cortado tamaño, consulte la página 71-72.
- PT** Nota: Para o tamanho de contraplacado corte, consulte a página 71-72.
- NL** Opmerking: Zie pagina 71-72 voor het knippen van multiplex.
- CS** Poznámka: Velikost řezu překližky viz str. 71-72.
- SK** Poznámka: Pre veľkosti preglejka rezu, viď strana 71-72.
- SL** Opomba: Za velikost vezanega lesa glejte stran 71-72.
- HR** Napomena: Za veličinu rezanja šperploča pogledajte stranicu 71-72.
- HU** Megjegyzés: A rétegelt lemez méretének méretét lásd az 71-72. oldalon.
- SV** Obs! För plywoodskärning, se sidan 71-72.
- IT** Nota: per le dimensioni di taglio del compensato, fare riferimento a pagina 71-72.
- PL** Uwaga: Informacje na temat rozmiaru sklejkii można znaleźć na stronie 71-72.
- RO** Notă: Pentru dimensiunea tăiată a placajului, consultați pagina 71-72.
- BG** Забелџка: За размера на шперплата, вижте стр. 71-72.
- TR** Not: Kontrplak kesim boyutu için, bkz. Sayfa 71-72.

EN Parts needed

FR Pièces nécessaires

DE Benötigte Teile

ES Piezas necesitadas

PT Peças Necessárias

NL Onderdelen nodig

CS Potřebné součásti

SK Potrebné časti

SL Dele, ki jih boste potrebovali

HR Dijelovi potreban

HU Szükséges részek

SV Delar som behövs

IT Parti occorrenti

PL Niezbędne elementy

RO Elementele componente necesare

BG Необходими части

TR Gerekli parçalar

VFA01	2
VFA02	2
VFA06	5
VFA07	1
VFA08	1
VFA09	4
VFA10	12

VFA11	2
VFA12	2
VFA13	4
VFA14	4
VFA15	4
S1	80

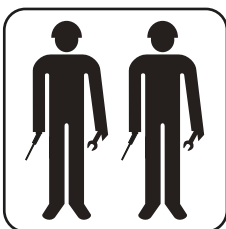

EN Two people needed.

FR Deux personnes nécessaires.

DE Zwei Leute brauchen.

ES Dos personas que se necesitan.

PT Duas pessoas precisavam.

NL Er waren twee mensen nodig.

CS Potřebovali dva lidi.

SK Dvaja ľudia potrebovali.

SL Potrebovali sta dve osebi.

HR Trebale su dvije osobe.

HU Két embernek volt szüksége.

SV Två personer behövde.

IT Sono necessarie due persone.

PL Potrzebne były dwie osoby.

RO Două persoane au avut nevoie.

BG Нужни бяха двама души.

TR İki kişiye ihtiyaç vardı.



1

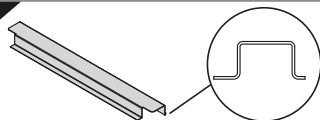

VFA01 (x2)

VFA02 (x2)

S1 (x4)

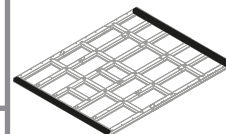

x2

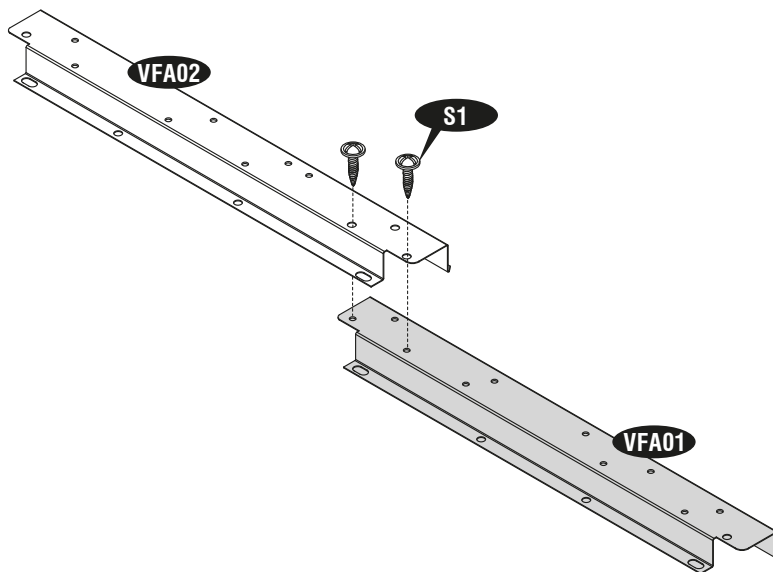



2

VFA11 (x1)  
VFA12 (x1)  
VFA07 (x1)

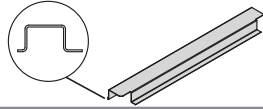

S1 (x3)

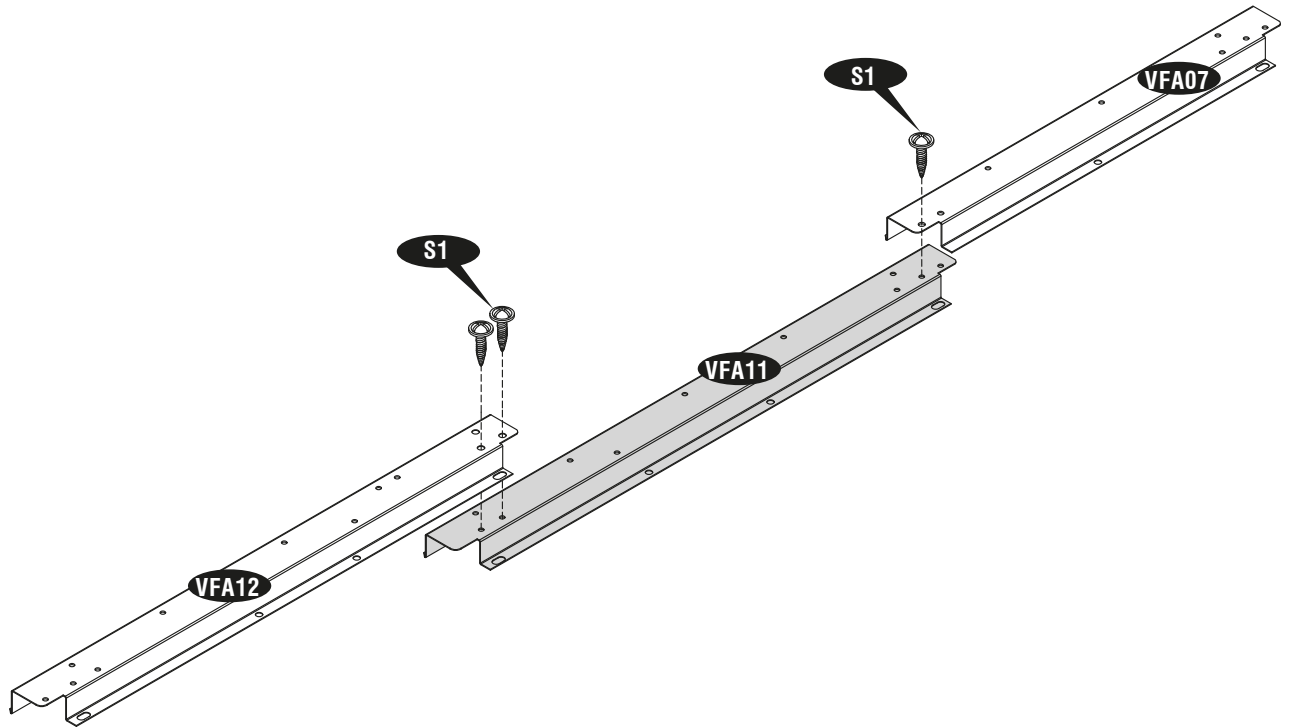
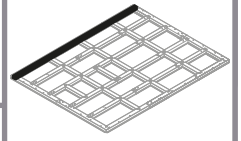

3

VFA11 (x1)  
VFA12 (x1)  
VFA08 (x1)

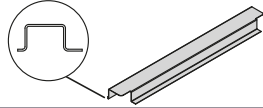

S1 (x3)

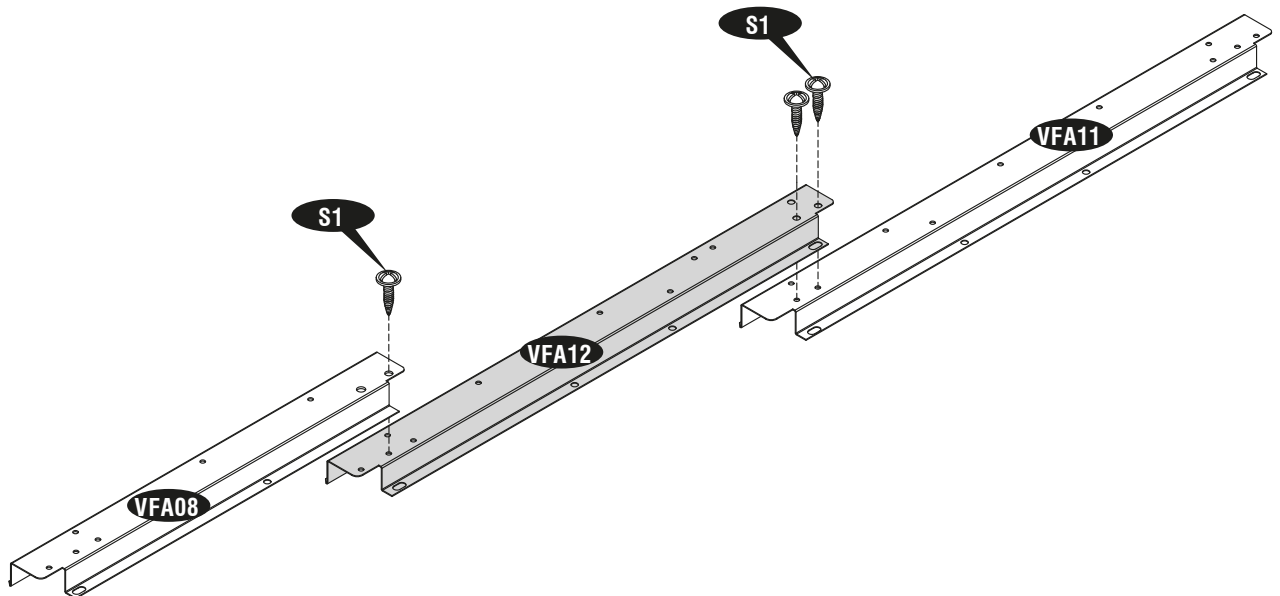
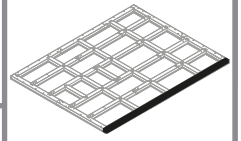

4

VFA13 (x4)  
VFA14 (x4)  
VFA09 (x4)

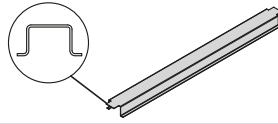

S1 (x16)

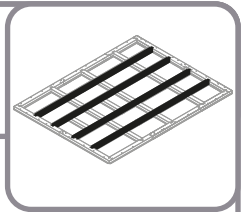

x4

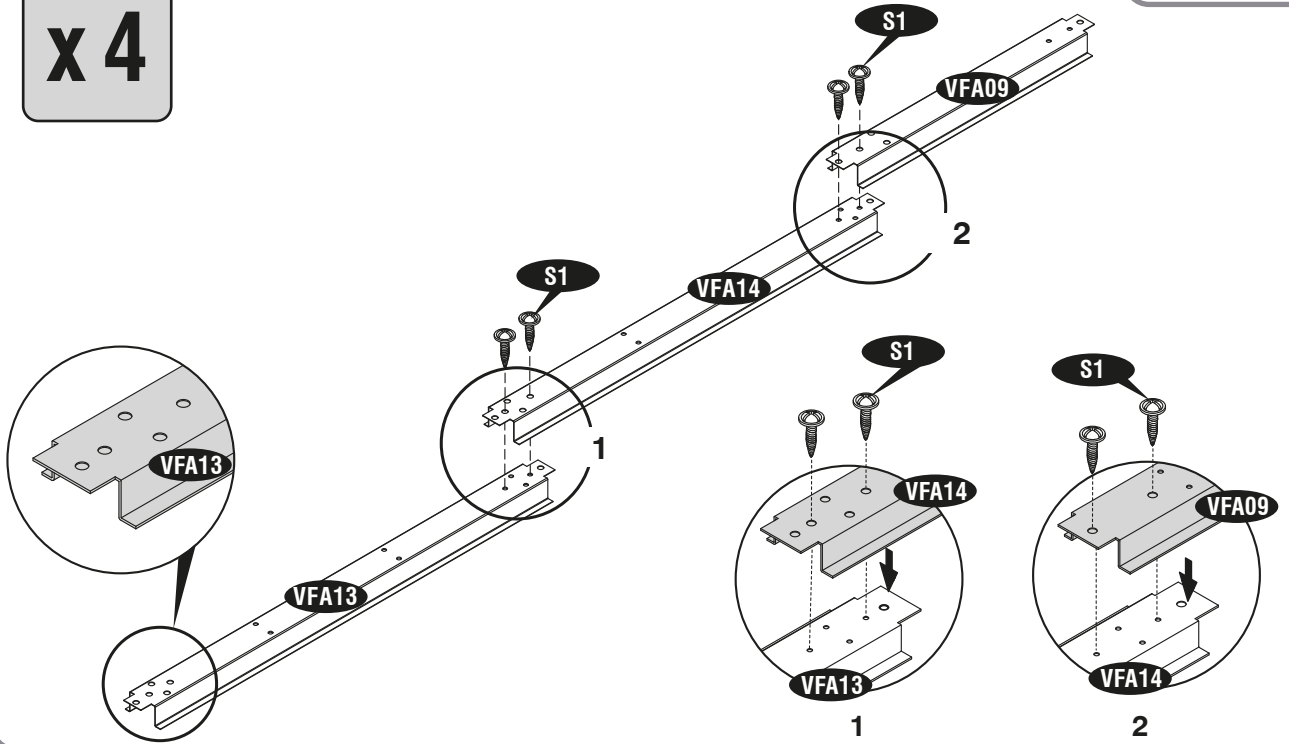

5

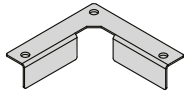

VFA15 (x2)

S1 (x6)

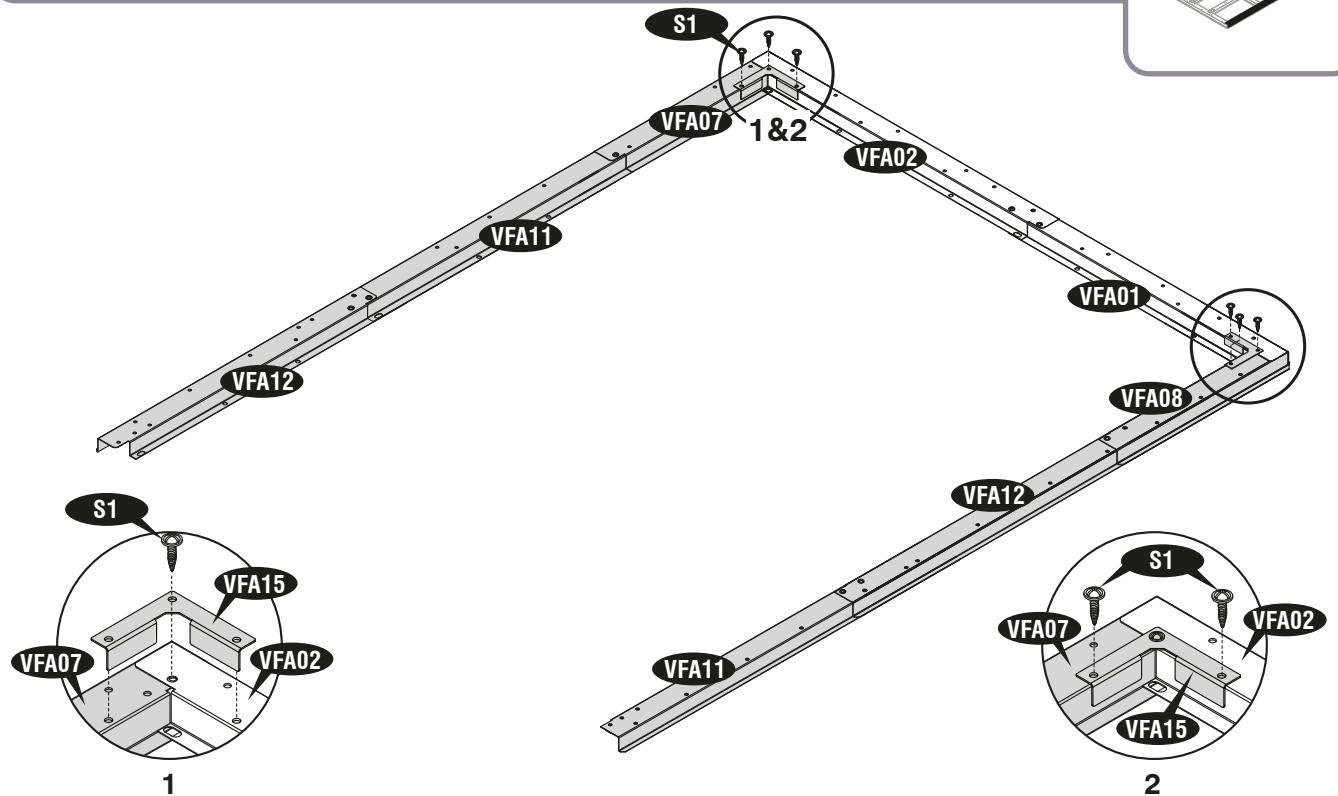
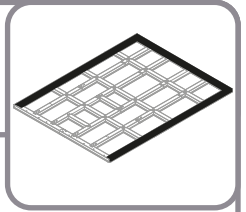

6

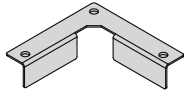

VFA15 (x2)



S1 (x6)

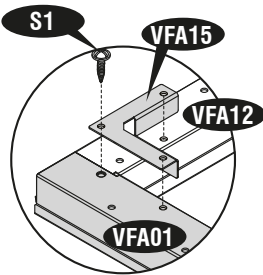
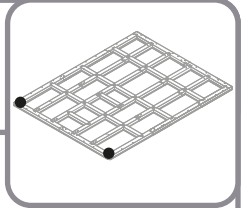

1

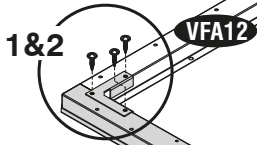

1&2

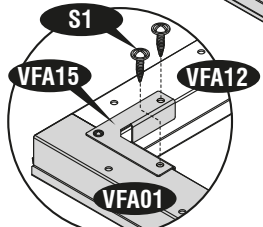

2

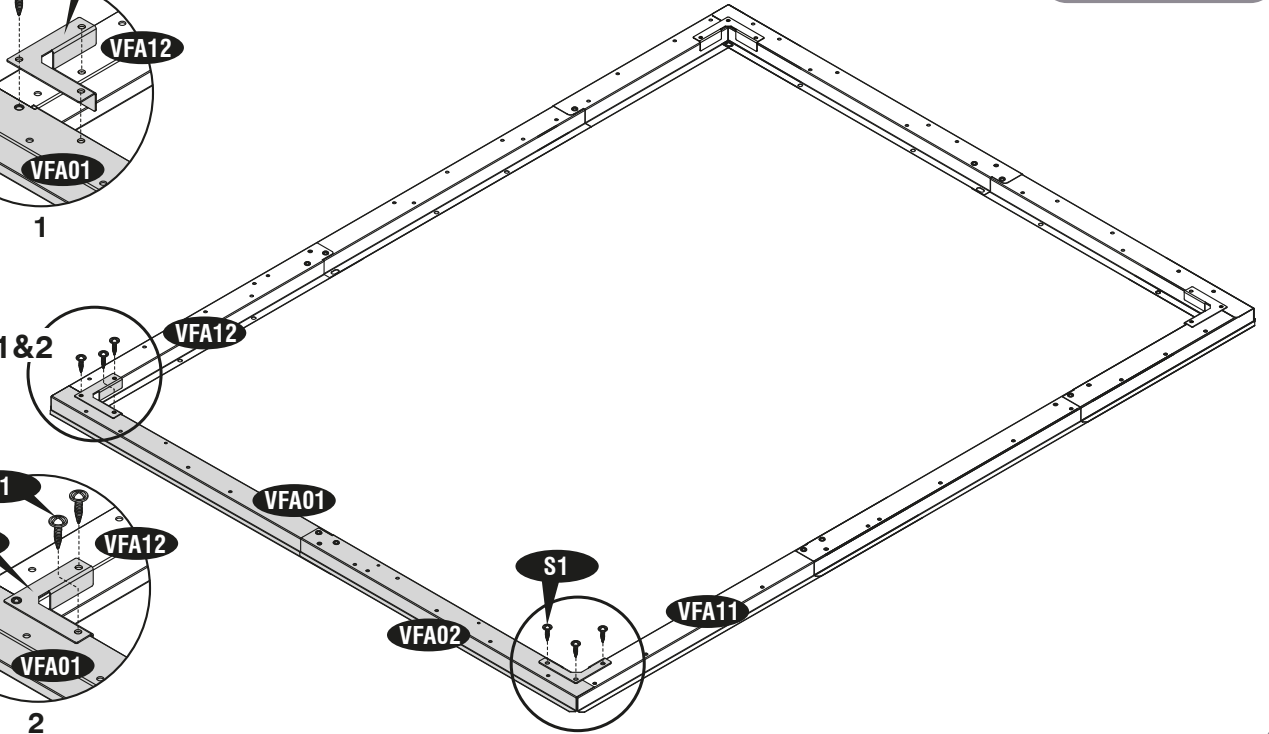

7



S1 (x8)

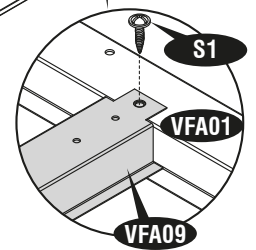
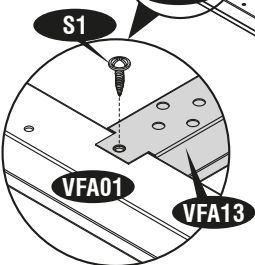
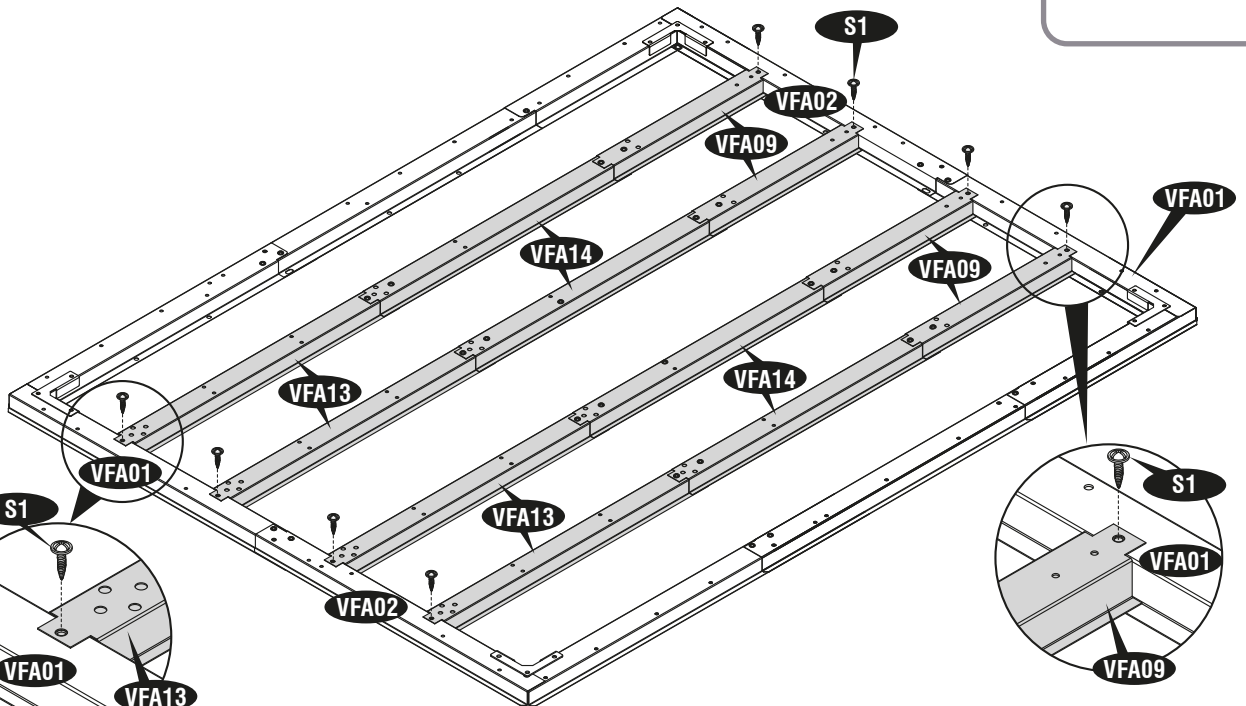
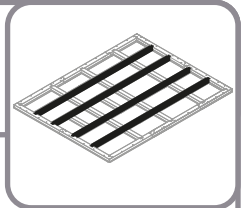

8

VFA06 (x5)

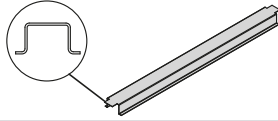

S1 (x10)

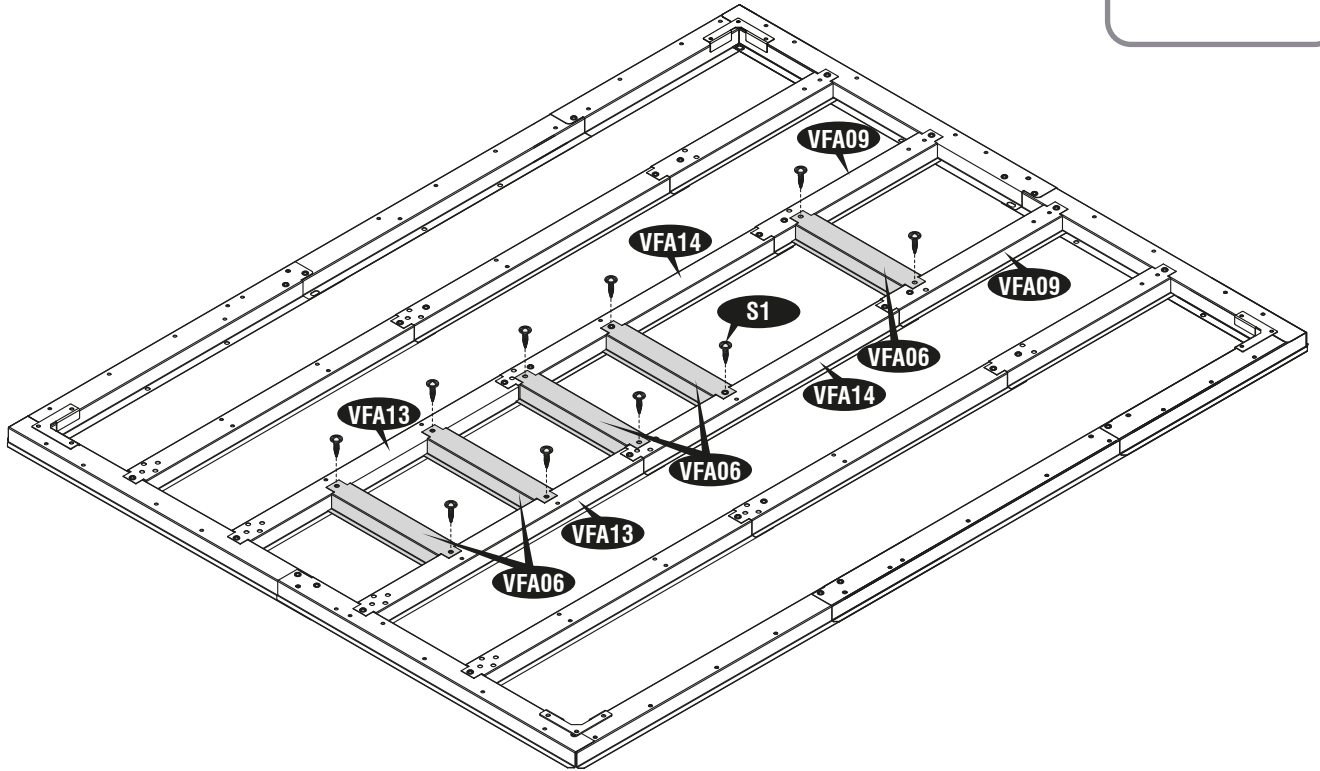
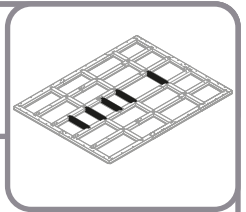

9

VFA10 (x12)

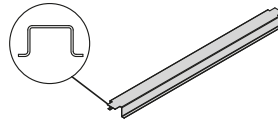

S1 (x24)

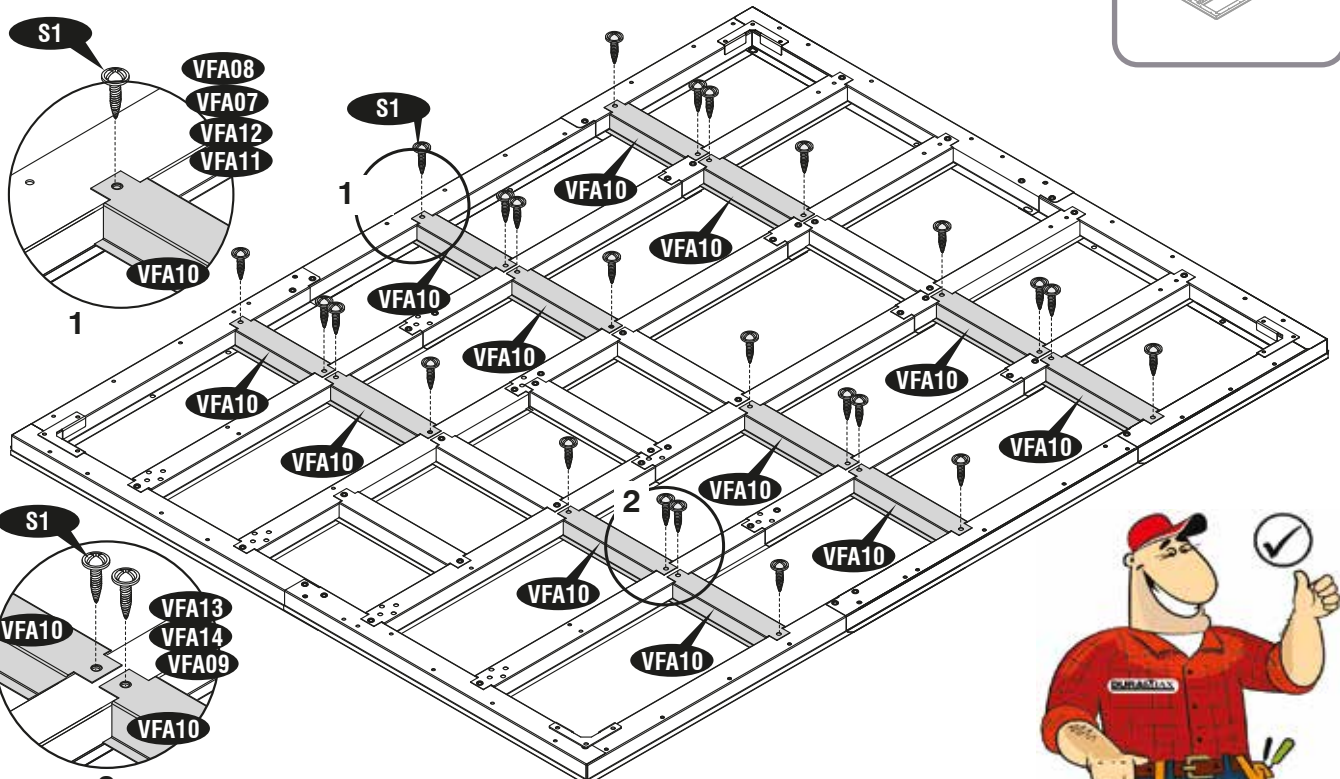
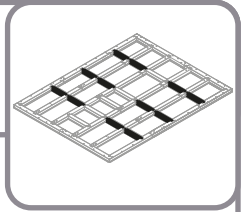



- 2**
- EN Base Frame
  - CS Základní kostra
  - IT Cornice di Base
  - FR Canaux de base
  - SK Základňový rám
  - PL Rama fundamentowa
  - DE Bodenrahmen
  - SL Osnovni okvir
  - RO Rama bazei
  - ES Armazón de la base
  - HR Baza okvir
  - BG Основна Рама
  - PT Base de armação
  - HU Alapváz
  - TR Temel Çerçevesi
  - NL Basis frame
  - SV Basram

- EN Parts needed
- CS Potřebné součásti
- IT Parti occorrenti
- FR Pièces nécessaires
- SK Potřebné časti
- PL Niezbędne elementy
- DE Benötigte Teile
- SL Dele, ki jih boste potrebovali
- RO Elementele componente necesare
- ES Piezas necesitadas
- HR Dijelovi potreban
- BG Необходими части
- PT Peças Necessárias
- HU Szükséges részek
- TR Gerekli parçalar
- NL Onderdelen nodig
- SV Delar som behövs

VBA01	1
VBA04	3
VBA05	3
VBA06	1
VBA07	1
VBA08	1
S1	42



**1**

S1 (x42)

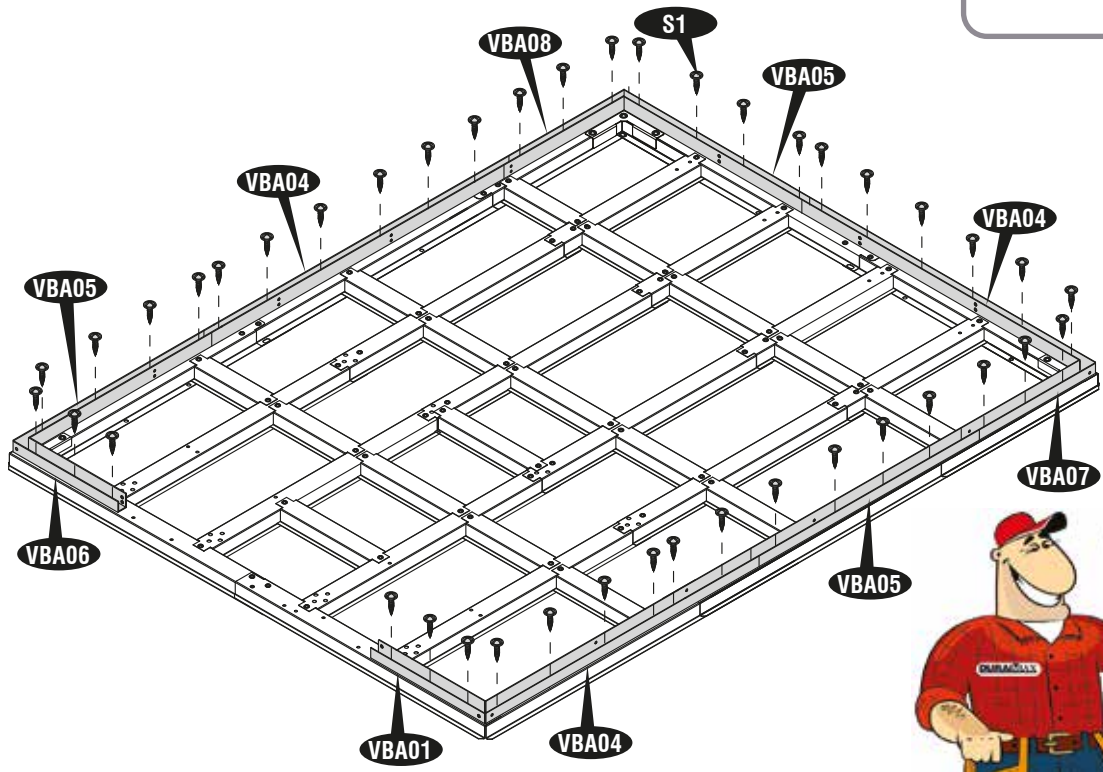





3

- EN Roof Structure Pre-Assembly
- FR Pré-assemblage de la structure du toit
- DE Vormontage der Dachkonstruktion
- ES Premontaje de estructura de techo
- PT Pré-montagem da estrutura do telhado
- NL Dakconstructie Pre-montage
- CS Předmontáž střešní konstrukce
- SK Predmontáž strešnej konštrukcie
- SL Pred montažo strešne konstrukcije
- HR Pred montaža krovne konstrukcije
- HU Tetőszerkezet előszerelése
- SV Takkonstruktion förmontering
- IT Pre-assemblaggio della struttura del tetto
- PL Wstępny montaż konstrukcji dachu
- RO Preasamblare a structurii acoperișului
- BG Предварителен монтаж на покривна конструкция
- TR Çatı Yapısı Ön Montajı

- EN Parts needed
- FR Pièces nécessaires
- DE Benötigte Teile
- ES Piezas necesitadas
- PT Peças Necessárias
- NL Onderdelen nodig
- CS Potřebné součásti
- SK Potrebné časti
- SL Dela, ki jih boste potrebovali
- HR Dijelovi potreban
- HU Szükséges részek
- SV Delar som behövs
- IT Parti occorrenti
- PL Niezbędne elementy
- RO Elementele componente necesare
- BG Необходими части
- TR Gereklı parçalar

VCA03	6	VRA07	2	VRA47	2
VCA04	2	VRA20	8	VRA48	2
VRA01	2	VJA01	11	VRA49	1
VRA02	2	VRA42	2	VRA50	2
VRA52	4	VRA43	2	VRA51	1
VRA04	4	VRA44	2	RJ	4
VRA05	1	VRA45	2	S1	74
VRA06	4	VRA46	2	S7	108

- EN All parts are clearly marked and care should be taken to use the correct one.
- FR Toutes les pièces sont clairement marquées et il faut veiller à utiliser la bonne.
- DE Alle Teile sind deutlich gekennzeichnet und es sollte darauf geachtet werden, das richtige zu verwenden.
- ES Todas las partes están claramente marcadas y se debe tener cuidado al usar la correcta.
- PT Todas as peças estão claramente marcadas e deve-se tomar cuidado para usar a correta.
- NL Alle onderdelen zijn duidelijk gemarkeerd en er moet voor worden gezorgd dat de juiste wordt gebruikt.
- CS Všechny části jsou jasně označeny a je třeba dbát na to, aby byly použity ty správné.
- SK Všetky časti sú zreteľne označené a je potrebné dbať na správne použitie.
- SL Vsi deli so jasno označeni in paziti je treba uporabiti pravega.
- HR Svi su dijelovi jasno označeni i treba paziti na upotrebu ispravnog.
- HU Minden alkatrészt egyértelműen jelölnek, és ügyeljen a helyes alkatrészek használatára.
- SV Alla delar är tydligt märkta och man bör vara noga med att använda rätt.
- IT Tutte le parti sono chiaramente contrassegnate e occorre usare cautela per utilizzare quella corretta.
- PL Wszystkie części są wyraźnie oznaczone i należy zachować ostrożność, aby użyć właściwej.
- RO Toate părțile sunt clar marcate și trebuie să aveți grijă să o utilizați pe cea corectă.
- BG Всички части са ясно маркирани и трябва да се внимава да се използва правилната.
- TR Tüm parçalar açıkça işaretlenmiştir ve doğru parçayı kullanmaya özen gösterilmelidir.



EN Centre band assembly Back

FR Ensemble de bande centrale Retour

DE Mittelbandbaugruppe Zurück

ES Conjunto de banda central Volver

**A** PT Montagem da faixa central Voltar

NL Middenbandmontage Achterkant

CS Sestava středového pásu Zpět

SK Zostava stredového pásu Späť

SL Sestavljanje sredinskega pasu Nazaj

HR Montaža središnjeg pojasa Natrag

HU Középsáv összeszerelése Vissza

SV Centerbandmontering Tillbaka

IT Assemblaggio della fascia centrale Indietro

PL Zespół taśmy środkowej Powrót

RO Asamblare bandă centrală Înapoi

BG Сглобяване на централната лента Назад

TR Orta bant düzeneği Geri

1

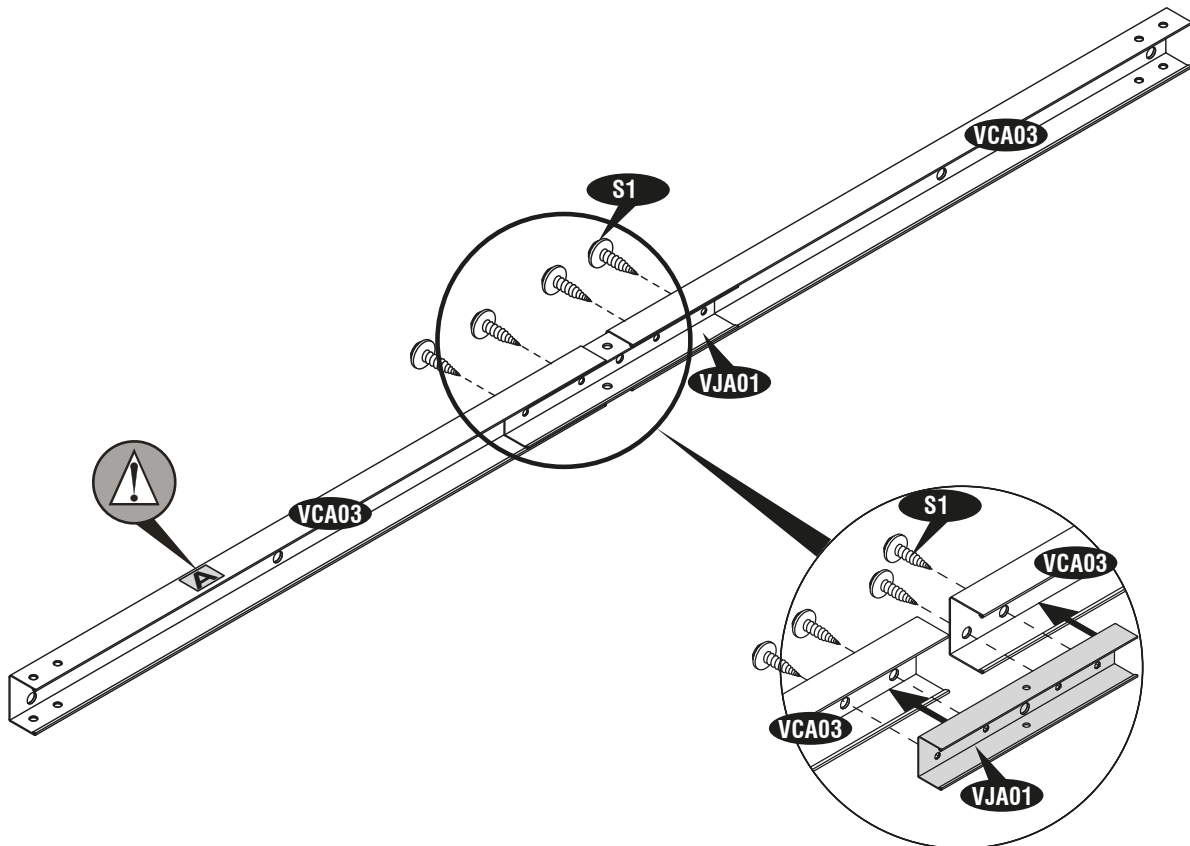
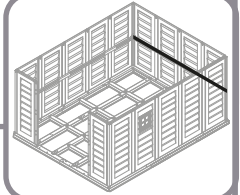
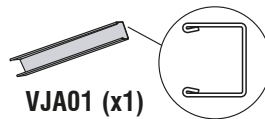
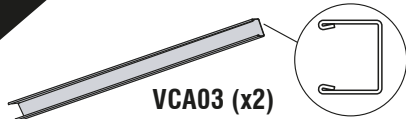

- EN Centre band assembly Left & Right
- FR Ensemble de bande centrale gauche et droite
- DE Mittelbandbaugruppe links und rechts
- ES Conjunto de banda central izquierda y derecha
- PT Montagem da faixa central esquerda e direita
- NL Middenband links en rechts
- CS Middenband links en rechts
- B** SK Zostava stredového pásu vľavo a vpravo
- SL Sestavljanje sredinskega pasu Levo in Desno
- HR Sastavljanje središnje trake Lijevo i Desno
- HU Középsáv összeszerelés bal és jobb
- SV Centerbandmontering vänster och höger
- IT Assemblaggio della fascia centrale sinistra e destra
- PL Zespół zespołu środkowego Lewy i prawy
- RO Adunarea benzilor centrale Stânga și Dreapta
- BG Сглобяване на централната лента наляво и надясно
- TR Orta bant grubu Sol ve Sağ



2

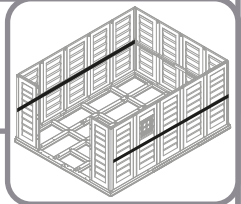
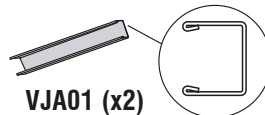
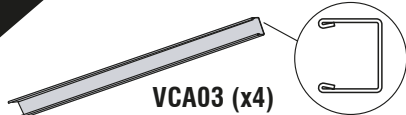

x2

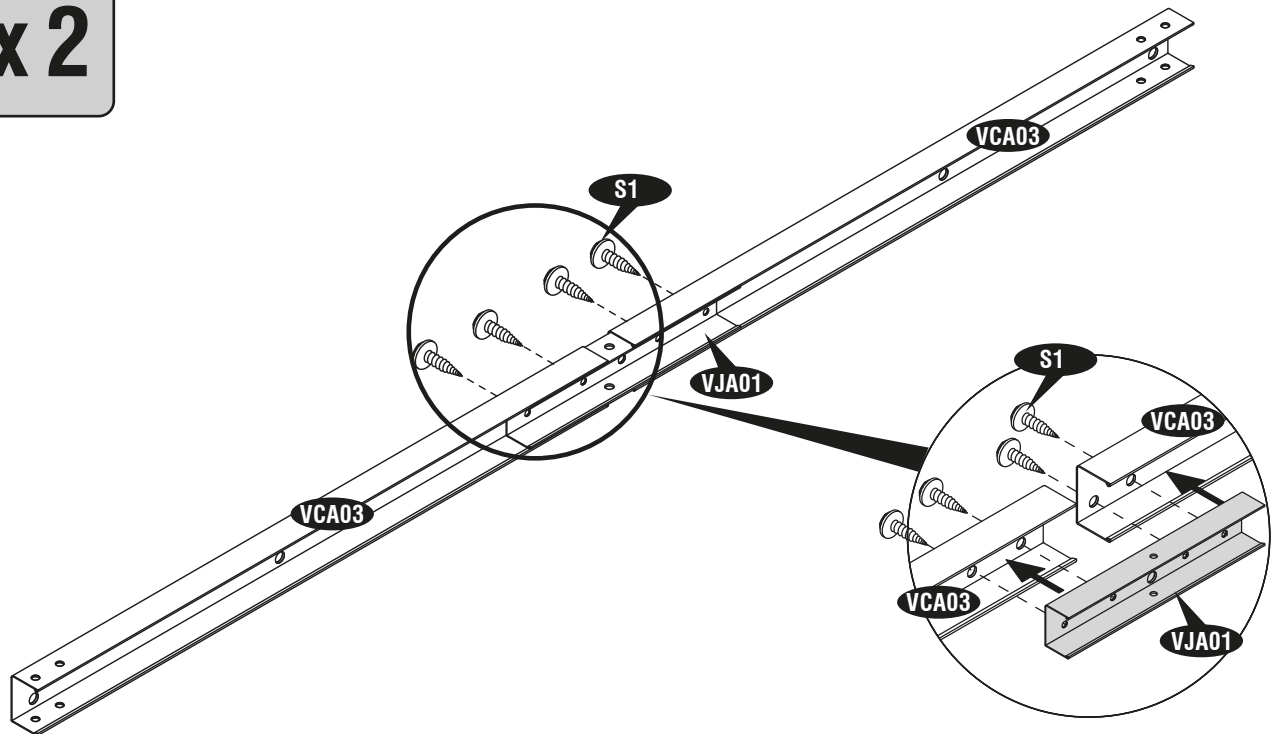

3

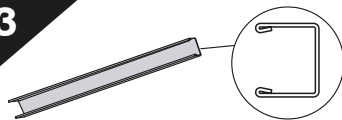

VCA04 (x2)

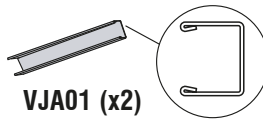

VJA01 (x2)



S1 (x6)

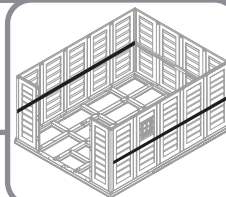

x2

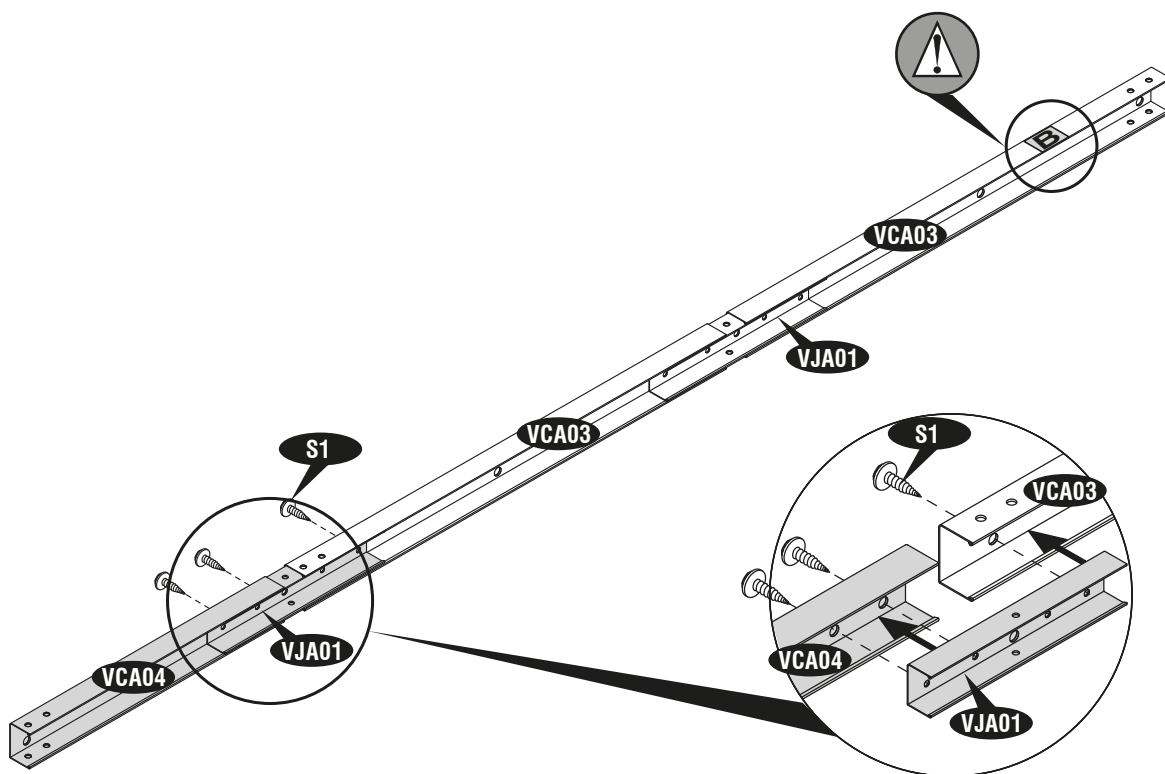

EN Front Roof Structure Assembly

FR Assemblage De La Structure Avant Du Toit

DE Vordere Dachkonstruktion Montage

ES Estructura de Asamblea de techo Frontal

C PT Armação da Estrutura do Telhado Frontal

NL Voorste dakconstructie montage kit

CS Montážní souprava přední střešní konstrukce

SK Montáž konštrukcie prednej strechy

SL Sestavni Del Prednje Strešne Konstrukcije

HR Prednja sklopa krovne konstrukcije

HU Első tetőszerkezet szerelvény

SV Frammonterad takkonstruktion

IT Assembled anteriore tetto della struttura

PL Montaż konstrukcji dachu przedniego

RO Frontul șarpanta Adunarea

BG Предна покривна конструкция събиране

TR Ön Çatı Yapısı Koamplesi

4

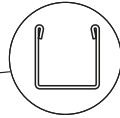

VRA01 (x1)

VRA02 (x1)



VJA01 (x1)

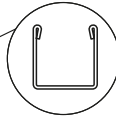

S1 (x4)

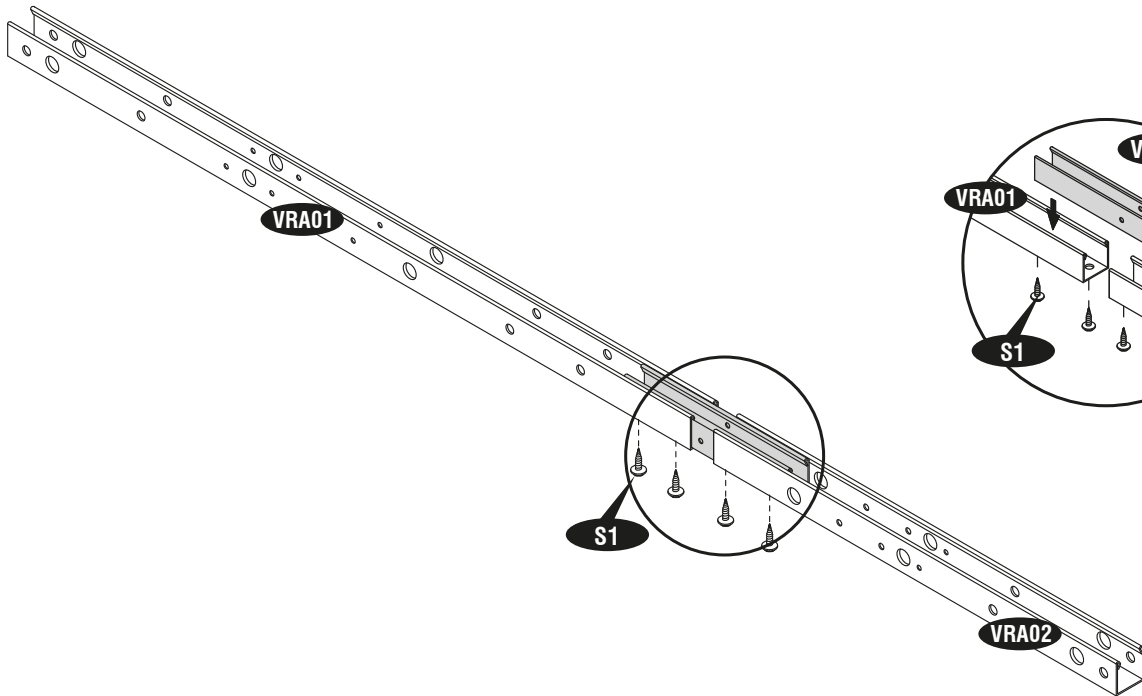
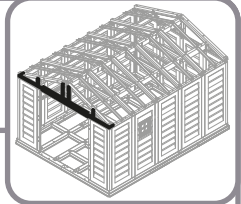

5

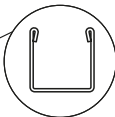

VRA04 (x2)

VRA52 (x2)



S1 (x6)

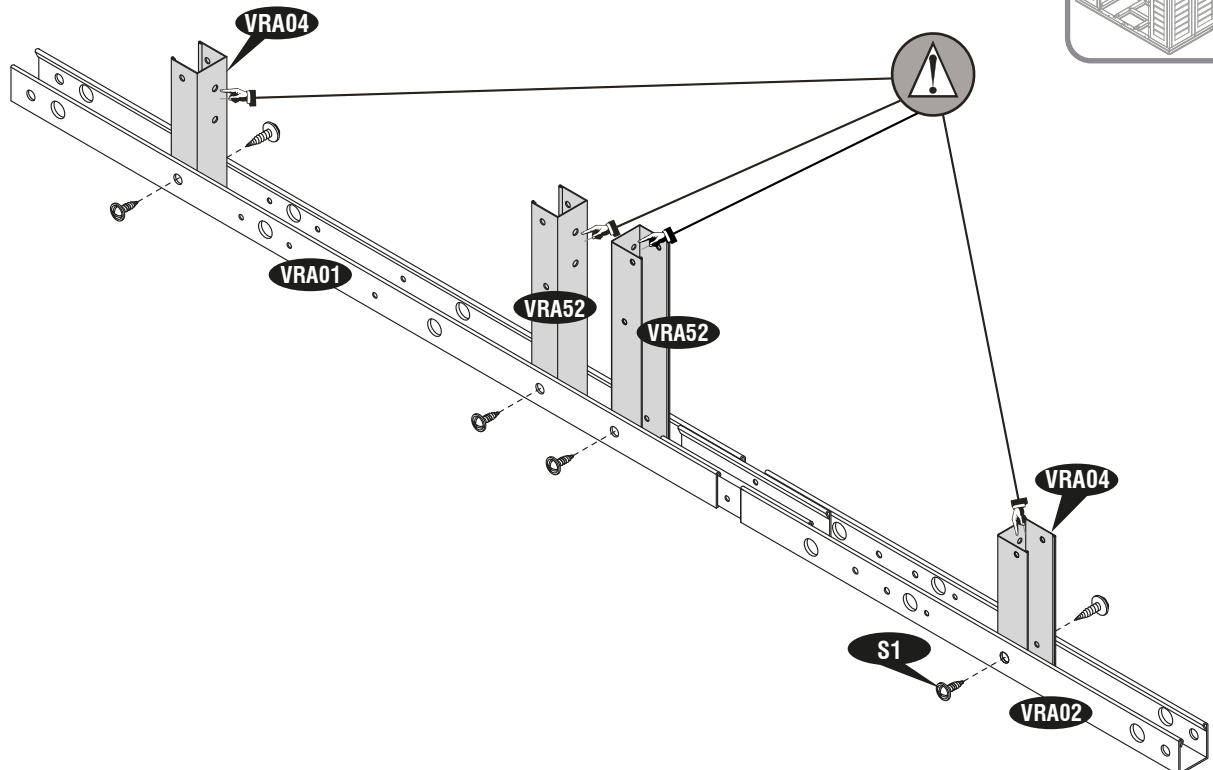
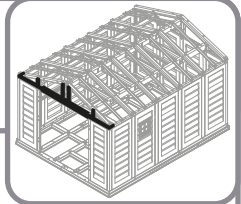



6

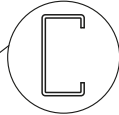
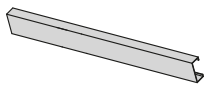

VRA05 (x1)



S1 (x6)

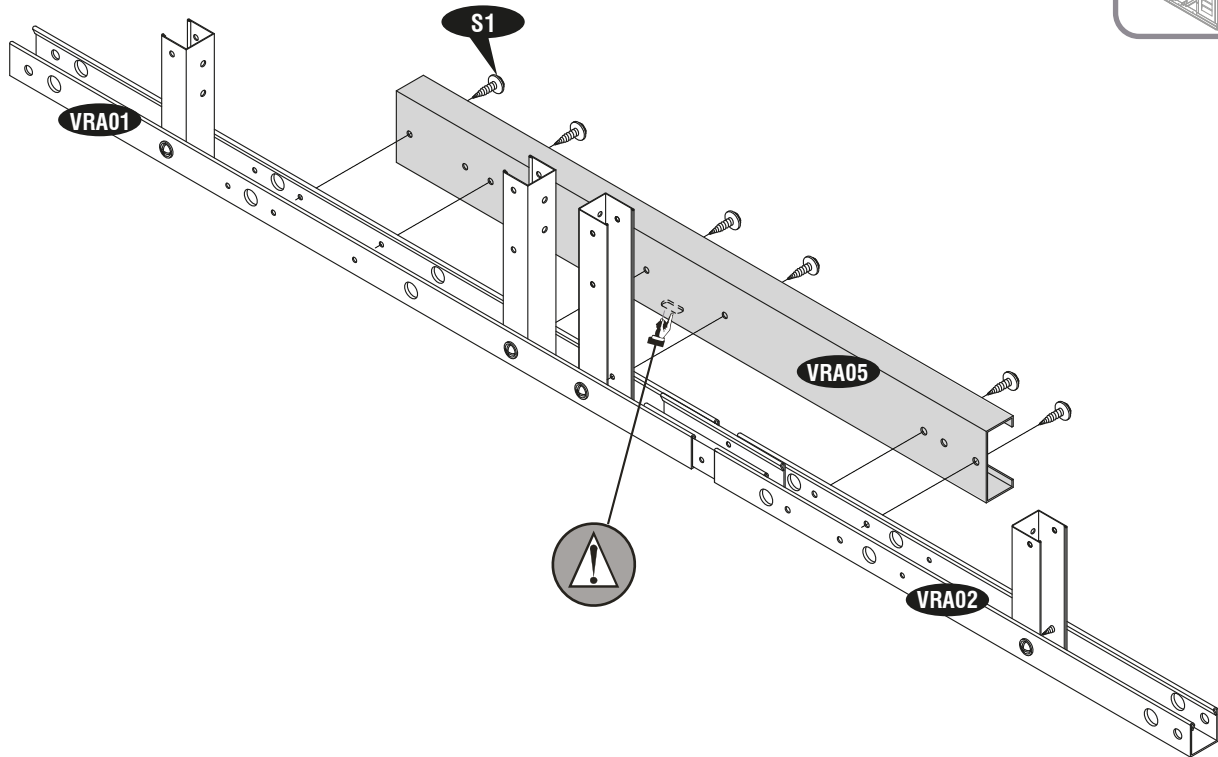
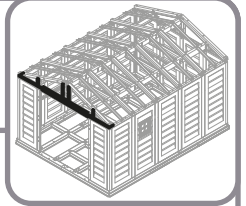

7

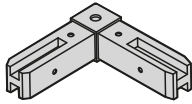

RJ (x2)



S1 (x2)

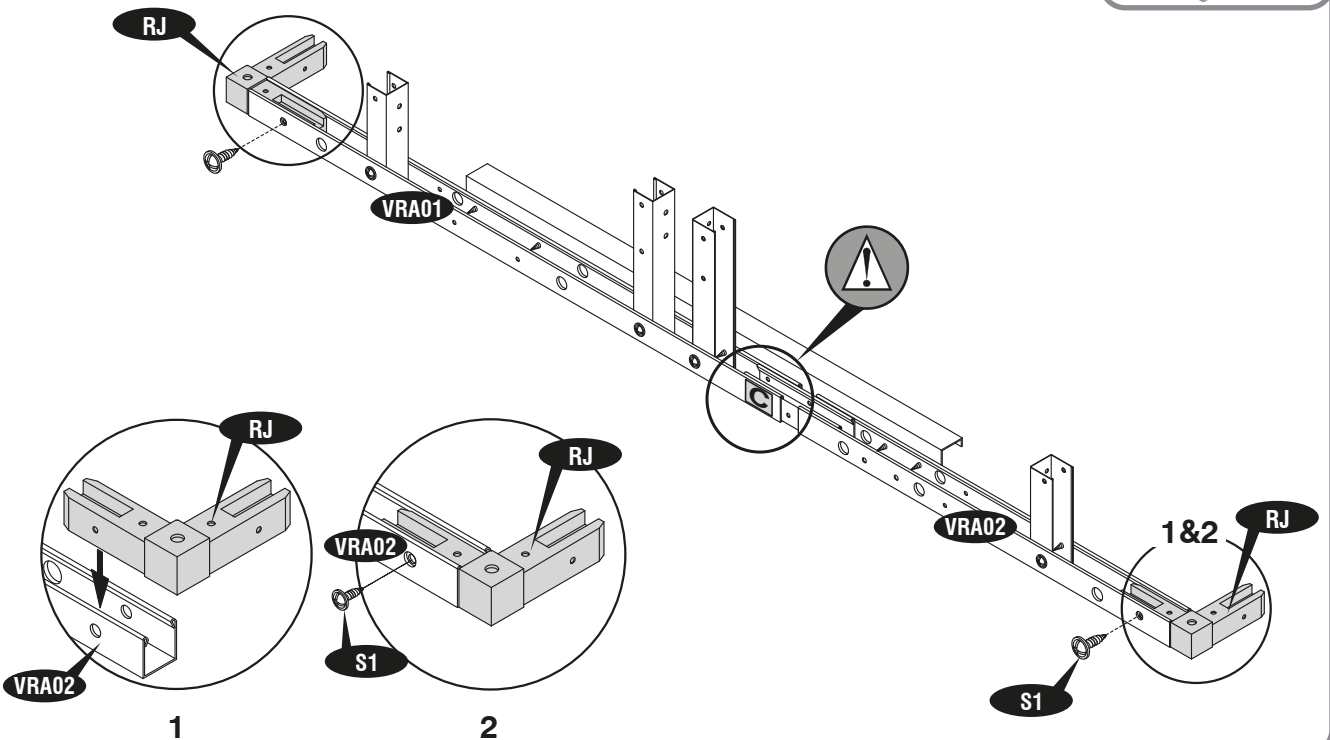
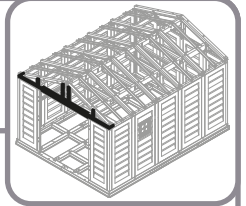

EN Back Roof Structure Assembly

FR Assemblage De La Structure Arriere Du Toit

DE Hintere Dachkonstruktion Montage

ES Estructura de montaje de techo trasera

PT Armação da Estrutura do Telhado Traseiro

NL Achter dakconstructie montage kit

CS Montážní souprava zadní střešní konstrukce

SK Zadné strešné konštrukcie Montáž

SL Sestavni Del Zadnje Strešne Konstrucije

HR Sastavni dio krovne strukture

HU Vissza Tetőszerkezet szerelvény

SV Bakre takkonstruktion

IT Assembla Struttura posteriore del tetto

PL Montaż tylnej konstrukcji dachu

RO Structura de asamblare Înapoi acoperiș

BG Структура събиране Обратно Покрив

TR Arka Çatı Yapısı Kompleksi

D

8

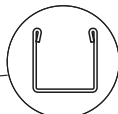

VRA01 (x1)

VRA02 (x1)



VJA01 (x1)

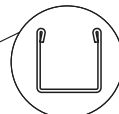

S1 (x4)

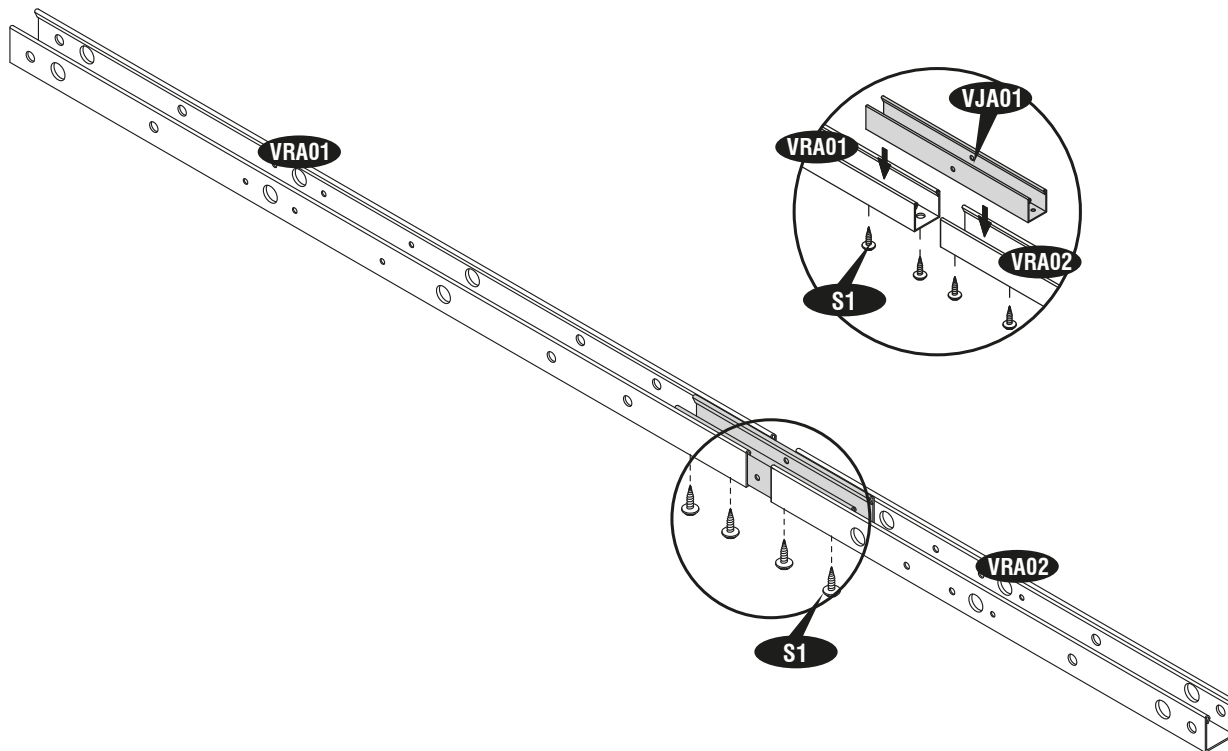
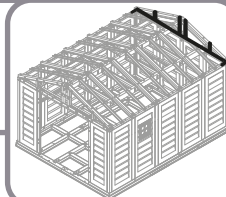

9

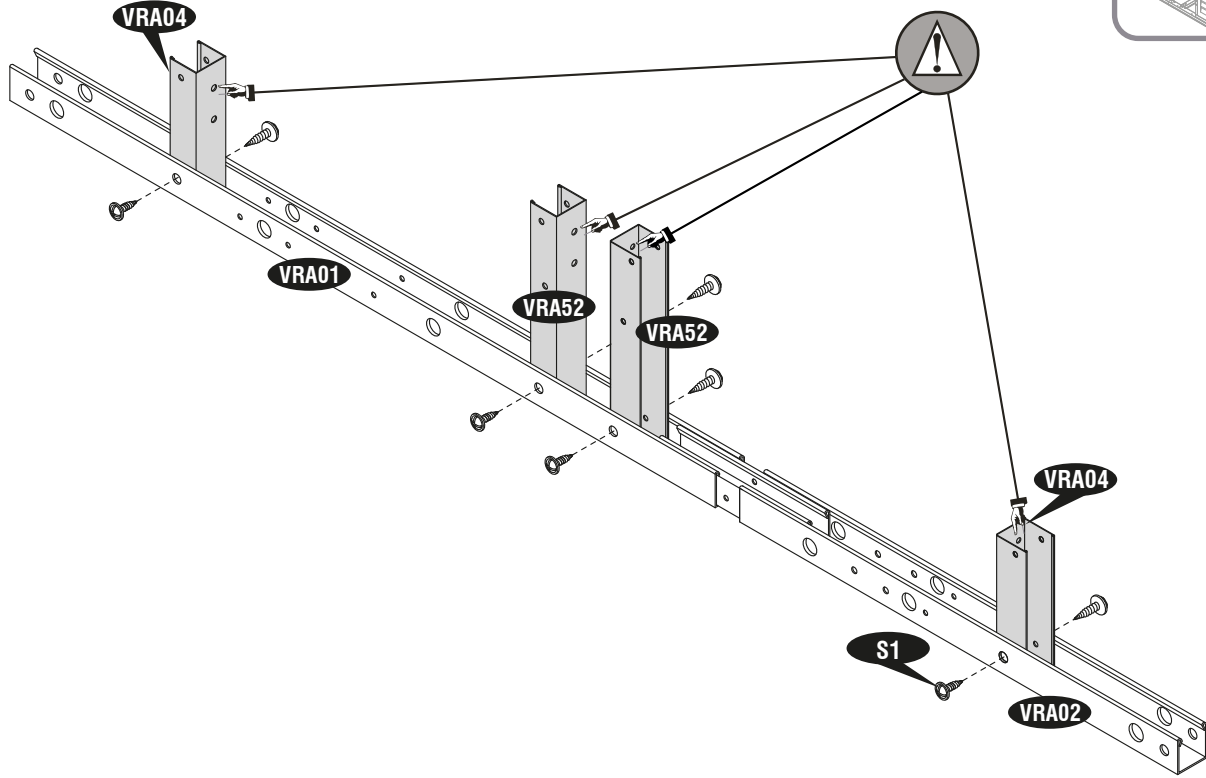
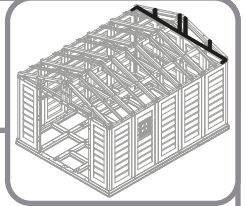
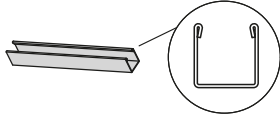

10

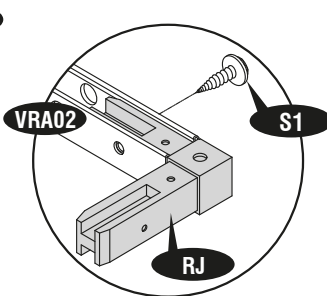
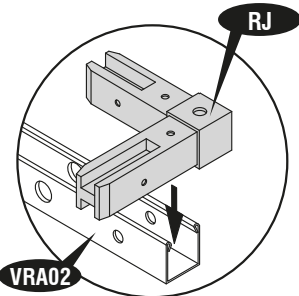
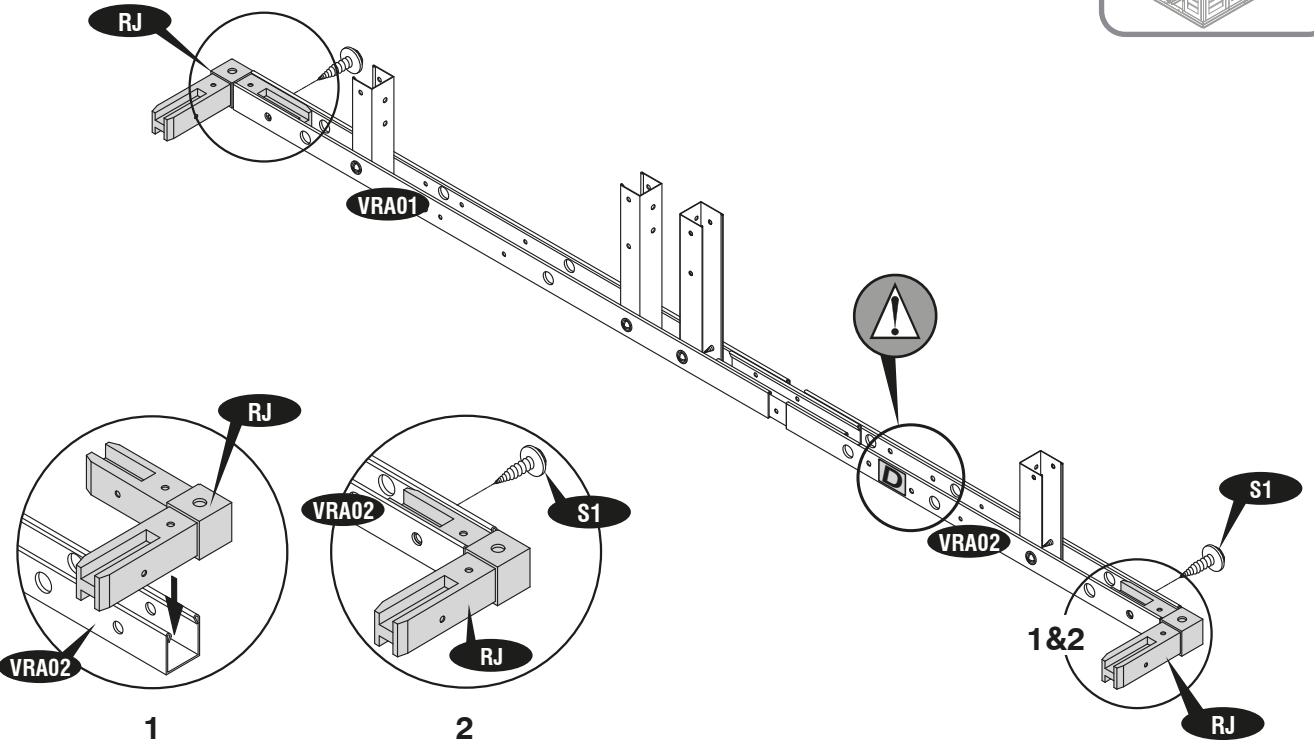
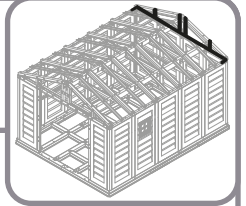
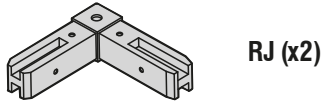

**E**

- EN Side Roof Structure Assembly Left & Right
- FR Ensemble de structure de toit latéral gauche et droit
- DE Seitliche Dachkonstruktion links und rechts
- ES Conjunto de estructura de techo lateral izquierda y derecha
- PT Montagem da estrutura do telhado lateral esquerda e direita
- NL Zijdakconstructie links en rechts
- CS Sestava boční střechy levá a pravá
- SK Zostava bočnej strechy vľavo a vpravo
- SL Sklop stranske konstrukcije strehe levo in desno
- HR Sklop bočne konstrukcije krova lijevo i desno
- HU Oldalsó tetőszerkezet balra és jobbra
- SV Sida takkonstruktion vänster och höger
- IT Assemblaggio della struttura del tetto laterale sinistro e destro
- PL Montaż bocznej konstrukcji dachu po lewej i prawej stronie
- RO Ansamblu structură laterală pentru acoperiș stânga și dreapta
- BG Монтаж на странична конструкция на покрива отляво и отдясно
- TR Yan Çatı Yapısı Kompleksi Sol ve Sağ



**11**

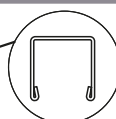

VRA06 (x4)

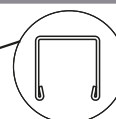
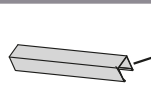

VJA01 (x2)

S1 (x4)

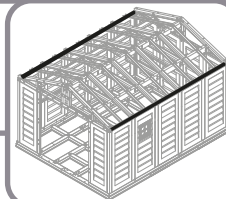

**x2**

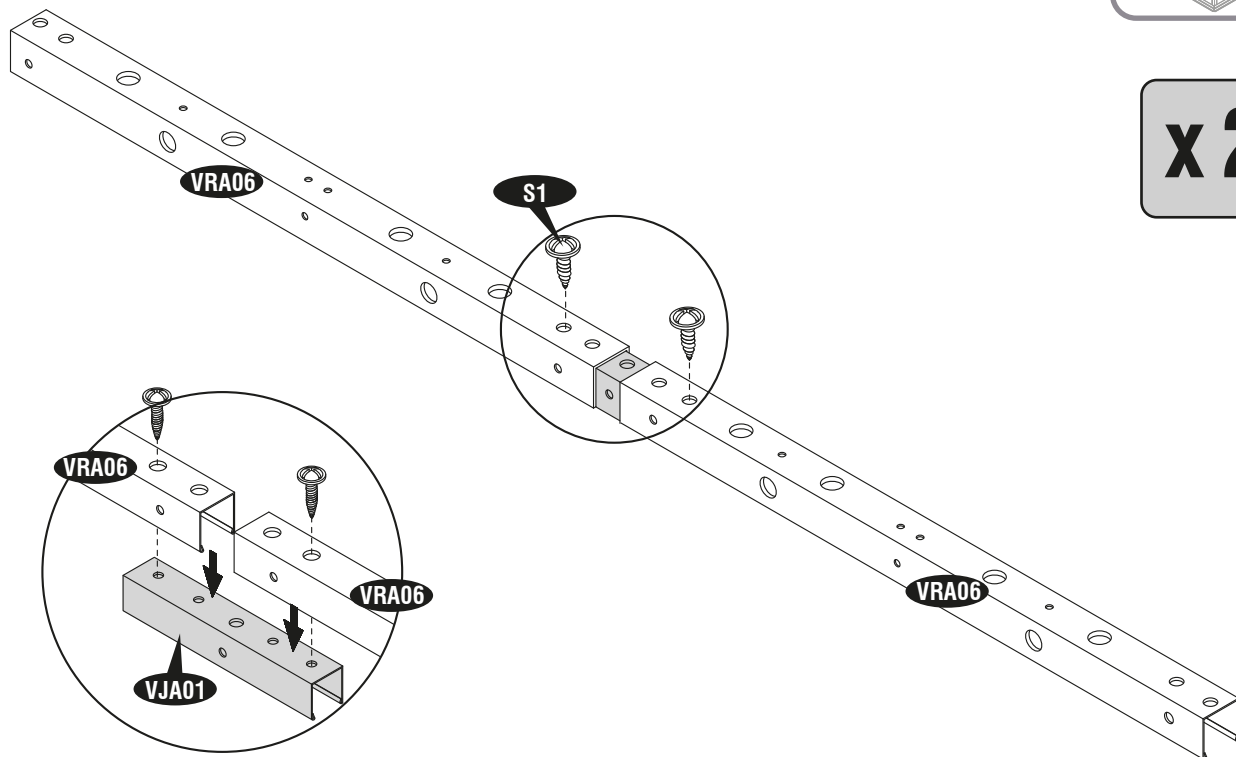

12

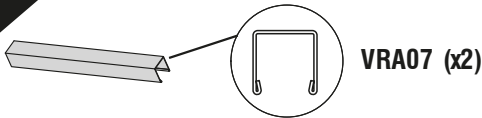

VRA07 (x2)

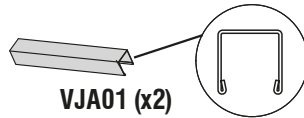

VJA01 (x2)



S1 (x4)

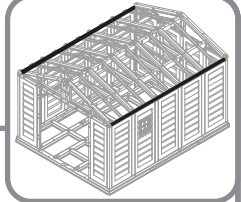

x2

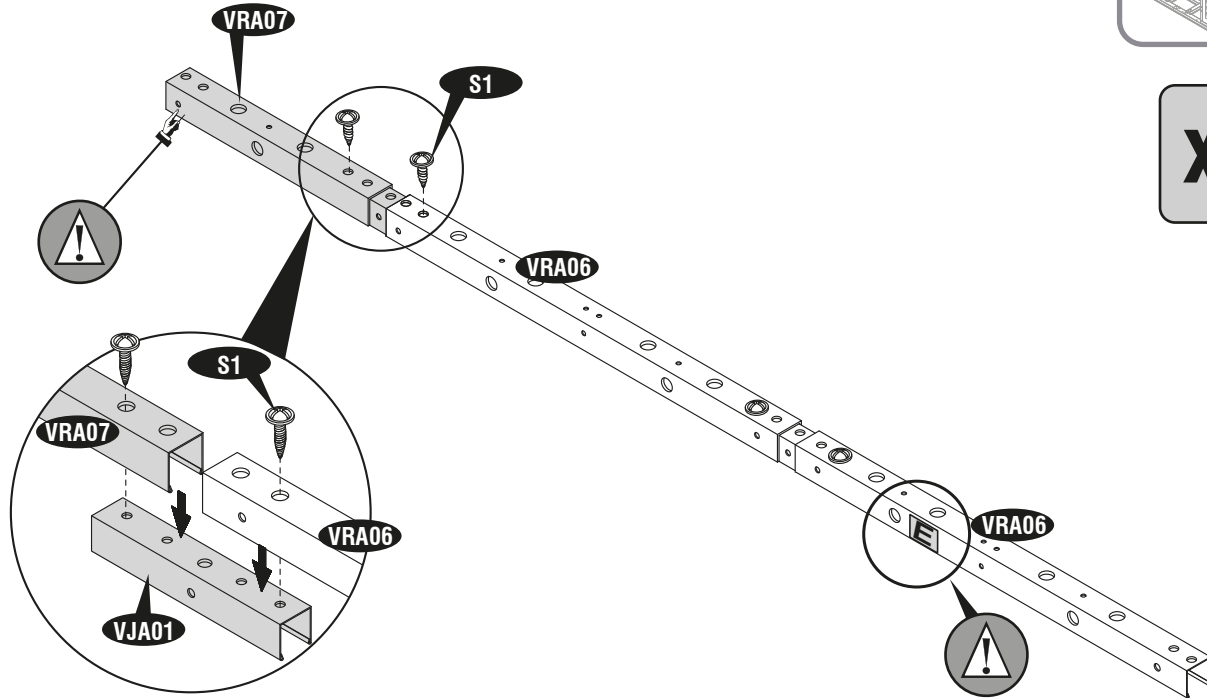

- F**
- EN Middle Roof Structure Assembly Inside
  - FR Ensemble de structure de toit gauche et droite à l'intérieur
  - DE Linke und rechte Dachkonstruktion innen
  - ES Montaje de estructura de techo izquierda y derecha en el interior
  - PT Conjunto da estrutura do telhado esquerdo e direito no interior
  - NL Links en rechts dakconstructie binnenin
  - CS Vnitřní sestava levé a pravé střešní konstrukce
  - SK Zostava vnútornej a ľavej strechy vnútri
  - SL Sklop leve in desne strešne konstrukcije v notranjosti
  - HR Sklop lijeve i desne konstrukcije krova iznutra
  - HU Bal és jobb tetőszerkezet belül
  - SV Vänster och höger takkonstruktion insida
  - IT Assemblaggio della struttura del tetto sinistro e destro all'interno
  - PL Zespół lewej i prawej konstrukcji dachu wewnątrz
  - RO Ansamblul structurii acoperișului stânga și dreapta în interior
  - BG Монтаж на ляв и десен покрив отвътре
  - TR İç Sol ve Sağ Çatı Yapısı Kompleksi

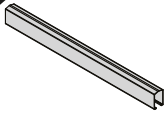

VRA48 (x2)  
VRA49 (x1)

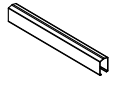

VRA50 (x2)  
VRA51 (x1)



S7 (x56)

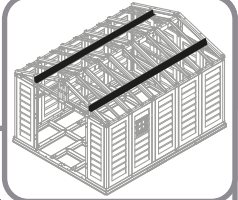

- EN Inserting method
- FR Méthode d'insertion
- DE Einfügemethode
- ES Método de inserción
- PT Método de inserção
- NL Methode invoegen
- CS Metoda vkládání
- SK Metóda vkladania
- SL Način vstavljanja
- HR Metoda umetanja
- HU Beillesztési módszer
- SV Infogningsmetod
- IT Metodo di inserimento
- PL Metoda wstawiania
- RO Metoda de introducere
- BG Метод на поставяне
- TR Ekleme yöntemi

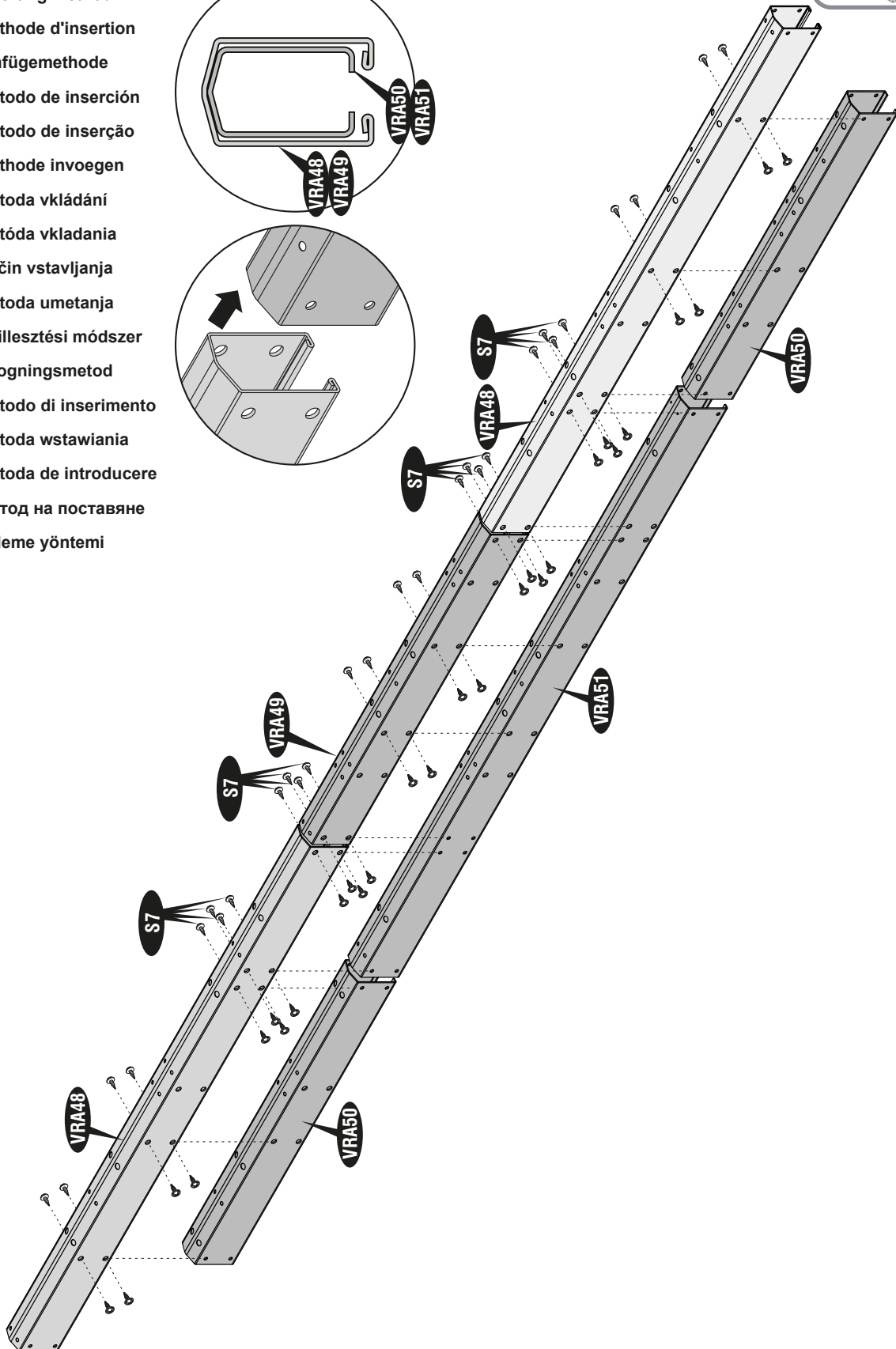
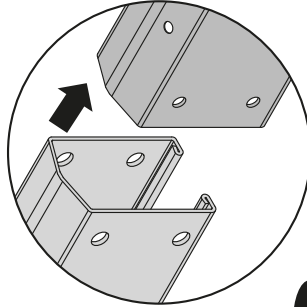
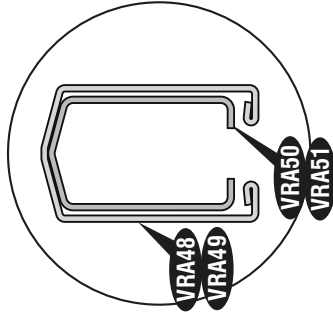



- G**
- EN Left & Right Roof Structure Assembly Inside
  - FR Ensemble de structure de toit gauche et droite à l'intérieur
  - DE Linke und rechte Dachkonstruktion innen
  - ES Montaje de estructura de techo izquierda y derecha en el interior
  - PT Conjunto da estrutura do telhado esquerdo e direito no interior
  - NL Links en rechts dakconstructie binnenin
  - CS Vnitřní sestava levé a pravé střešní konstrukce
  - SK Zostava vnútornej a ľavej strechy vnútri
  - SL Sklop leve in desne strešne konstrukcije v notranjosti
  - HR Sklop lijeve i desne konstrukcije krova iznutra
  - HU Bal és jobb tetőszerkezet belül
  - SV Vänster och höger takkonstruktion insida
  - IT Assemblaggio della struttura del tetto sinistro e destro all'interno
  - PL Zespół lewej i prawej konstrukcji dachu wewnątrz
  - RO Ansamblul structurii acoperișului stânga și dreapta în interior
  - BG Монтаж на ляв и десен покрив отвътре
  - TR İç Sol ve Sağ Çatı Yapısı Kompleksi

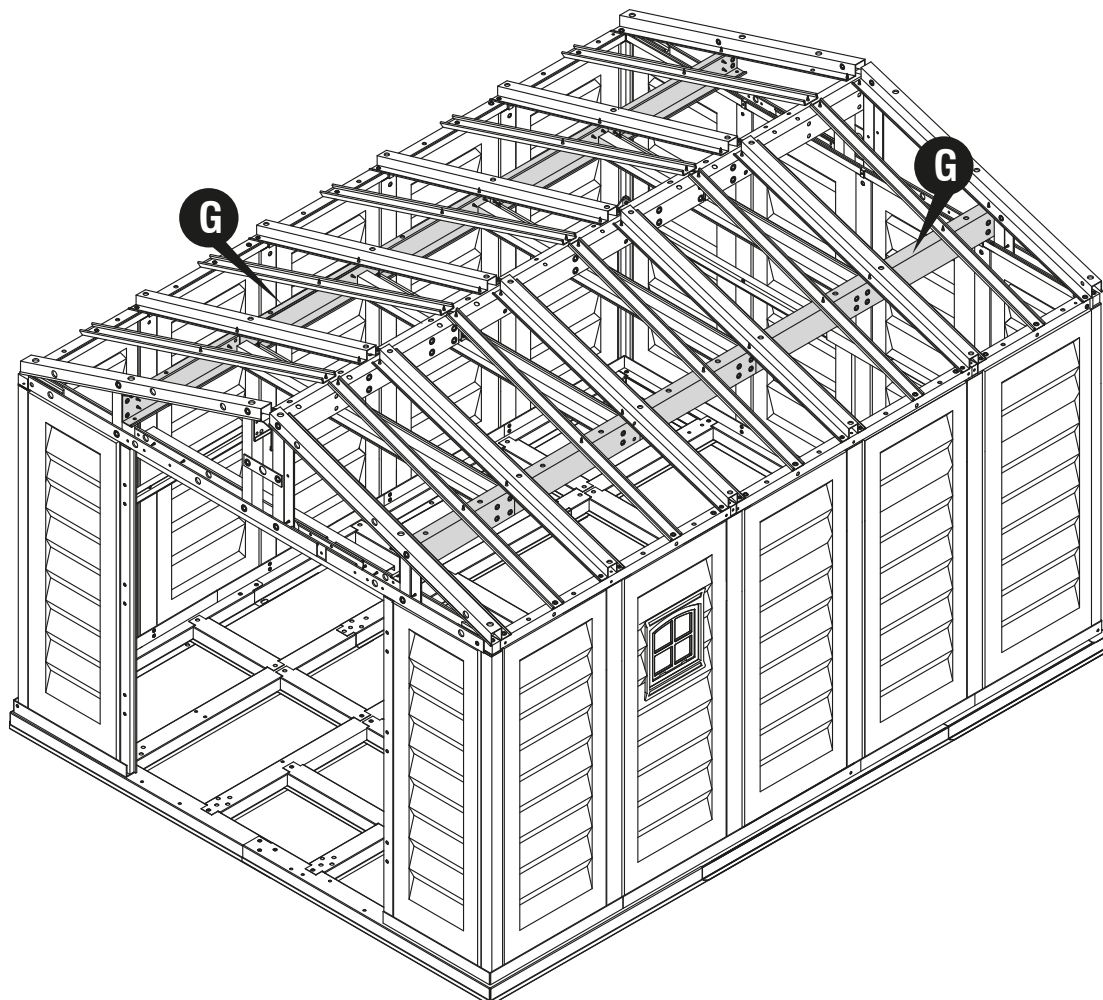

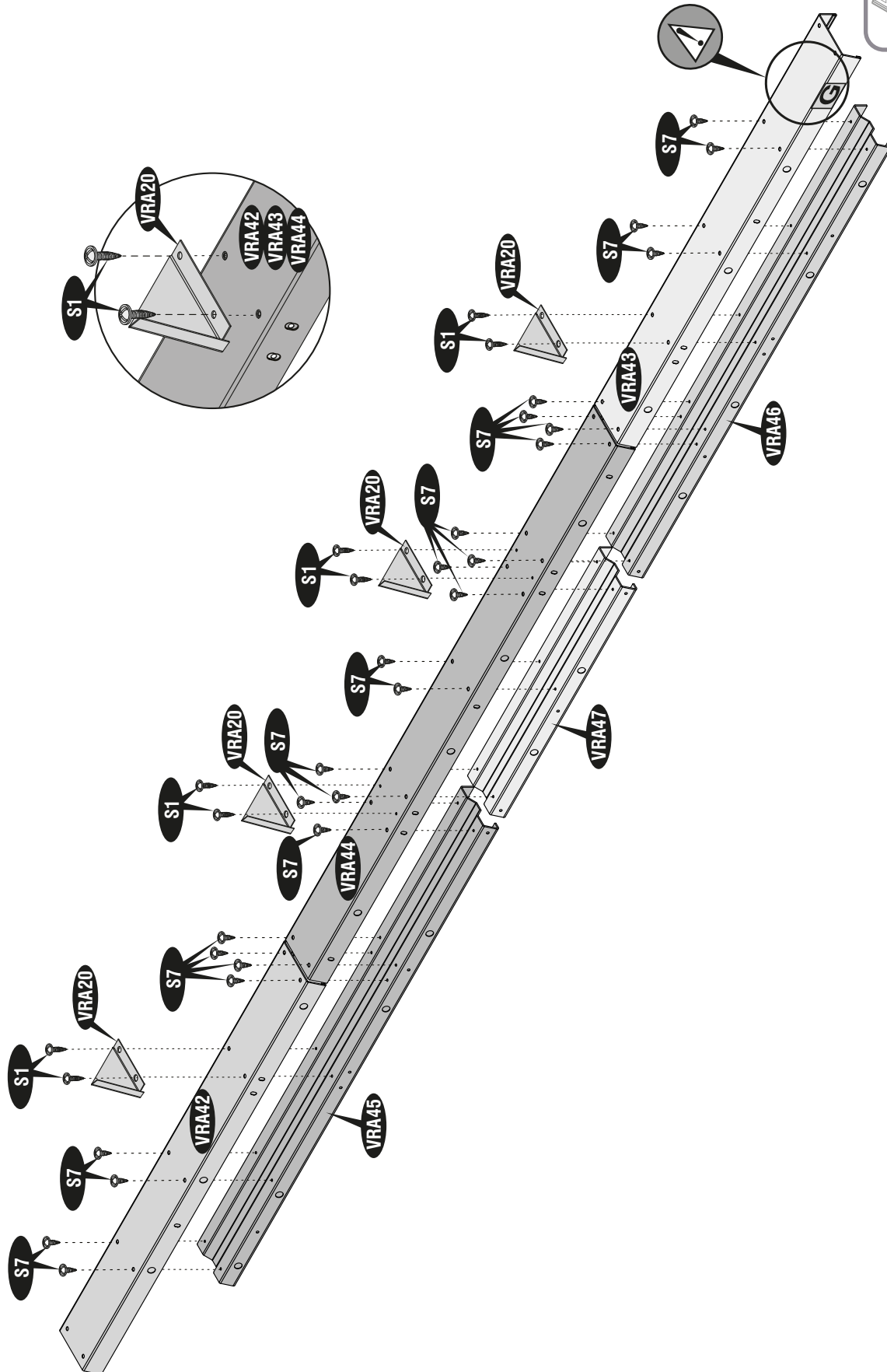
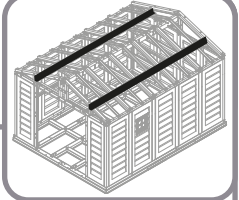
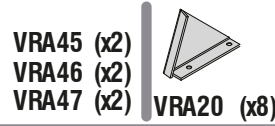
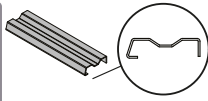
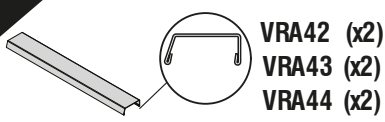

x2



- 4**
- |                       |                      |                        |
|-----------------------|----------------------|------------------------|
| EN Walls & Columns    | CS Zdi a kolumny     | IT Pareti & Colonne    |
| FR Murs et colonnes   | SK Steny a stĺpy     | PL Ściany i Kolumny    |
| DE Wände und Säulen   | SL Stene in stebri   | RO Pereți și stâlpi    |
| ES Columnas y paredes | HR Zidovi i Kolumne  | BG Стени & Колони      |
| PT Paredes e Colunas  | HU Falak és oszlopok | TR Duvarlar & Sütunlar |
| NL Panelen en stijnen | SV Väggar & Kolumner |                        |

- |                       |                                   |                                   |
|-----------------------|-----------------------------------|-----------------------------------|
| EN Parts needed       | CS Potřebné součásti              | IT Parti occorrenti               |
| FR Pièces nécessaires | SK Potrebne časti                 | PL Niezbędne elementy             |
| DE Benötigte Teile    | SL Dele, ki jih boste potrebovali | RO Elementele componente necesare |
| ES Piezas necesitadas | HR Dijelovi potreban              | BG Необходими части               |
| PT Peças Necessárias  | HU Szükséges részek               | TR Gereklî parçalar               |
| NL Onderdelen nodig   | SV Delar som behövs               |                                   |

CLA1	1	B	2	CBC	5
CLA2	4	VCA01	2	EPS	2
CLA3	11	WPA1↑	15	S1	59
CLA4	1	WPA2↑	1	S2	4
A	1	FCB	4		



- EN One shatter proof window panel (WPA2↑) included. This can be used in any of the wall positions.
- FR Une panneau de fenêtre incassable (WPA2↑) inclus.Ceci peut être utilisé dans toutes les positions de mur.
- DE Ein bruchsichere Fensterscheibe (WPA2↑) enthalten.Dies kann in jeder der Wandpositionen verwendet werden.
- ES Una panel de la ventana irrompible (WPA2↑) incluido.Esto se puede utilizar en cualquiera de las posiciones de la pared.
- PT Painel da janela da prova de uma fragmentos (WPA2↑) incluído. Isso pode ser usado em qualquer uma das posições da parede.
- NL Inclusief een splintervrije vensterpanelen (WPA2↑). Dit kan in elk van de muurposities worden gebruikt.
- CS K dispozici jsou jeden okna odolná proti rozbití (WPA2↑). To lze použít v libovolné zdi.
- SK Súčasťou dodávky sú aj jeden priehradové okná (WPA2↑). Môžete ho použiť v ľubovoľnej stene.
- SL Vključeni so eno razbiti dokazni okenski pokrovi (WPA2↑). To lahko uporabite v katerem koli položaju stene.
- HR Uključeno je jedan protuprovalna prozorska ploča (WPA2↑). To se može koristiti na bilo kojem mjestu zida.
- HU Egy törésbiztos ablakpárnát (WPA2↑) tartalmaz. Ezt bármilyen falpozícióban lehet használni.
- SV Ett spjällsakerhetsfönster (WPA2↑) ingår. Detta kan användas i någon av väggpositionerna.
- IT Una pannelli per finestre a prova di esplosione (WPA2↑) inclusi. Questo può essere utilizzato in qualsiasi posizione del muro.
- PL W komplecie jeden odporne na rozbięcie szyby (WPA2↑). Można go użyć w dowolnej pozycji na ścianie.
- RO Sunt incluse unu panouri de ferestre (WPA2↑). Acest lucru poate fi folosit în orice poziție a peretelui.
- BG Включени са и един прозоречни панела (WPA2↑). Това може да се използва във всяка от стените.
- TR Bir paramparça geçirmez pencere paneli (WPA2↑) dahildir. Bu, duvar konumlarından herhangi birinde kullanılabilir.

EN Column & Panel Assembly method

FR Colonne et méthode de montage panneau

DE Montageverfahren für Säulen und Paneele

ES Columna y el método de montaje de Panel

PT Método de montagem de colunas e painéis

NL Kolom en paneelmontage methode

CS Metoda sestavení sloupců a panelů

SK Metóda zhrmažďovania stĺpcov a panelov

SL Metoda zbiranja stolpcev in plošč

HR Metoda montaže stupaca i panela

HU Az oszlop és a panel összeszerelési módszere

SV Kolonn- och panelmonteringsmetod

IT Metodo di assemblaggio di colonne e pannelli

PL Metoda montażu kolumn i paneli

RO Coloana & metoda de asamblare panou

BG Метод за сглобяване на колони и панели

TR Sütun ve Panel Montaj yöntemi

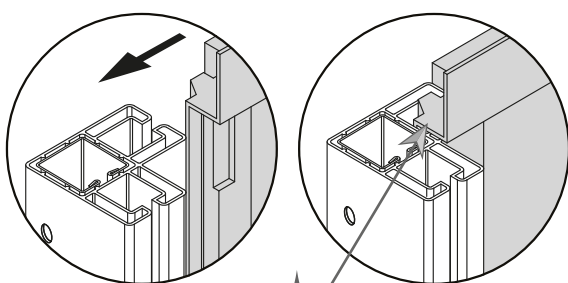

1

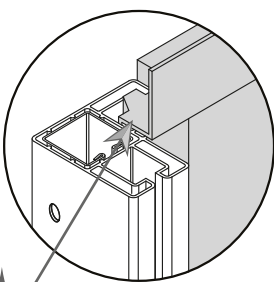

2

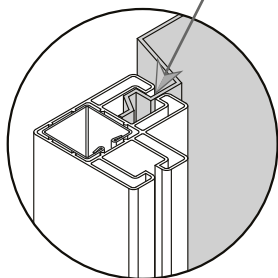

3

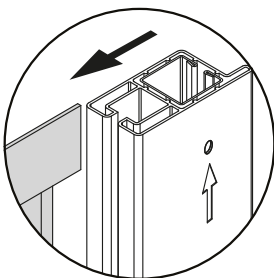

4

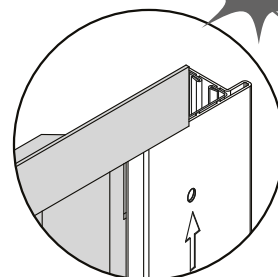

5

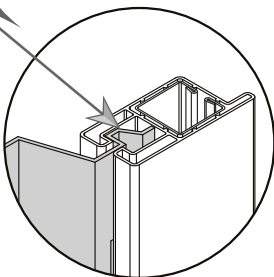

6

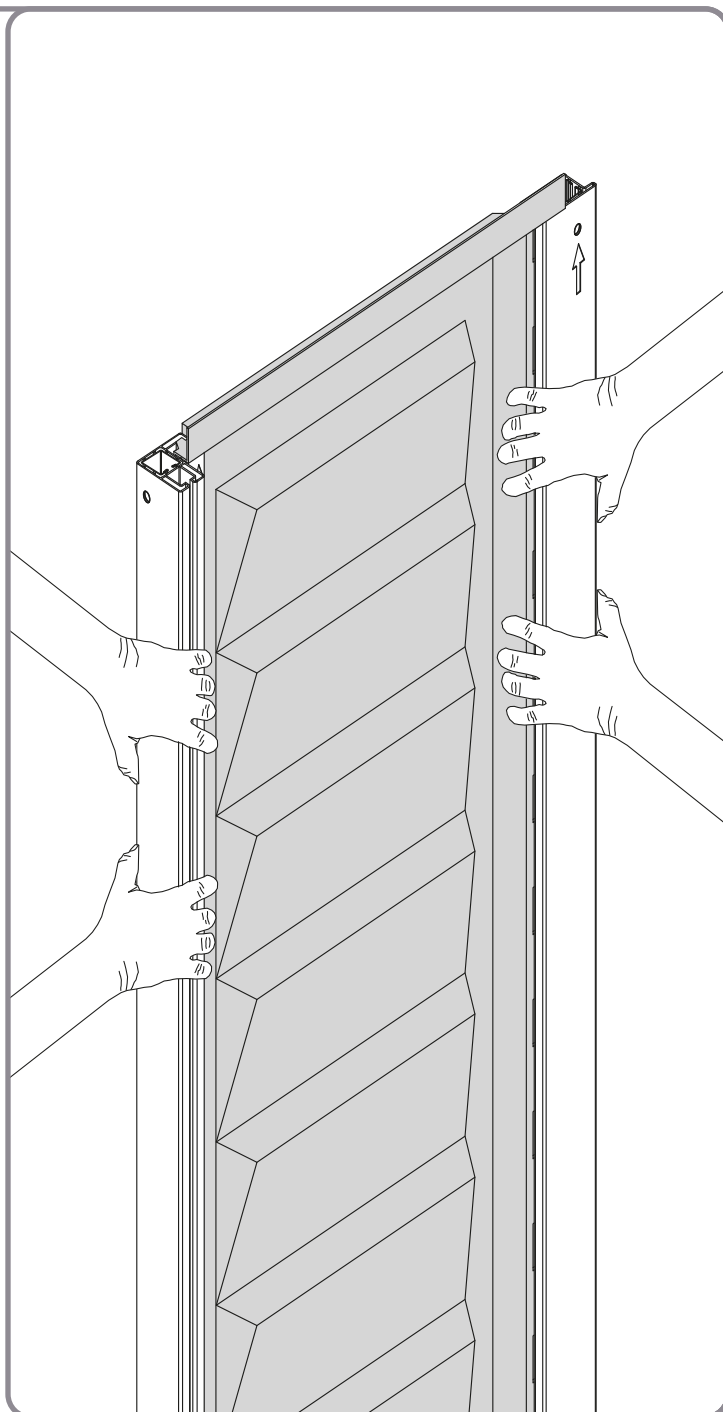



- EN Lock the panel into the column from top to bottom.
- FR Verrouiller le panneau dans la colonne de haut en bas.
- DE Verriegeln Sie das Panel von oben nach unten in die Säule.
- ES Trabe el panel en la columna de arriba a abajo.
- PT Método de montagem de colunas e painéis
- NL Kolom en paneelmontage methode.
- CS Metoda sestavení sloupců a panelů.
- SK Metóda zhromažďovania stĺpcov a panelov.
- SL Metoda zbiranja stolpcev in plošč.
- HR Metoda montaže stupaca i panela.
- HU Az oszlop és a panel összeszerelési módszere.
- SV Kolonn- och panelmonteringsmetod.
- IT Metodo di assemblaggio di colonne e pannelli.
- PL Zablokuj panel w kolumnie od góry do dołu.
- RO Coloana & metoda de asamblare panou.
- BG Метод за сглобяване на колони и панели.
- TR Sütun ve Panel Montaj yöntemi.



1

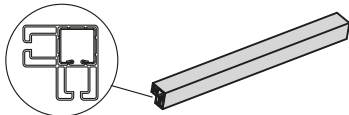

CLA2 (x1)



S1 (x2)

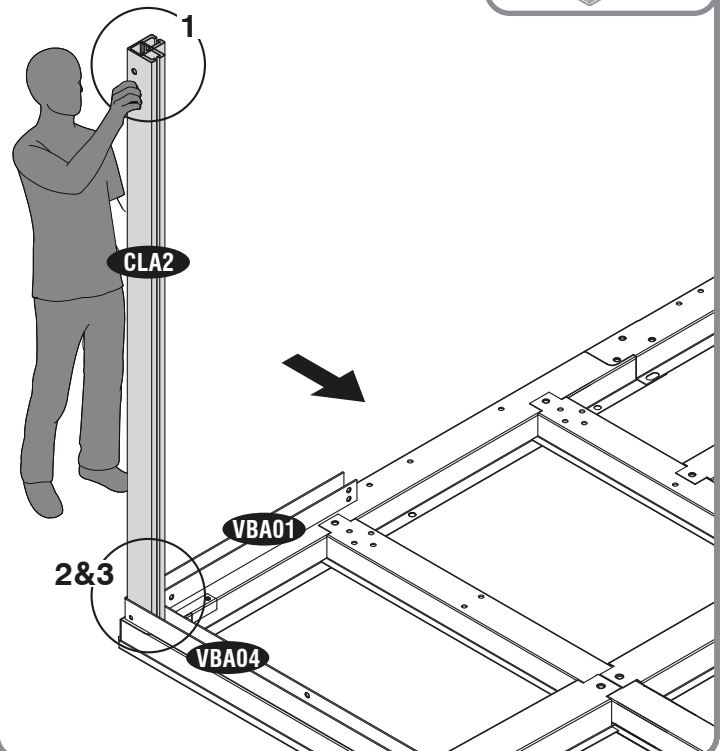
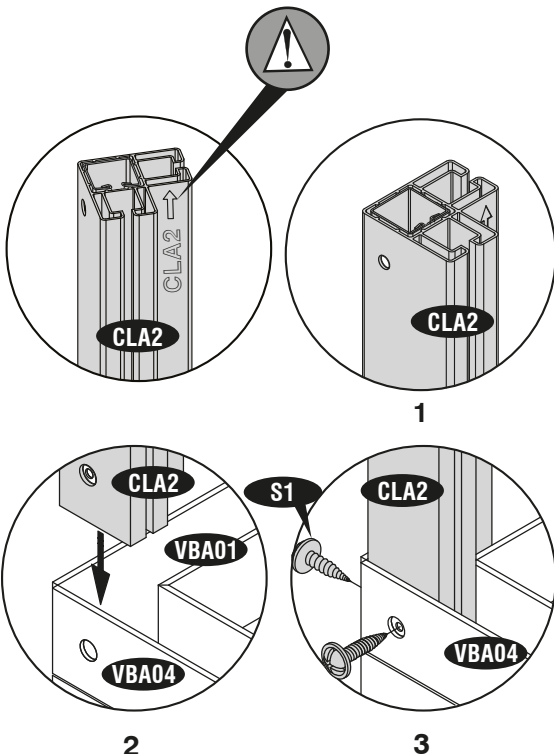
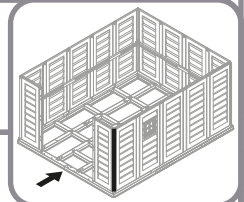



2

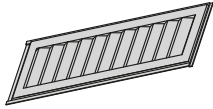

WPA1↑ (x1)

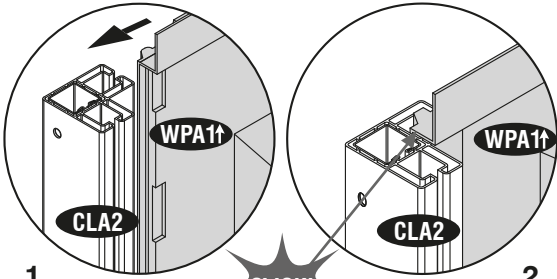
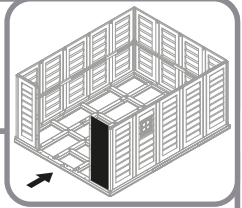

1

CLICK!

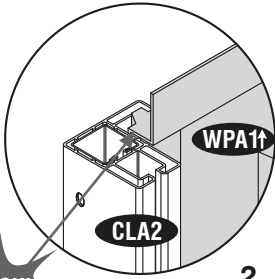

2

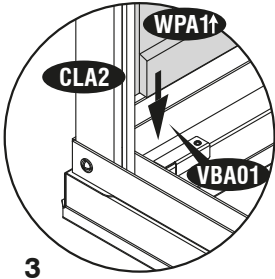

3

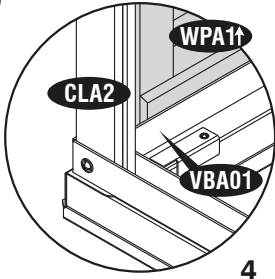

4

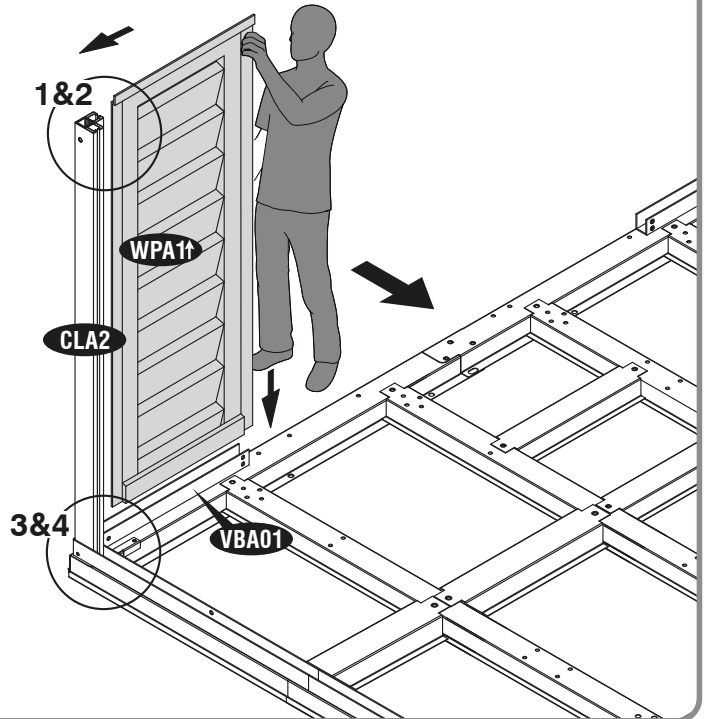

3

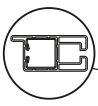

CLA1 (x1)



S1 (x2)

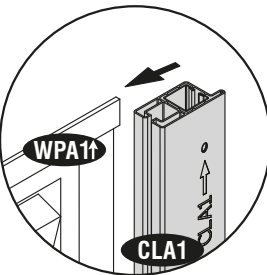
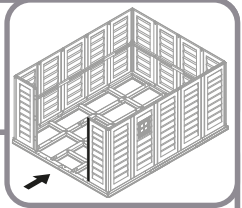

1

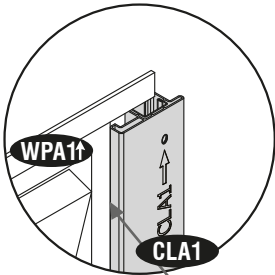

2

CLICK!

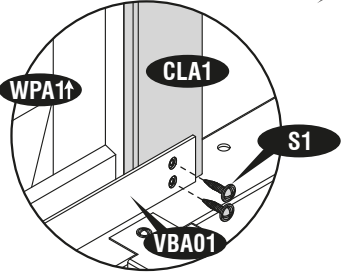

3

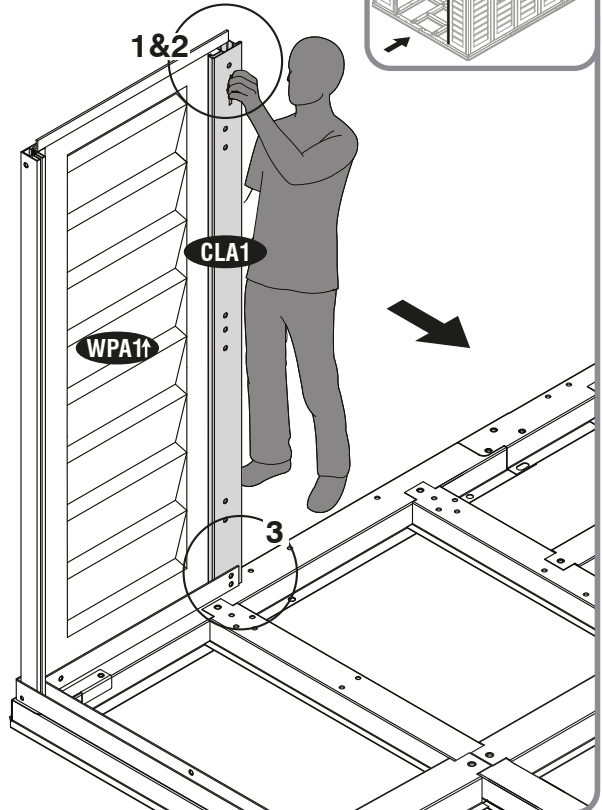



4

FCB(x1)

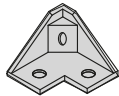

S2 (x1)

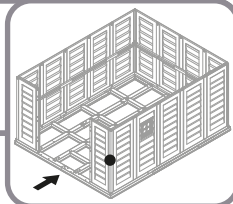

- EN Do not tighten the screw. Leave it loose.  
 FR Ne pas serrer la vis. Laissez-le lâche.  
 DE Ziehen Sie die Schraube nicht fest. Lass es locker.  
 ES No apriete el tornillo. Déjalo suelto.  
 PT Não aperte o parafuso. Deixe solto.  
 NL Draai de schroef niet vast. Laat het los.  
 CS Neutahujte šroub. Nechte to volné.  
 SK Skrutku neutiahnite. Nechajte to uvoľnené.  
 SL Ne privijajte vijaka. Pusti ga.  
 HR Nemojte zatezati vijak. Ostavite ga na slobodi.  
 HU Ne húzza meg a csavart. Hagyja laza.  
 SV Dra inte åt skruven. Lämna det löst.  
 IT Non stringere la vite. Lascialo libero.  
 PL Nie dokręcaj śruby. Pozostaw to luźne.  
 RO Nu strângeți șurubul. Lasă-l liber.  
 BG Не затягайте винта. Оставете го свободно.  
 TR Vidayı sıkmayın. Onu serbest bırak.

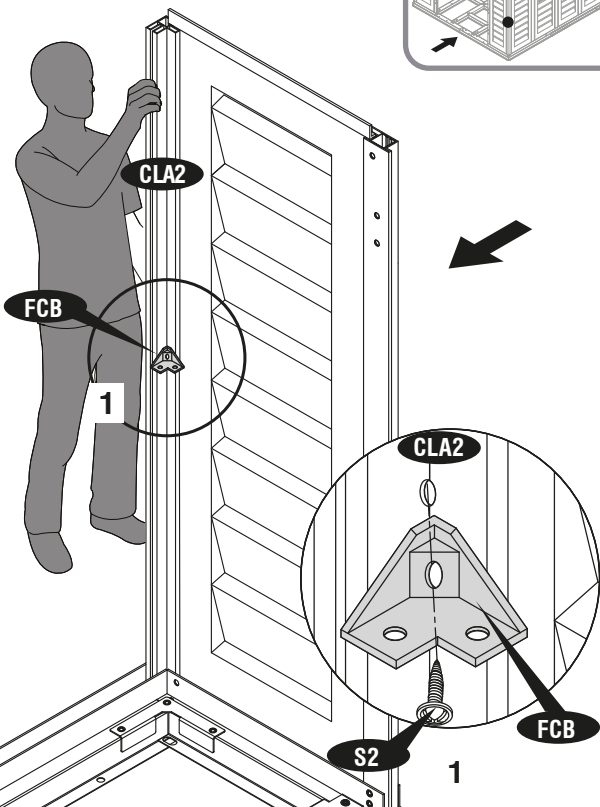

5

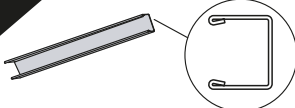

VCA01 (x1)



S1 (x2)

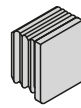

EPS (x1)

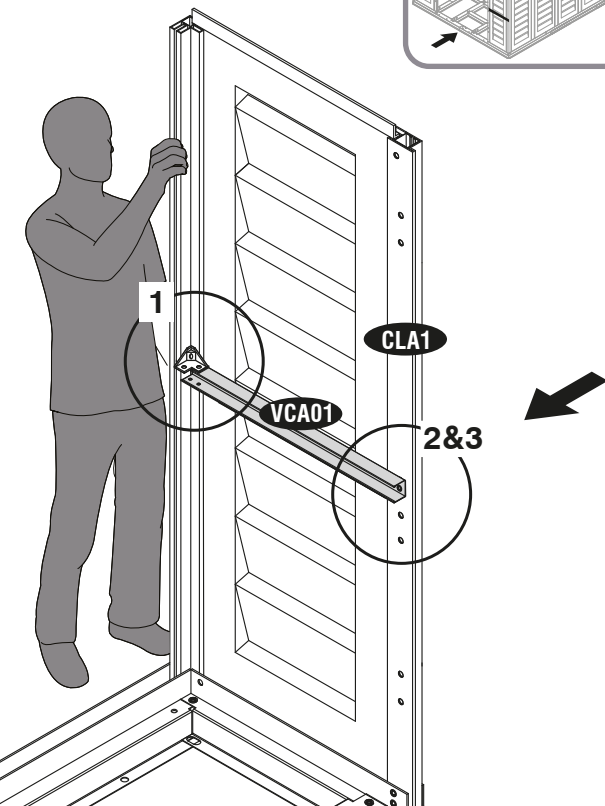
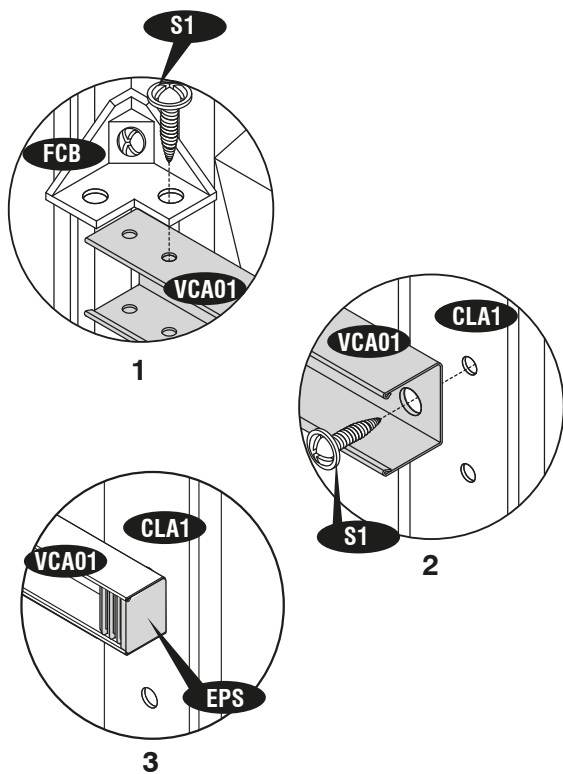
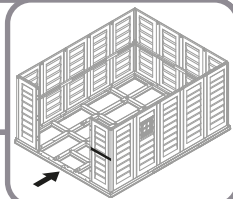

6

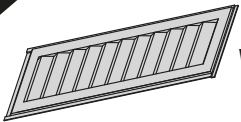

WPA1↑ (x1)



CLA3 (x1)



S1 (x2)

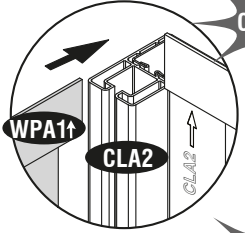
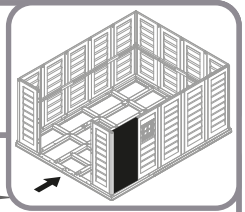

1

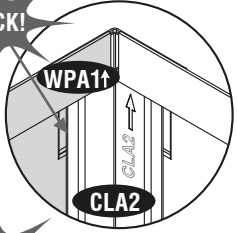

2

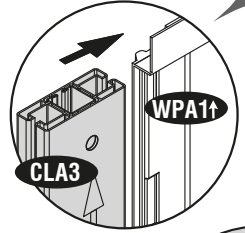

3

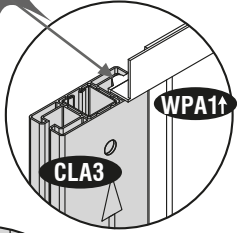

4

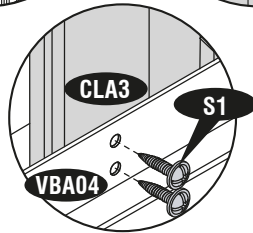

5

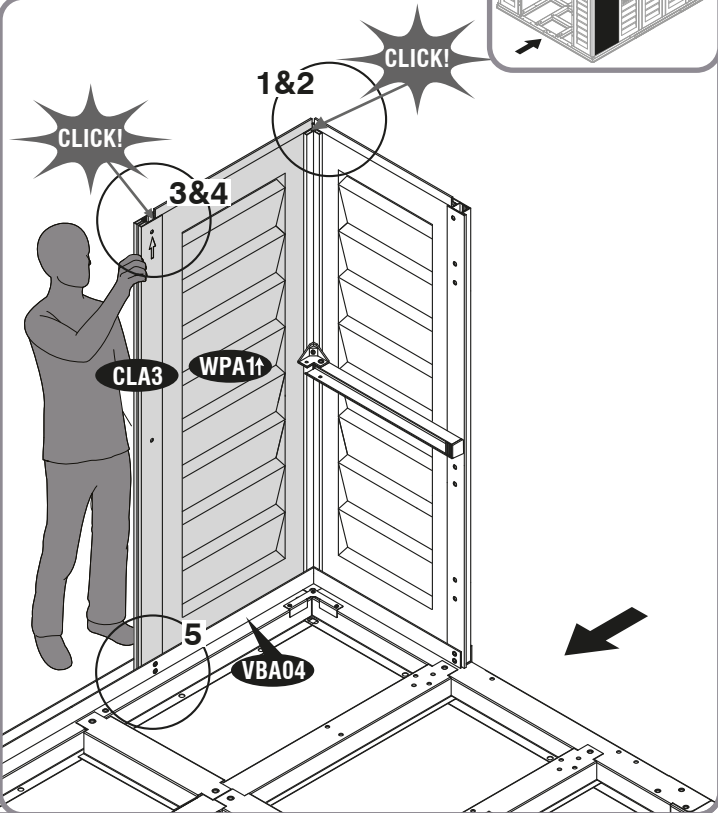

7

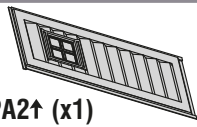

WPA2↑ (x1)



CLA3 (x1)



S1 (x2)

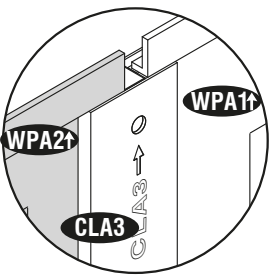
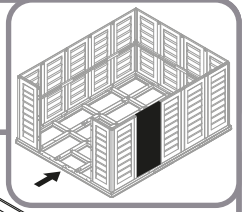

1

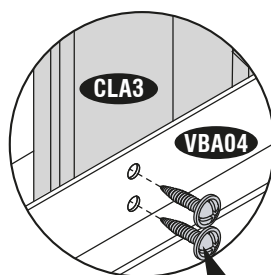

2

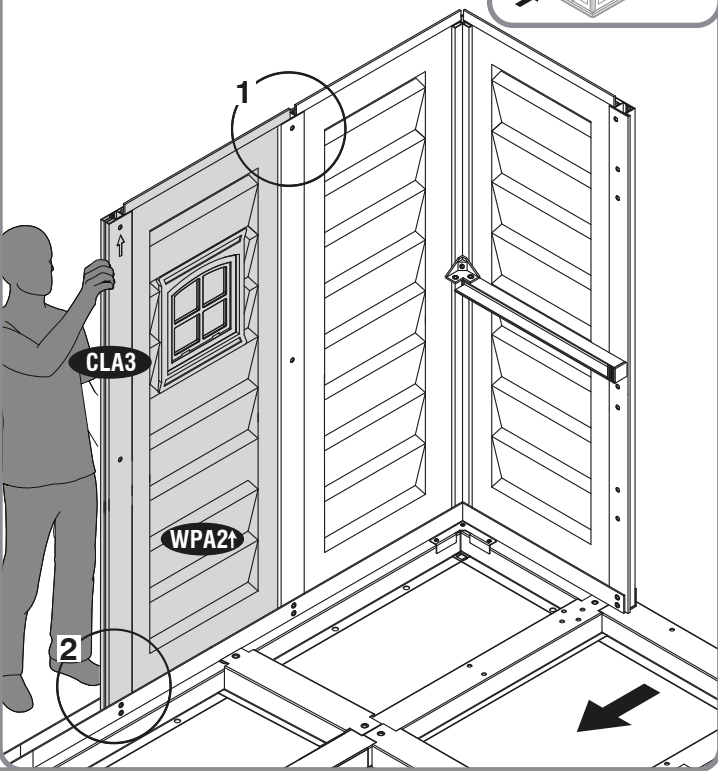

8

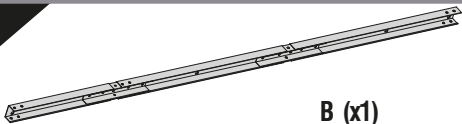

B (x1)

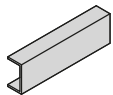

CBC (x1)



S1 (x4)

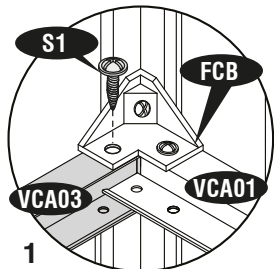
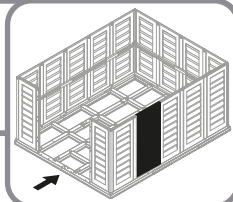

1

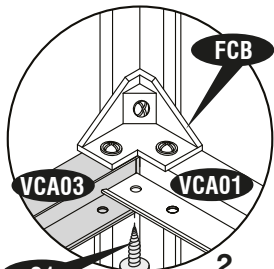

2

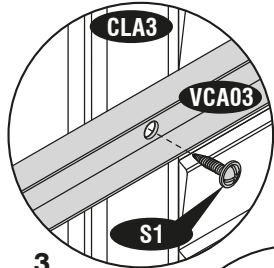

3

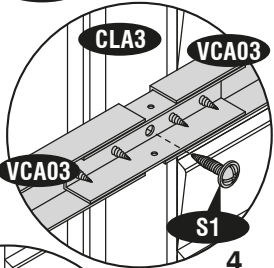

4

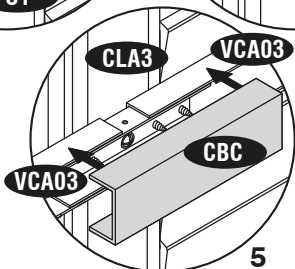

5

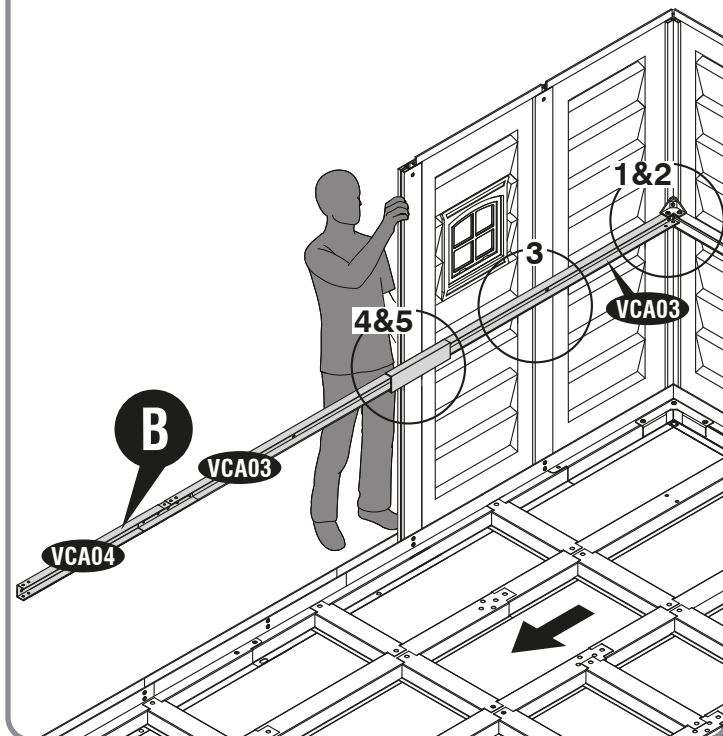

9

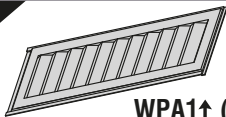

WPA1↑ (x1)



CLA3 (x1)



S1 (x3)

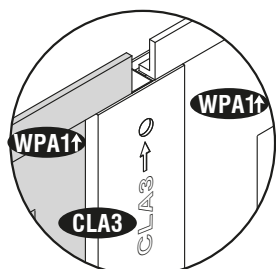
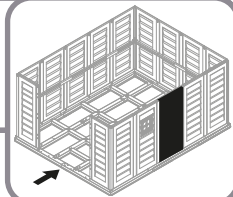

1

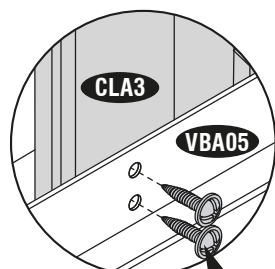

2

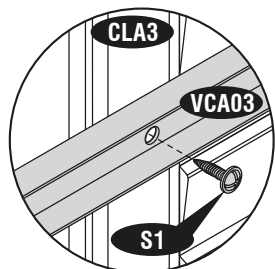

3

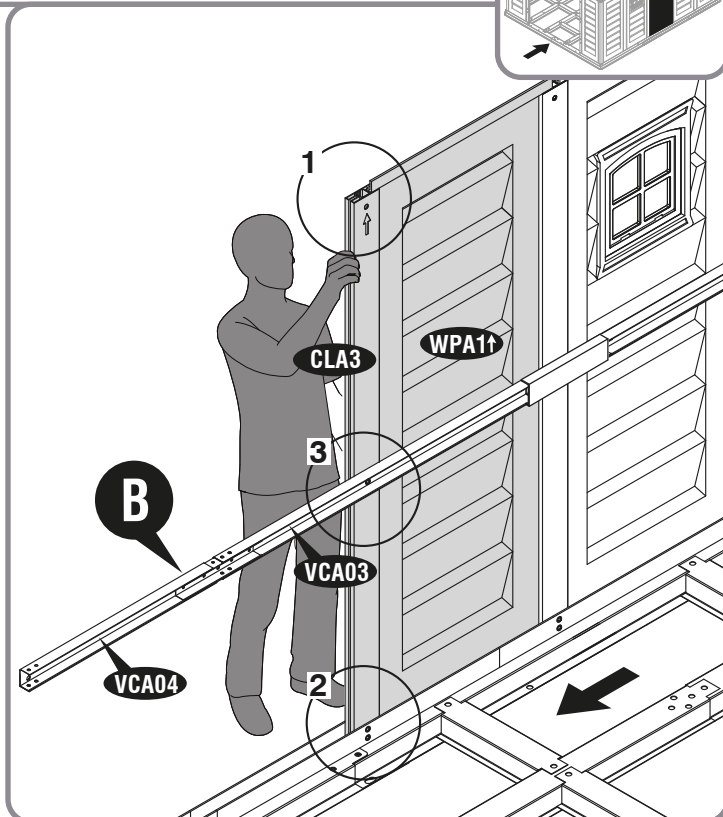

10

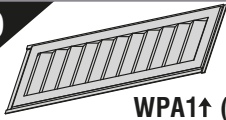

WPA1↑ (x1)

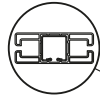

CLA3 (x1)

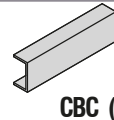

CBC (x1)

S1 (x3)

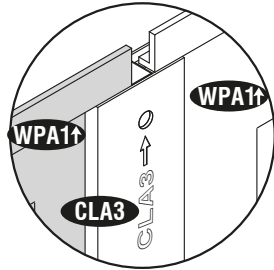
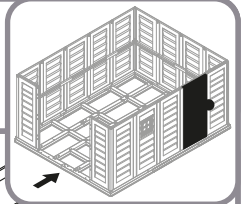

1

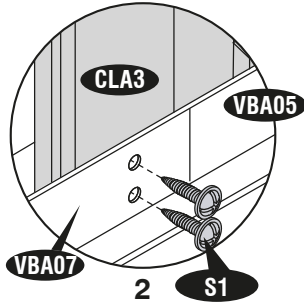

2

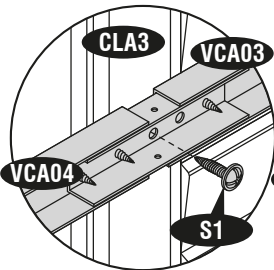

3

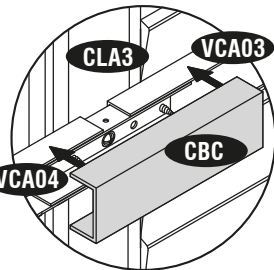

4

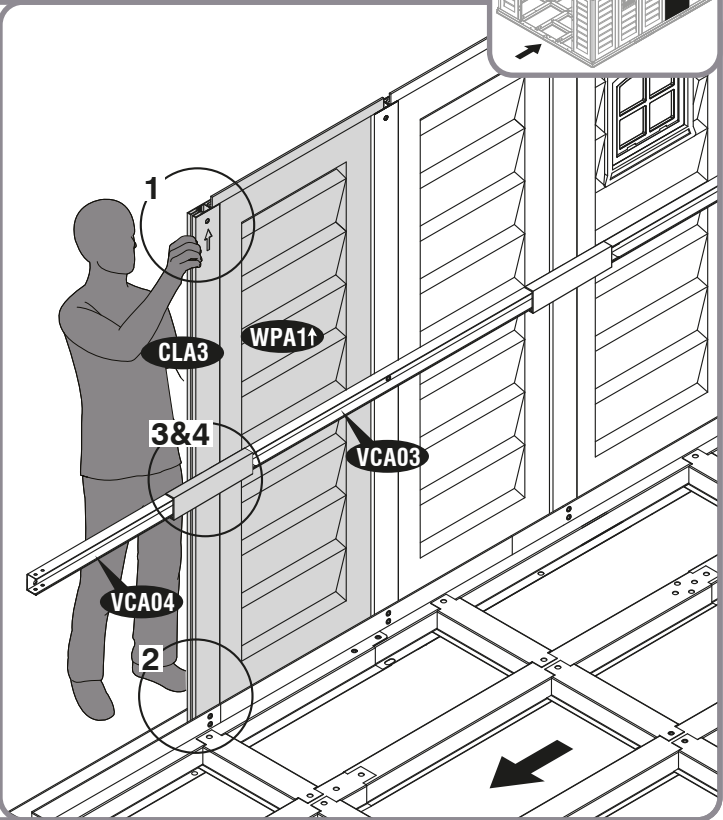

11

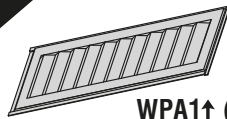

WPA1↑ (x1)

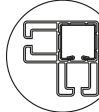

CLA2 (x1)

S1 (x2)

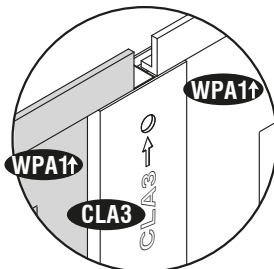
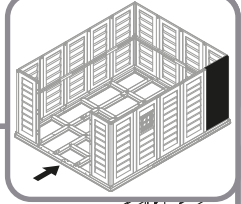

1

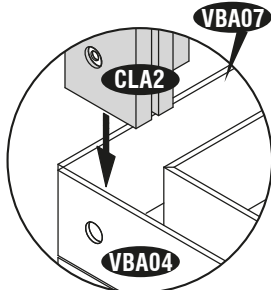

2

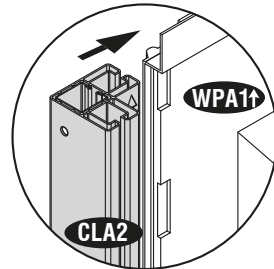

3

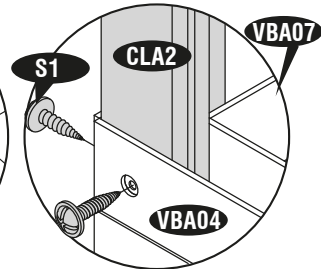

4

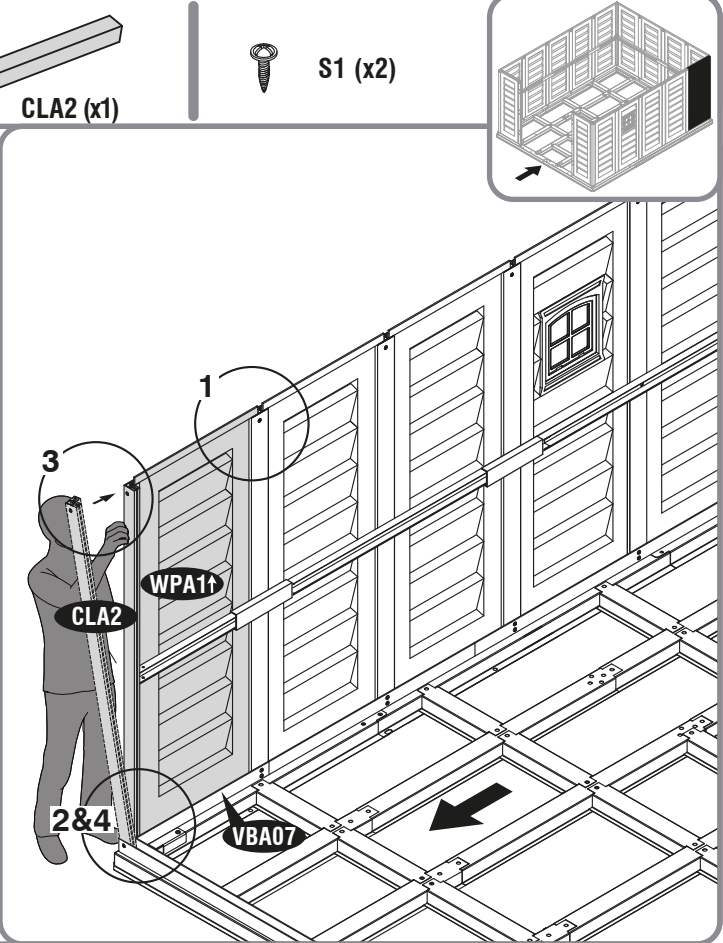



12

FCB(x1)

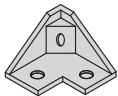

S2 (x1)



S1 (x1)

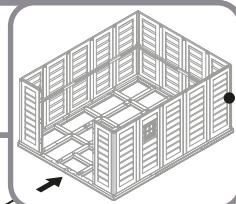

- EN Do not tighten the(S2) screw. Leave it loose.  
 FR Ne serrez pas la vis (S2). Laissez-le en vrac.  
 DE Ziehen Sie die Schraube (S2) nicht an. Lass es locker.  
 ES No apriete el tornillo (S2). Déjalo suelto.  
 PT Não aperte o parafuso (S2). Deixe solto.  
 NL Draai de (S2) schroef niet vast. Laat het los.  
 CS Neutahujte šroub (S2). Nechte to volné.  
 SK (S2) skrutku neutiahnite. Nechajte to uvoľnené.  
 SL Ne privijte vijaka (S2). Pustite ga ohlapnega.  
 HR Nemojte zategnuti vijak (S2). Ostavite ga labavim.  
 HU Ne húzza meg az (S2) csavart. Hagyja laza.  
 SV Dra inte åt (S2) skruven. Lämna det löst.  
 IT Non stringere la vite (S2). Lascialo libero.  
 PL Nie dokręcaj śruby (S2). Pozostaw to luzne.  
 RO Nu strângeți șurubul (S2). Lasă-l liber.  
 BG Не затягайте (S2) винта. Оставете го свободно.  
 TR (S2) vidasını sıkmayın. Onu serbest bırak.

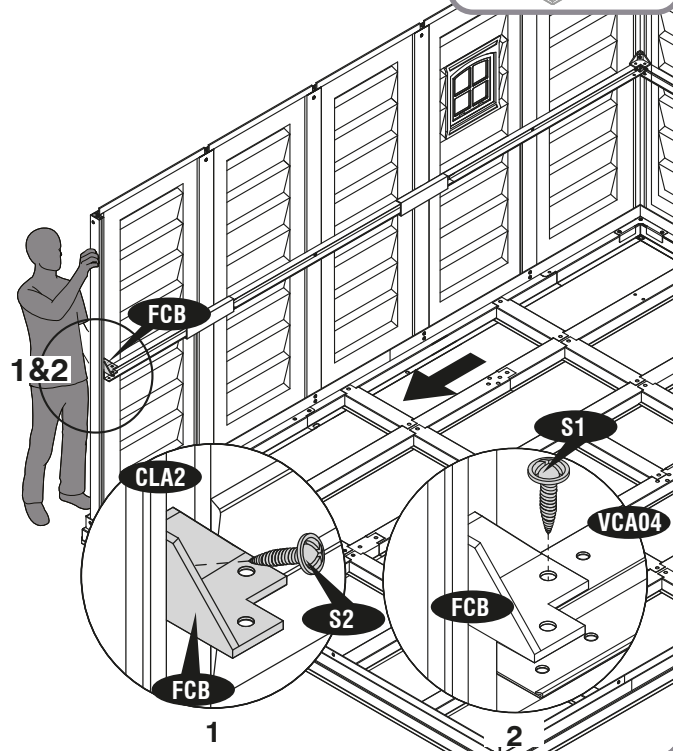

13



WPA1↑ (x1)



CLA3 (x1)



S1 (x2)

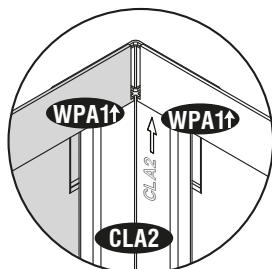
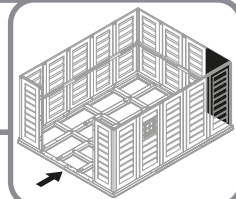

1

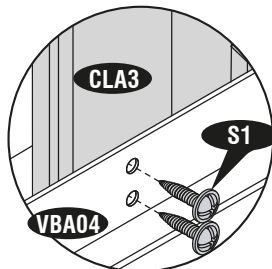

2

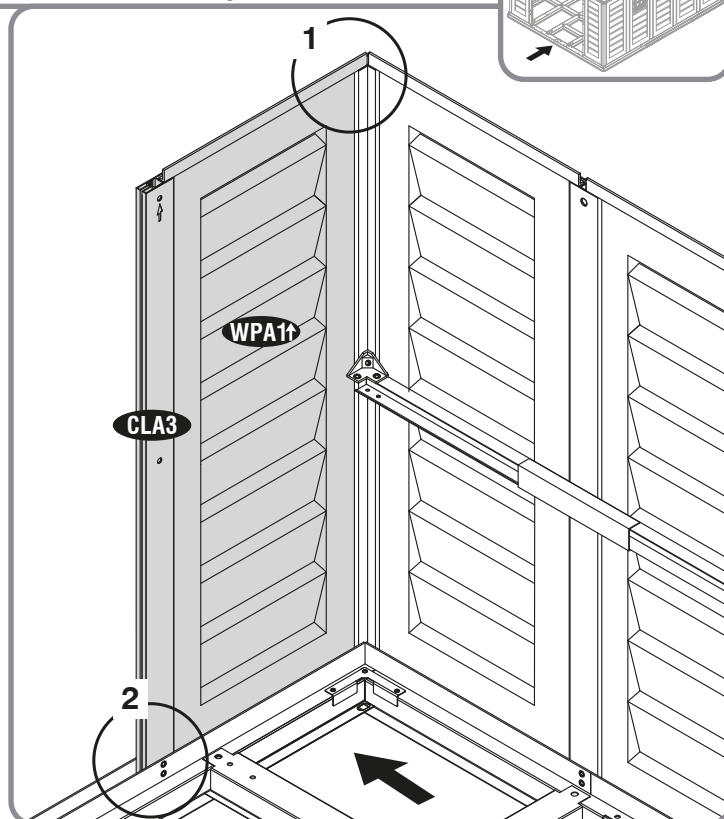

14

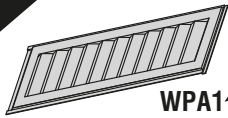

WPA1↑ (x1)



CLA3 (x1)



S1 (x2)

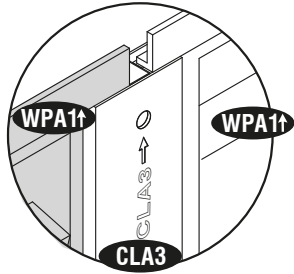
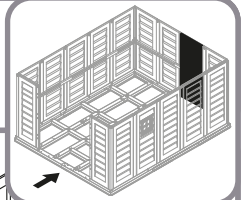

1

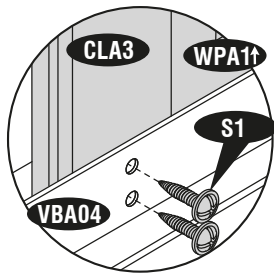

2

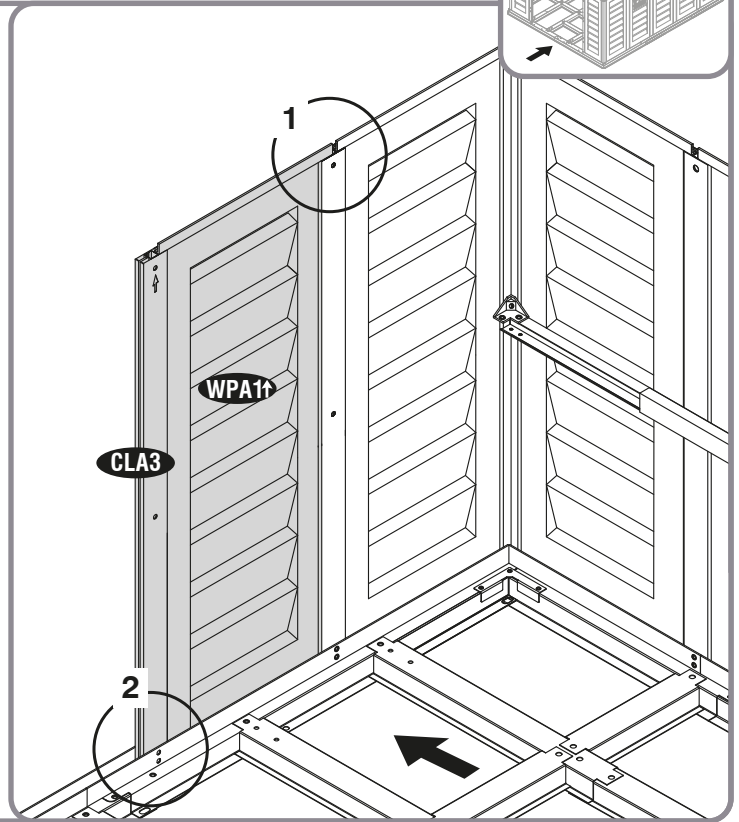

15

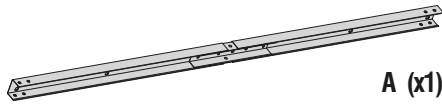

A (x1)

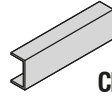

CBC (x1)



S1 (x4)

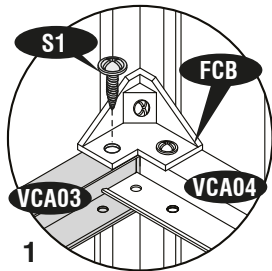
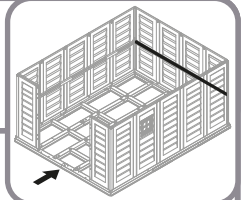

1

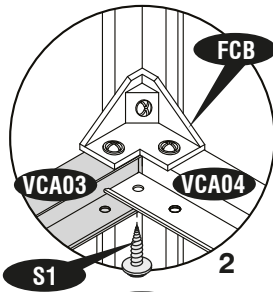

2

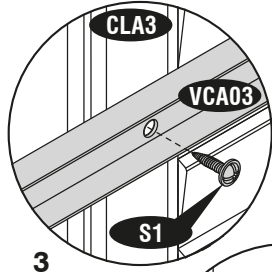

3

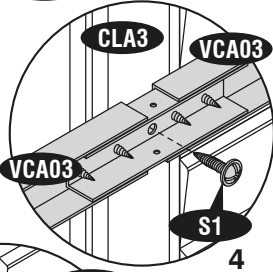

4

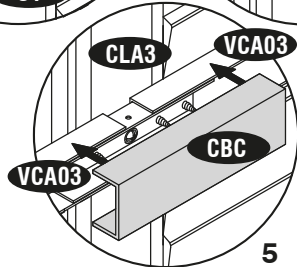

5

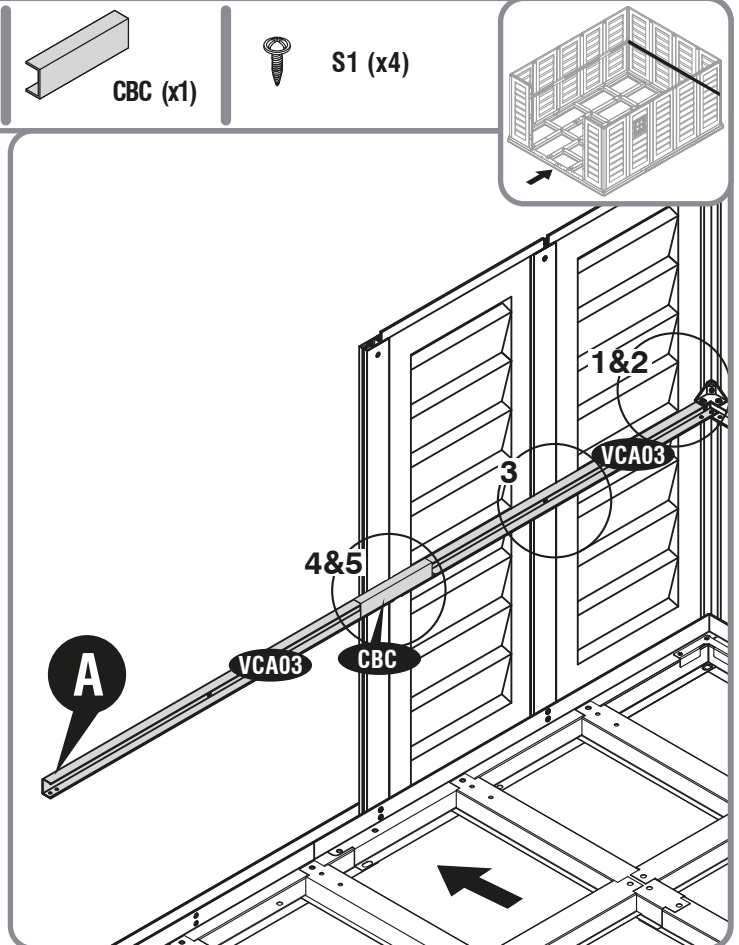



16

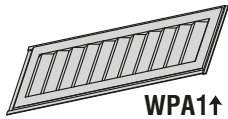

WPA1↑ (x1)

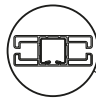

CLA3 (x1)



S1 (x3)

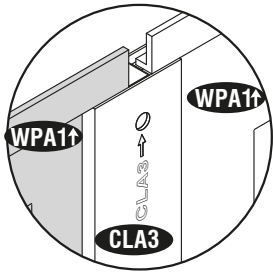
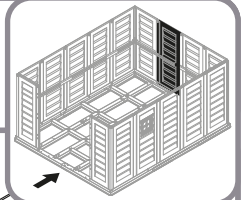

1

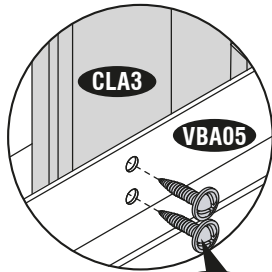

2

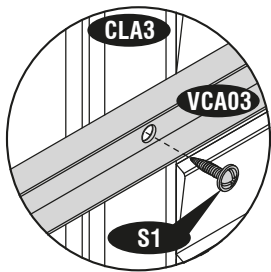

3

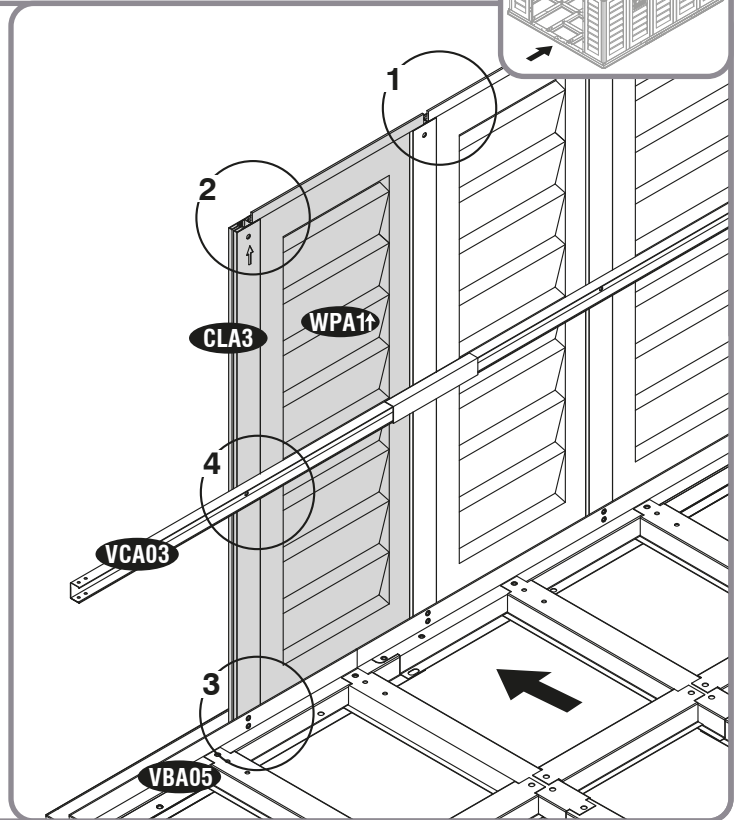

17

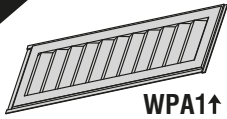

WPA1↑ (x1)



CLA2 (x1)



S1 (x2)

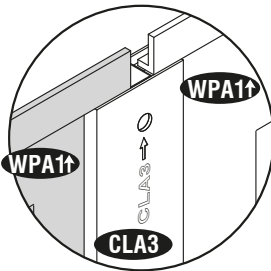
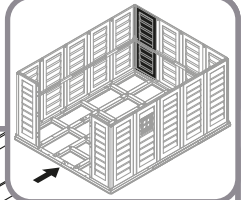

1

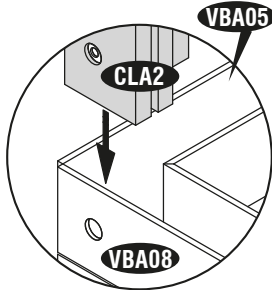

2

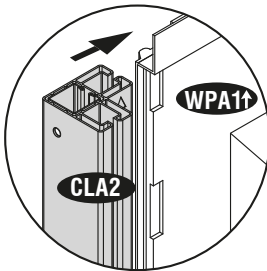

3

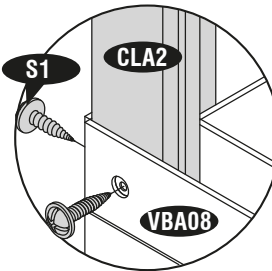

4

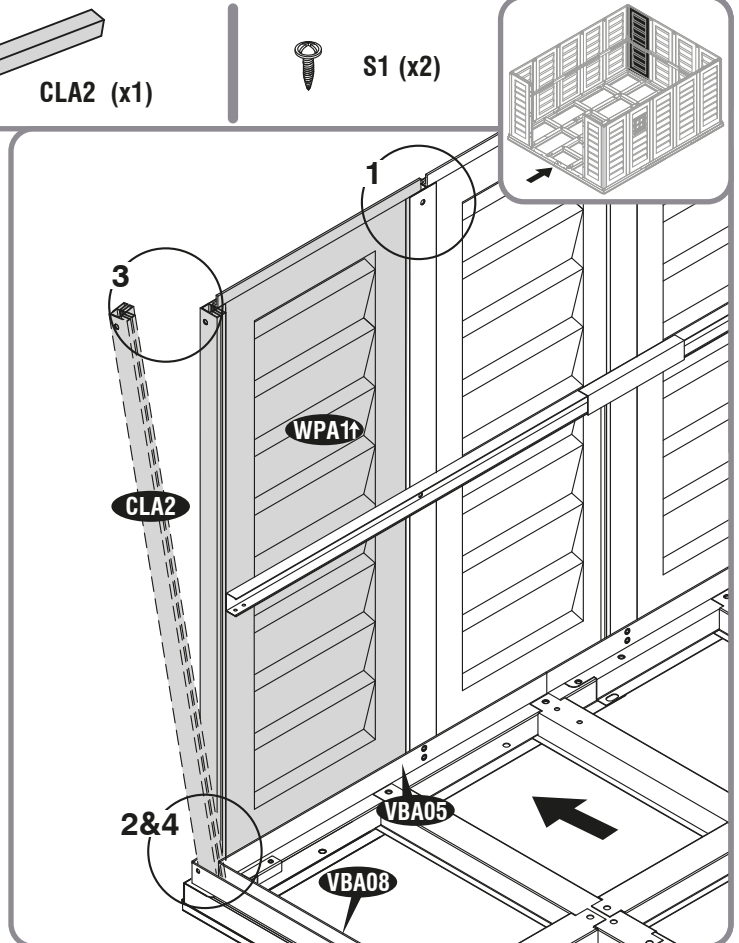

18

FCB(x1)

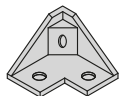

S2 (x1)



S1 (x1)

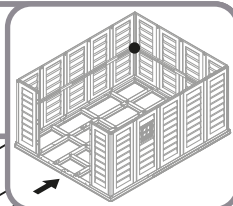

- EN Do not tighten the(S2) screw. Leave it loose.  
 FR Ne serrez pas la vis (S2). Laissez-le en vrac.  
 DE Ziehen Sie die Schraube (S2) nicht an. Lass es locker.  
 ES No apriete el tornillo (S2). Déjalo suelto.  
 PT Não aperte o parafuso (S2). Deixe solto.  
 NL Draai de (S2) schroef niet vast. Laat het los.  
 CS Neutahujte šroub (S2). Nechte to volné.  
 SK (S2) skrutku neutiahnite. Nechajte to uvoľnené.  
 SL Ne privijte vijaka (S2). Pustite ga ohlapnega.  
 HR Nemojte zategnuti vijak (S2). Ostavite ga labavim.  
 HU Ne húzza meg az (S2) csavart. Hagyja laza.  
 SV Dra inte åt (S2) skruven. Lämna det löst.  
 IT Non stringere la vite (S2). Lascialo libero.  
 PL Nie dokręcaj śruby (S2). Pozostaw to luźne.  
 RO Nu strângeți șurubul (S2). Lasă-l liber.  
 BG Не затягайте (S2) винта. Оставете го свободно.  
 TR (S2) vidasını sıkmayın. Onu serbest bırak.

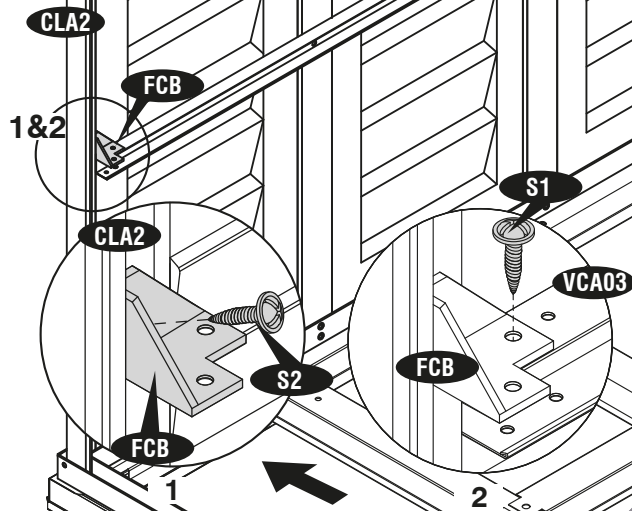

19

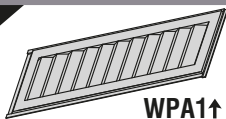

WPA1↑ (x1)

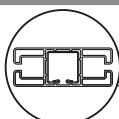

CLA3 (x1)



S1 (x2)

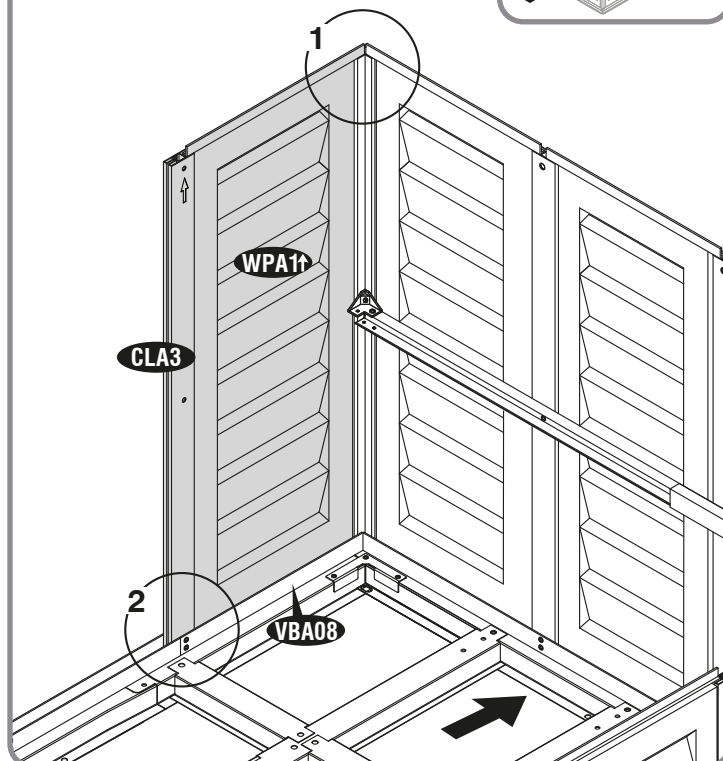
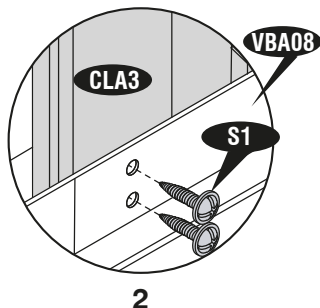
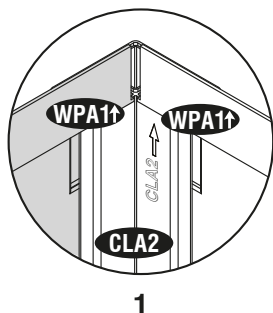
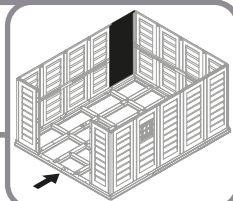

20

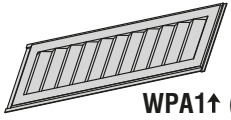

WPA1↑ (x1)

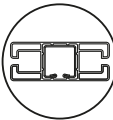

CLA3 (x1)



S1 (x2)

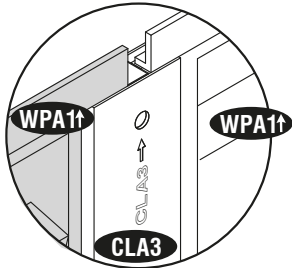
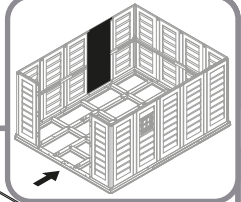

1

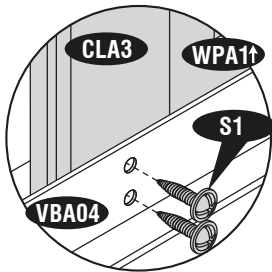

2

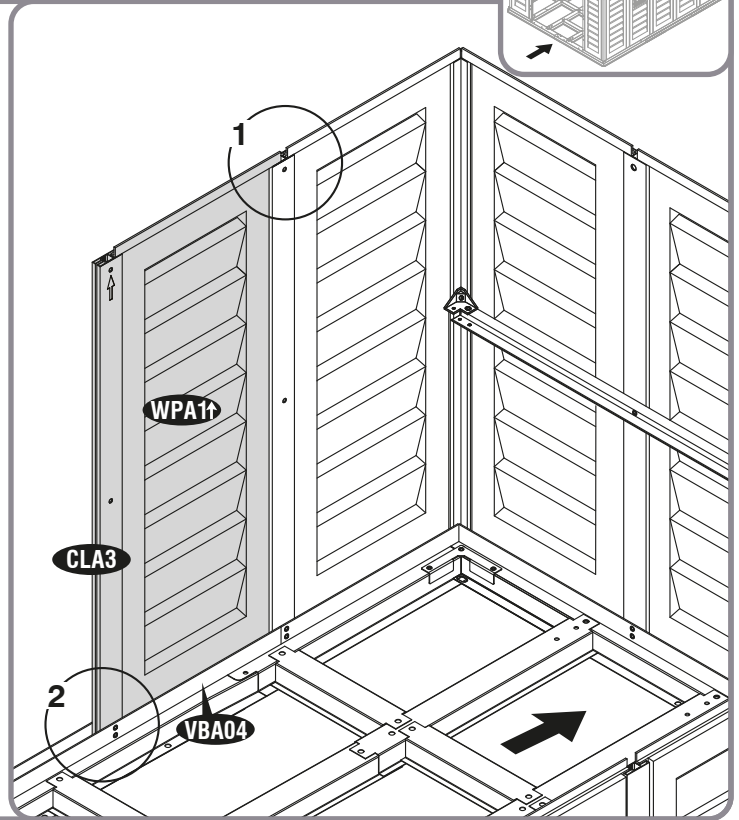

21

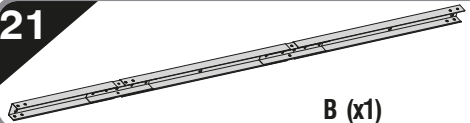

B (x1)

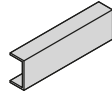

CBC (x1)



S1 (x4)

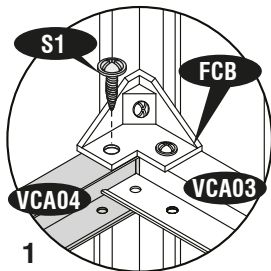
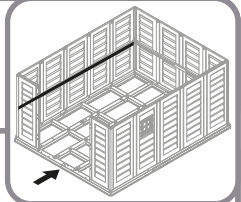

1

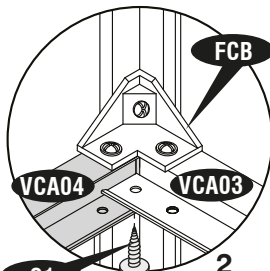

2

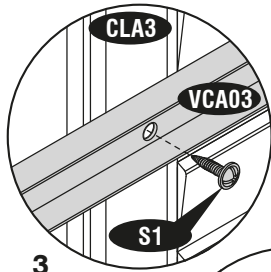

3

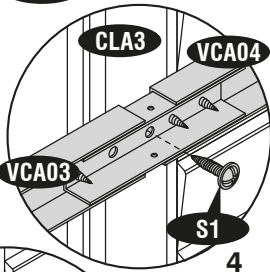

4

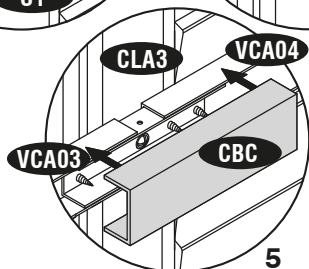

5

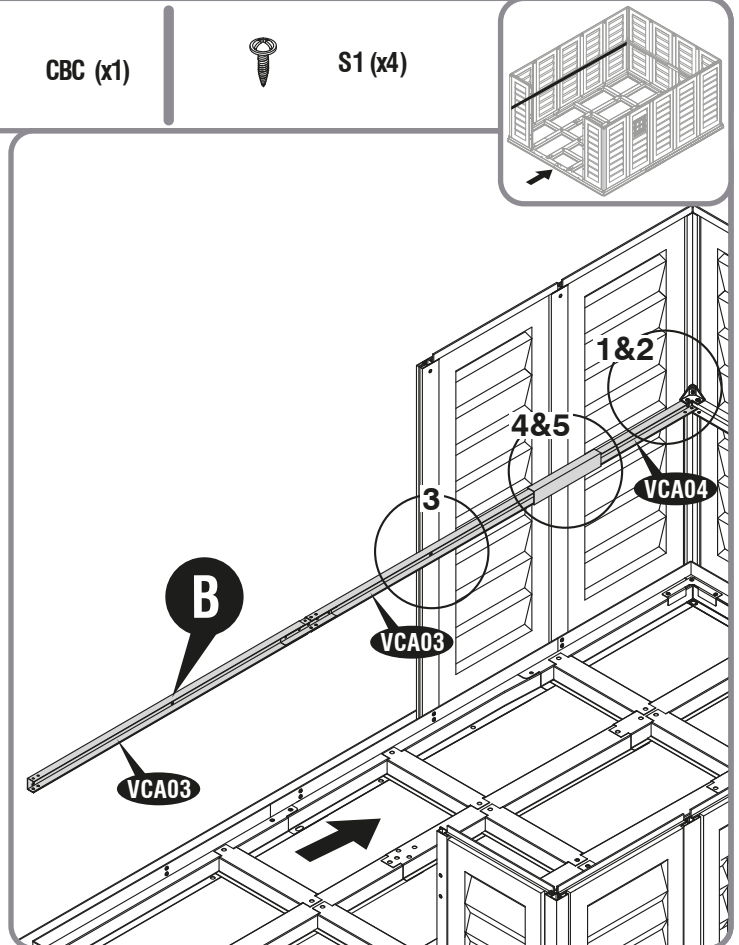

22

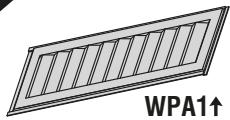

WPA1↑ (x1)

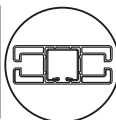

CLA3 (x1)

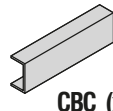

CBC (x1)



S1 (x3)

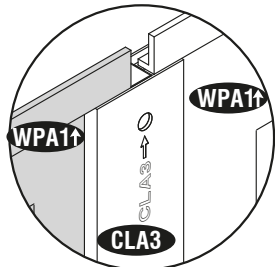
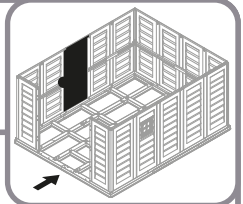

1

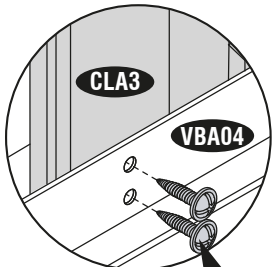

2

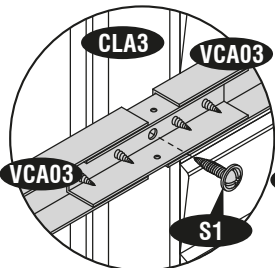

3

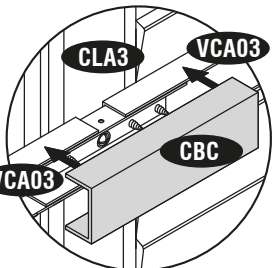

4

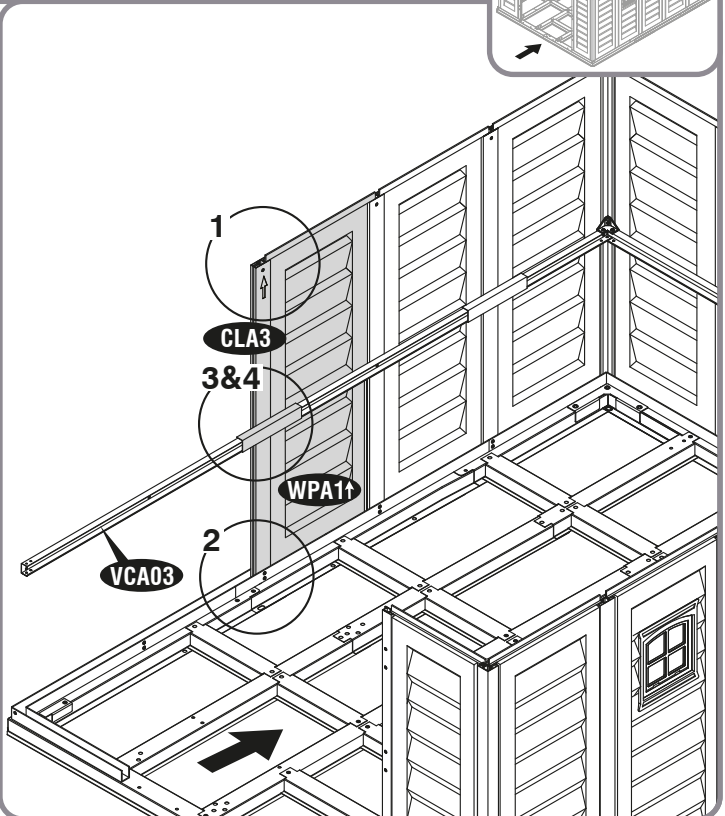

23

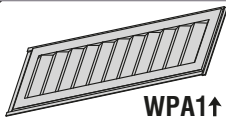

WPA1↑ (x1)

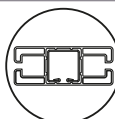

CLA3 (x1)



S1 (x3)

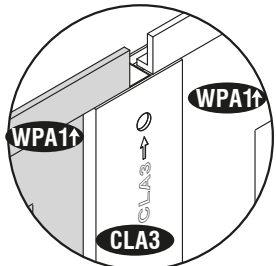
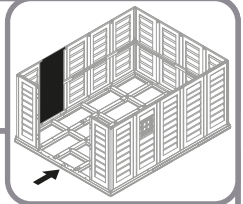

1

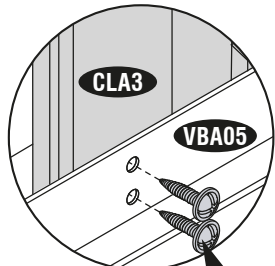

2

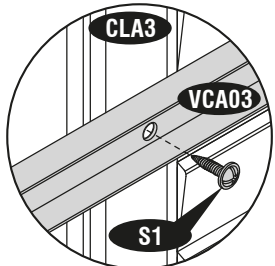

3

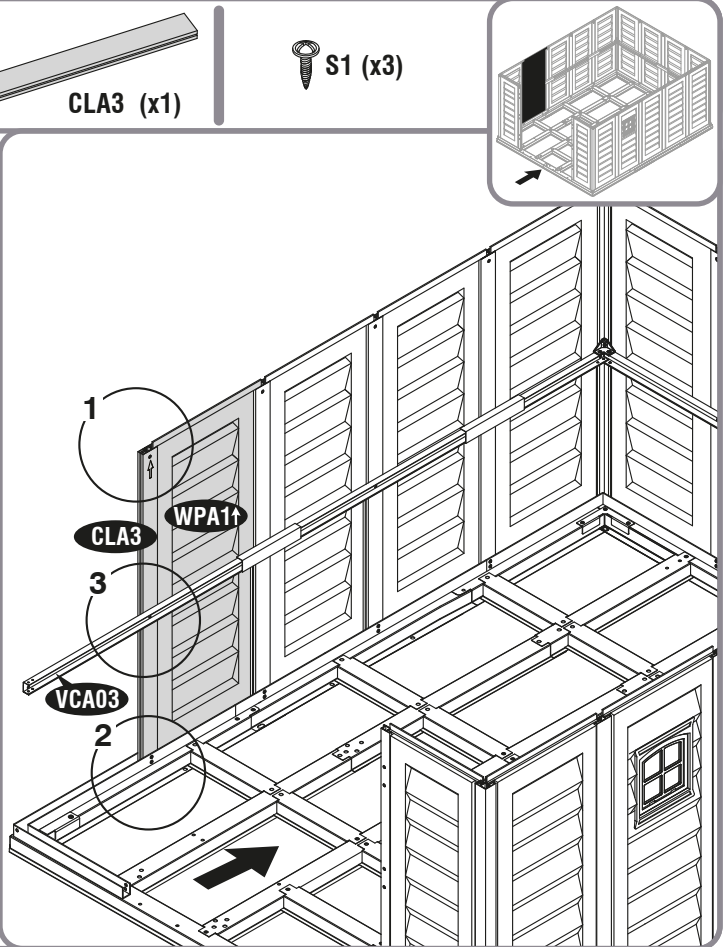

45



24

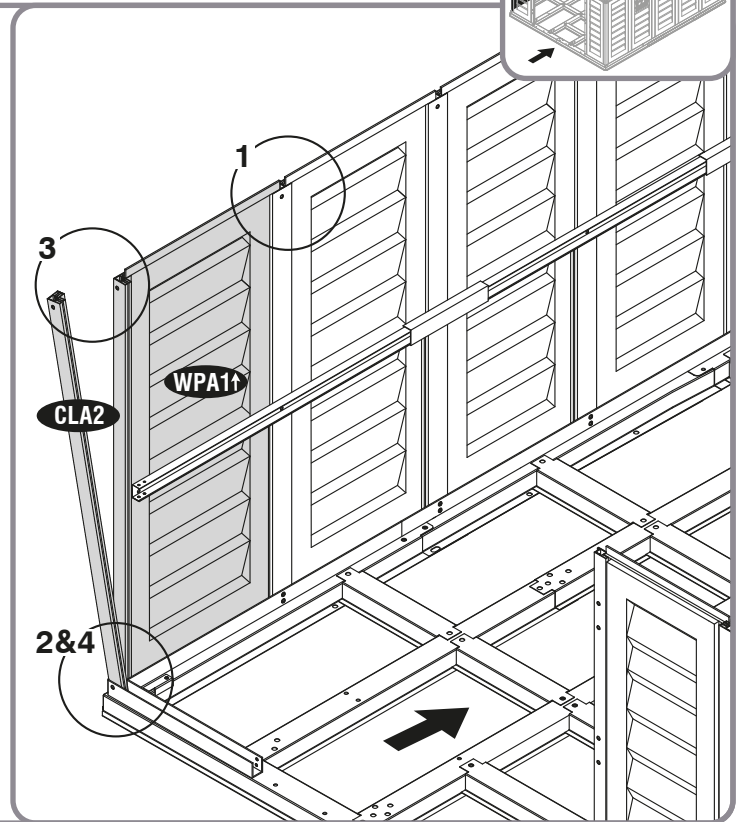
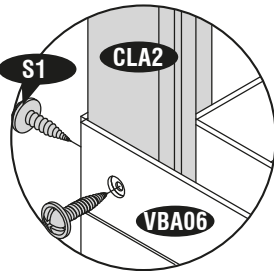
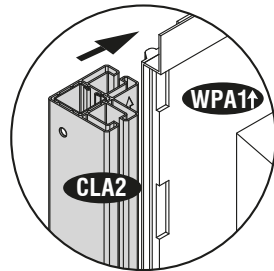
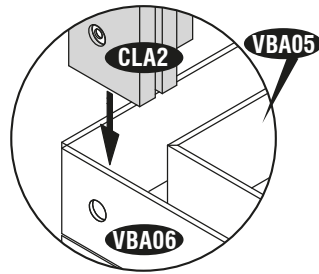
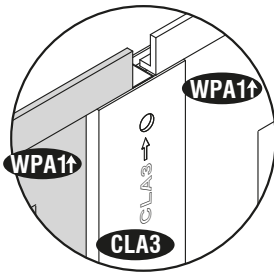
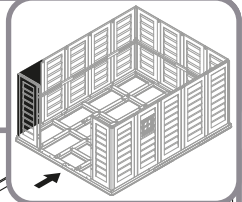
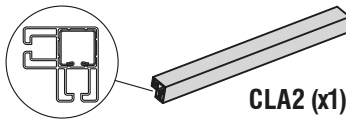
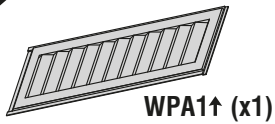

25

FCB(x1)

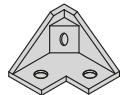

S2 (x1)



S1 (x1)

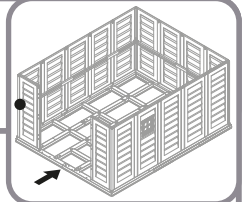

- EN Do not tighten the(S2) screw. Leave it loose.  
 FR Ne serrez pas la vis (S2). Laissez-le en vrac.  
 DE Ziehen Sie die Schraube (S2) nicht an. Lass es locker.  
 ES No apriete el tornillo (S2). Déjalo suelto.  
 PT Não aperte o parafuso (S2). Deixe solto.  
 NL Draai de (S2) schroef niet vast. Laat het los.  
 CS Neutahujte šroub (S2). Nechte to volné.  
 SK (S2) skrutku neutiahnite. Nechajte to uvoľnené.  
 SL Ne privijte vijaka (S2). Pustite ga ohlapnega.  
 HR Nemojte zategnuti vijak (S2). Ostavite ga labavim.  
 HU Ne húzza meg az (S2) csavart. Hagyja laza.  
 SV Dra inte åt (S2) skruven. Lämna det löst.  
 IT Non stringere la vite (S2). Lascialo libero.  
 PL Nie dokręcaj śruby (S2). Pozostaw to luźne.  
 RO Nu strângeți șurubul (S2). Lasă-l liber.  
 BG Не затягайте (S2) винта. Оставете го свободно.  
 TR (S2) vidasını sıkmayın. Onu serbest bırak.

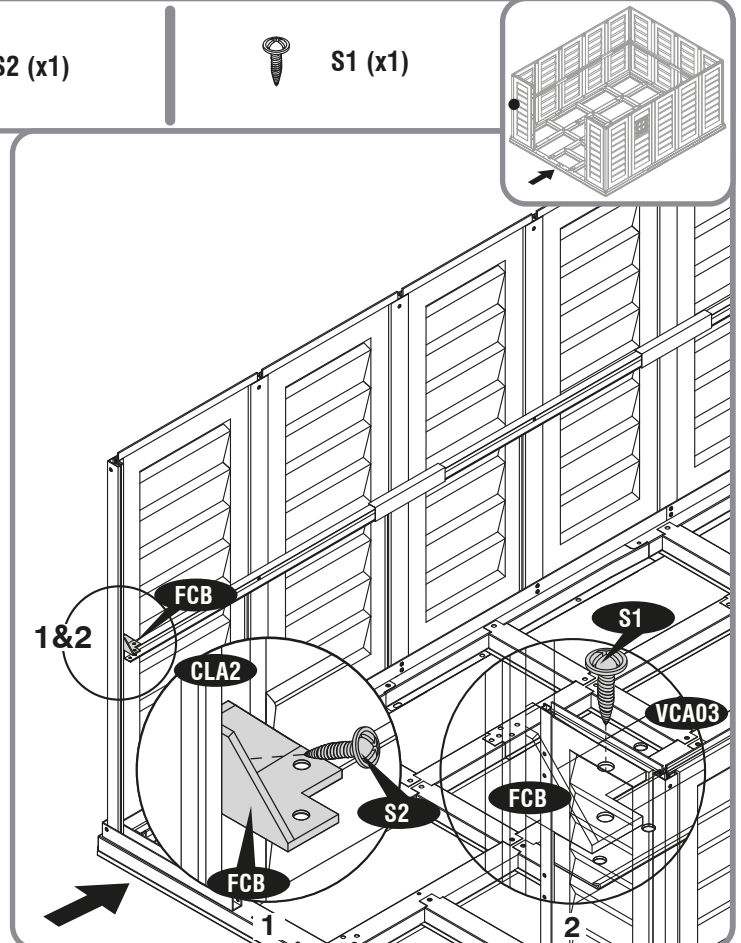

46



26



WPA1↑ (x1)

CLA4 (x1)

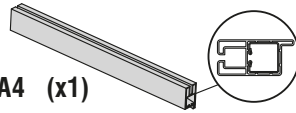

S1 (x2)

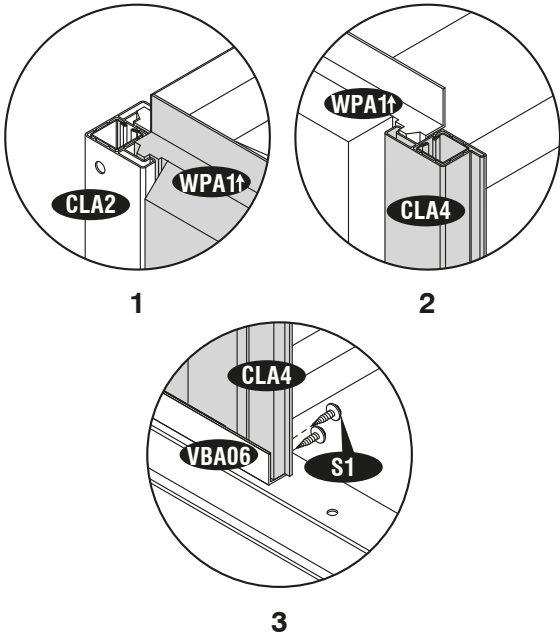
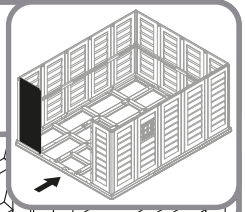

1

2

3

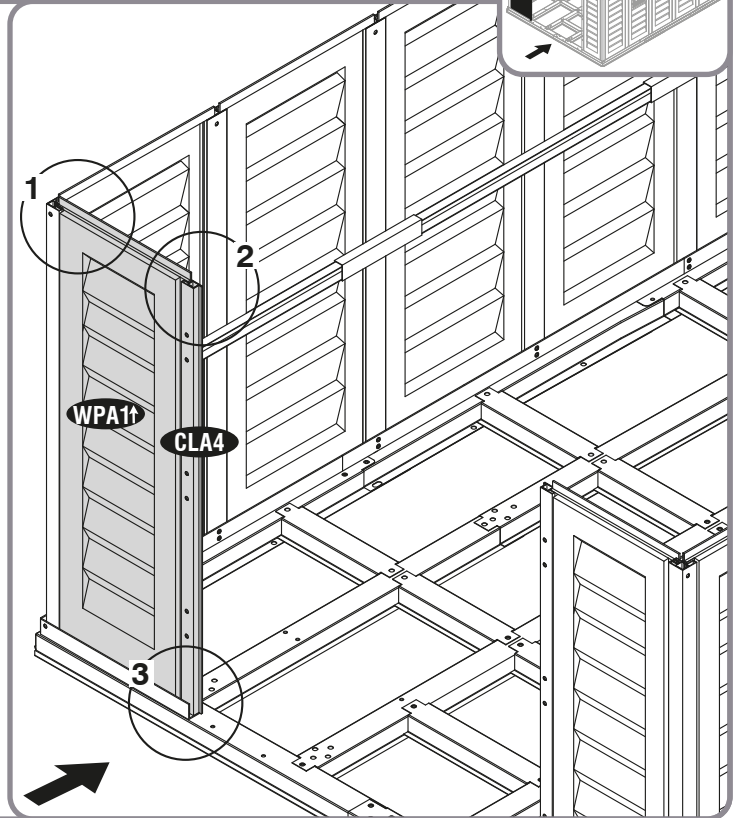

27

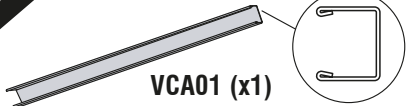

VCA01 (x1)

S1 (x3)



EPS (x1)

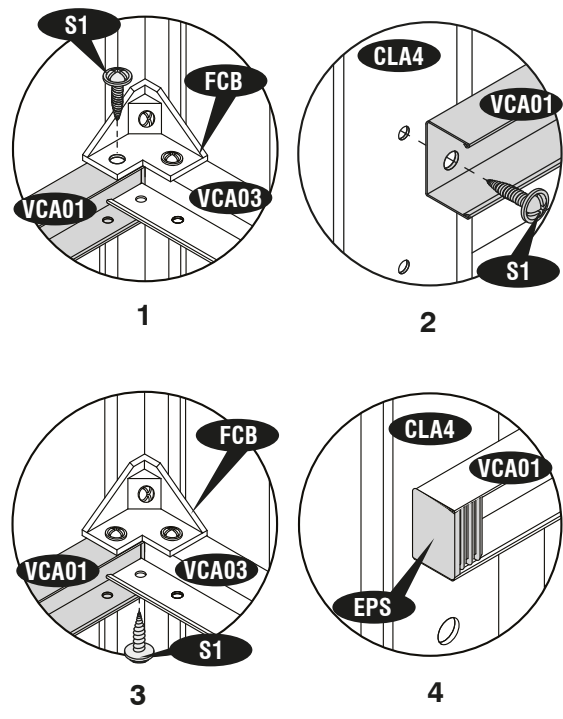
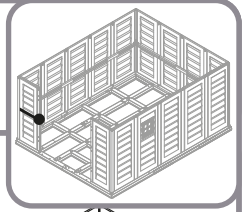

1

2

3

4

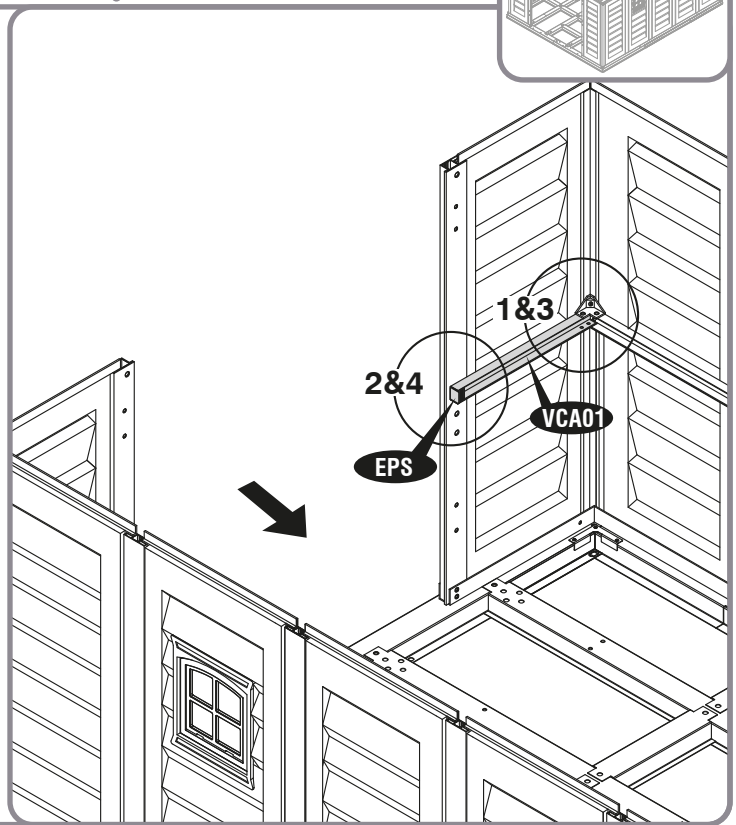

47

- EN After completing the center band assembly, fully tighten the four center band fittings (FCB) to the corner column (CLA2).
- FR Après avoir terminé l'assemblage de la bande centrale, bien serrer les quatre raccords de la bande centrale (FCB) à la colonne d'angle (CLA2).
- DE Ziehen Sie nach Abschluss der Montage des Mittelbandes die vier Mittelbandverschraubungen (FCB) vollständig an der Eckstütze (CLA2) fest.
- ES Después de completar el conjunto de la banda central, apriete completamente los cuatro accesorios de la banda central (FCB) a la columna de la esquina (CLA2).
- PT Depois de concluir o conjunto da banda central, aperte totalmente as quatro conexões de faixa central (FCB) na coluna de canto (CLA2).
- NL Nadat u de middenbandassemblage hebt voltooid, draait u de vier middenbandfittingen (FCB) volledig vast aan de hoekkolom (CLA2).
- CS Po dokončení sestavy středového pásu úplně utáhněte čtyři kování středového pásu (FCB) na rohový sloup (CLA2).
- SK Po dokončení montáže stredového pásu úplne dotiahnite štyri kovania stredového pásu (FCB) k rohovému stĺpu (CLA2).
- SL Po končanem sestavljanju sredinskega traku popolnoma privijte štiri priključke sredinskega traku (FCB) v vogalni stolpec (CLA2).
- HR Nakon završetka sastavljanja središnje trake, potpuno zategnite četiri središnja pojasna priključka (FCB) u kutni stupac (CLA2).
- HU Miután befejezte a középsáv szerelvényt, húzza meg teljesen a négy középsáv szerelvényt (FCB) a sarokoszlophoz (CLA2).
- SV När du har avslutat mittbandsenheten, dra åt de fyra mittbandsbeslagen (FCB) helt till hörnspelaren (CLA2).
- IT Dopo aver completato il montaggio della fascia centrale, serrare completamente i quattro raccordi della fascia centrale (FCB) sulla colonna angolare (CLA2).
- PL Po zakończeniu montażu opaski środkowej całkowicie dokręć cztery środkowe łączniki taśmowe (FCB) do kolumny narożnej (CLA2).
- RO După finalizarea ansamblului benzii centrale, strângeți complet cele patru fittinguri de centru (FCB) la coloana colțară (CLA2).
- BG След завършване на сглобяването на централната лента, изцяло затегнете четирите централни лентови фитинги (FCB) към ъгловата колона (CLA2).
- TR Orta bant grubunu tamamladıktan sonra, dört orta bant bağlantısını (FCB) köşe kolonuna (CLA2) tamamen sıkın.

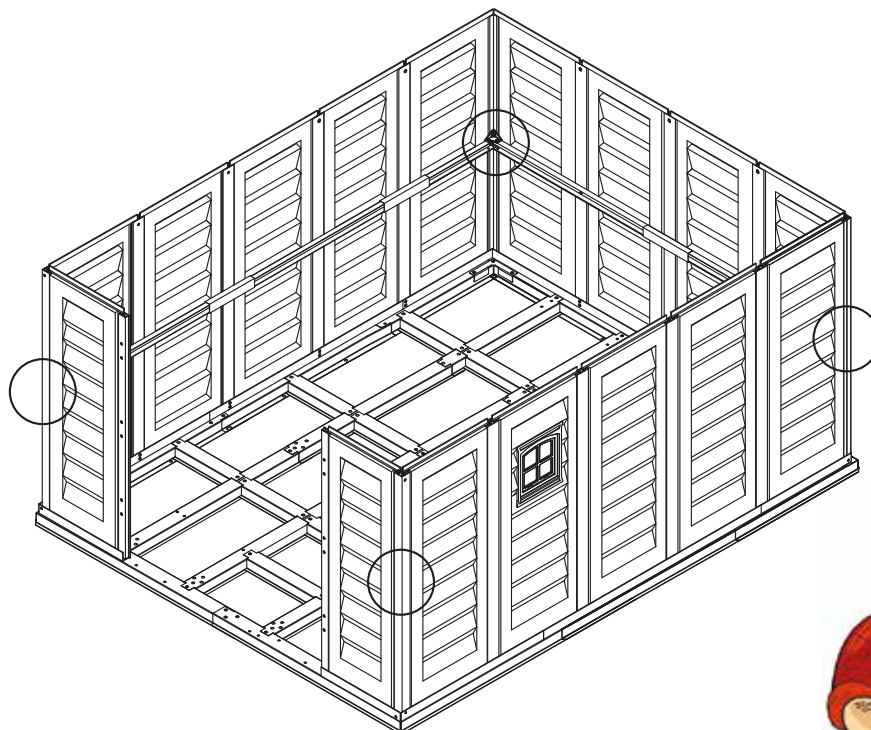



- 5**
- EN Roof Structures
  - CS Střešní konstrukce
  - IT Structure di tetto
  - FR Structure Du Toit
  - SK Strešné konštrukcie
  - PL Struktura dachu
  - DE Dachkonstruktionen
  - SL Strešne Konstrukcije
  - RO Structuri de acoperiș
  - ES Estructuras de techo
  - HR Krovne konstrukcije
  - BG Покривни конструкции
  - PT Estrutura do Telhado
  - HU Tetőszerkezetek
  - TR Çati yapıları
  - NL Dakconstructies
  - SV Takstrukturer

- EN Parts needed
- CS Potřebné součásti
- IT Parti occorrenti
- FR Pièces nécessaires
- SK Potrebne časti
- PL Niezbędne elementy
- DE Benötigte Teile
- SL Dele, ki jih boste potrebovali
- RO Elementele componente necesare
- ES Piezas necesitadas
- HR Dijelovi potreban
- BG Необходими части
- PT Peças Necessárias
- HU Szükséges részek
- TR Gerekli parçalar
- NL Onderdelen nodig
- SV Delar som behövs

C	1	VRA15	2	FCC	4
D	1	VRA53	8	FMC	11
E	2	VRA54	10	S1	90
F	1	VRA19	2	S2	4
G	2	FDCR	1	S7	78
VRA14	2	FDCL	1		



**1**

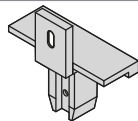

**FMC (x11)**



**S1 (x11)**

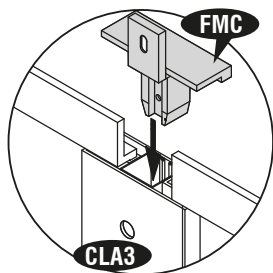
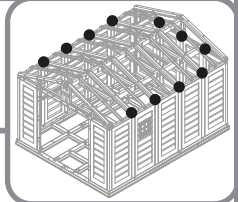

**1**

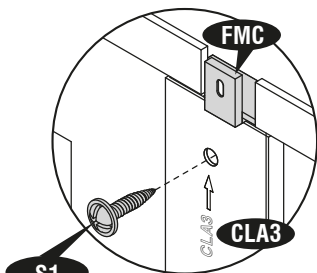

**2**

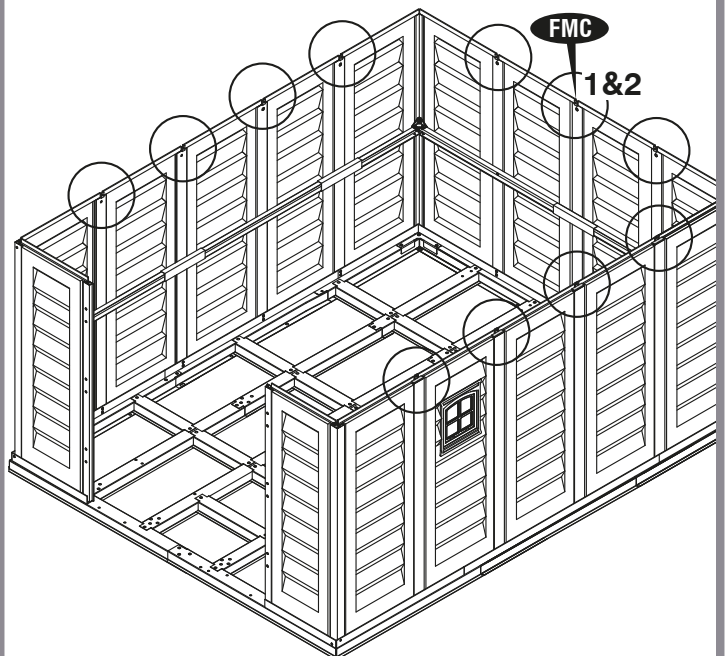

2

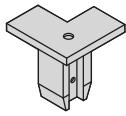

FCC (x4)



S1 (x4)

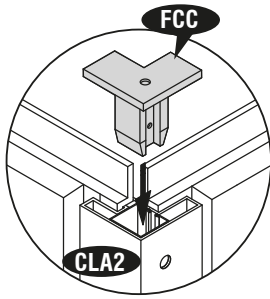
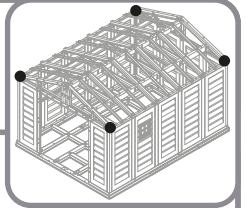

1

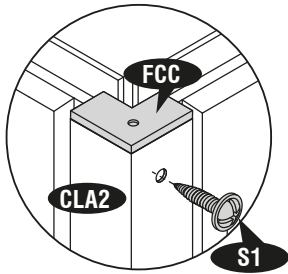

2

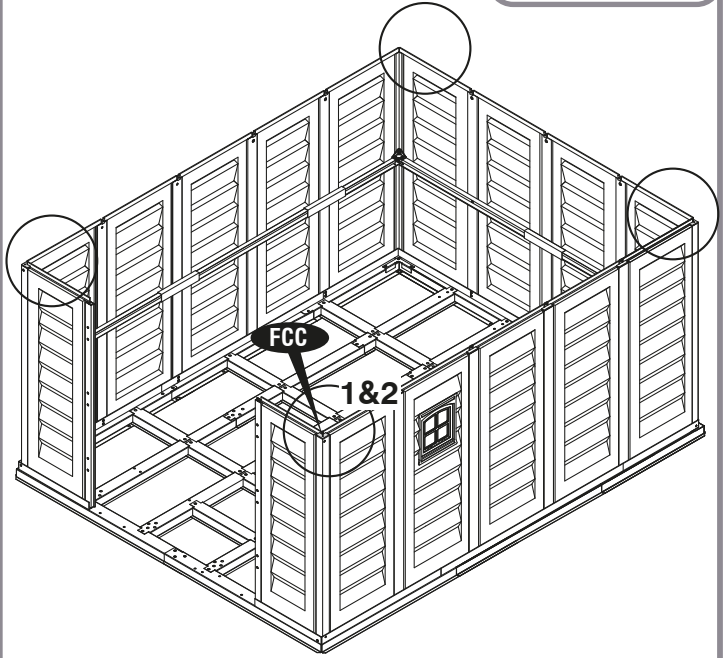

3

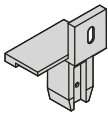

FDCR (x1)

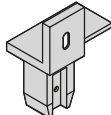

FDCL (x1)



S1 (x2)

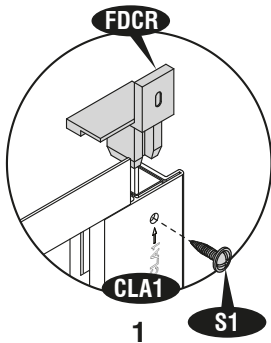
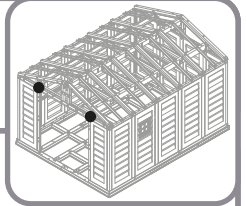

1

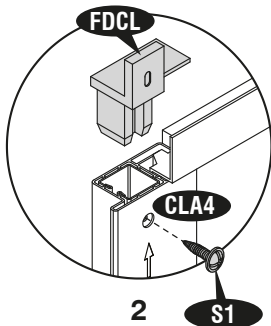

2

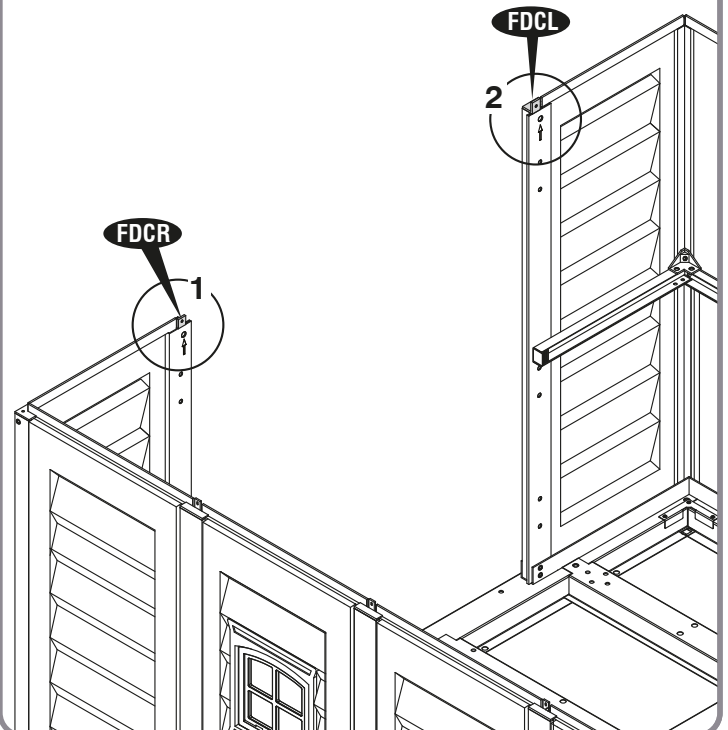



EN Roof Structure Assembly

FR Assemblage De La Structure Du Toit

DE Dachkonstruktion Montage

ES Estructura de Asamlea de techo

PT Armação da Estrutura do Telhado

NL Dakconstructie montage kit

CS Montážní souprava střešní konstrukce

SK Montáž konštrukcie strechy

SL Sestavni Deli Strešne Konstrukcije

HR Sklop krovne konstrukcije

HU Tetőszerkezet szerelvény

SV Takkonstruktion

IT Assemblea tetto della struttura

PL ontaż konstrukcji dachu

RO Coinneamh Structar Deil

BG Покривна конструкция събрание

TR Çati Yapısı Meclisi

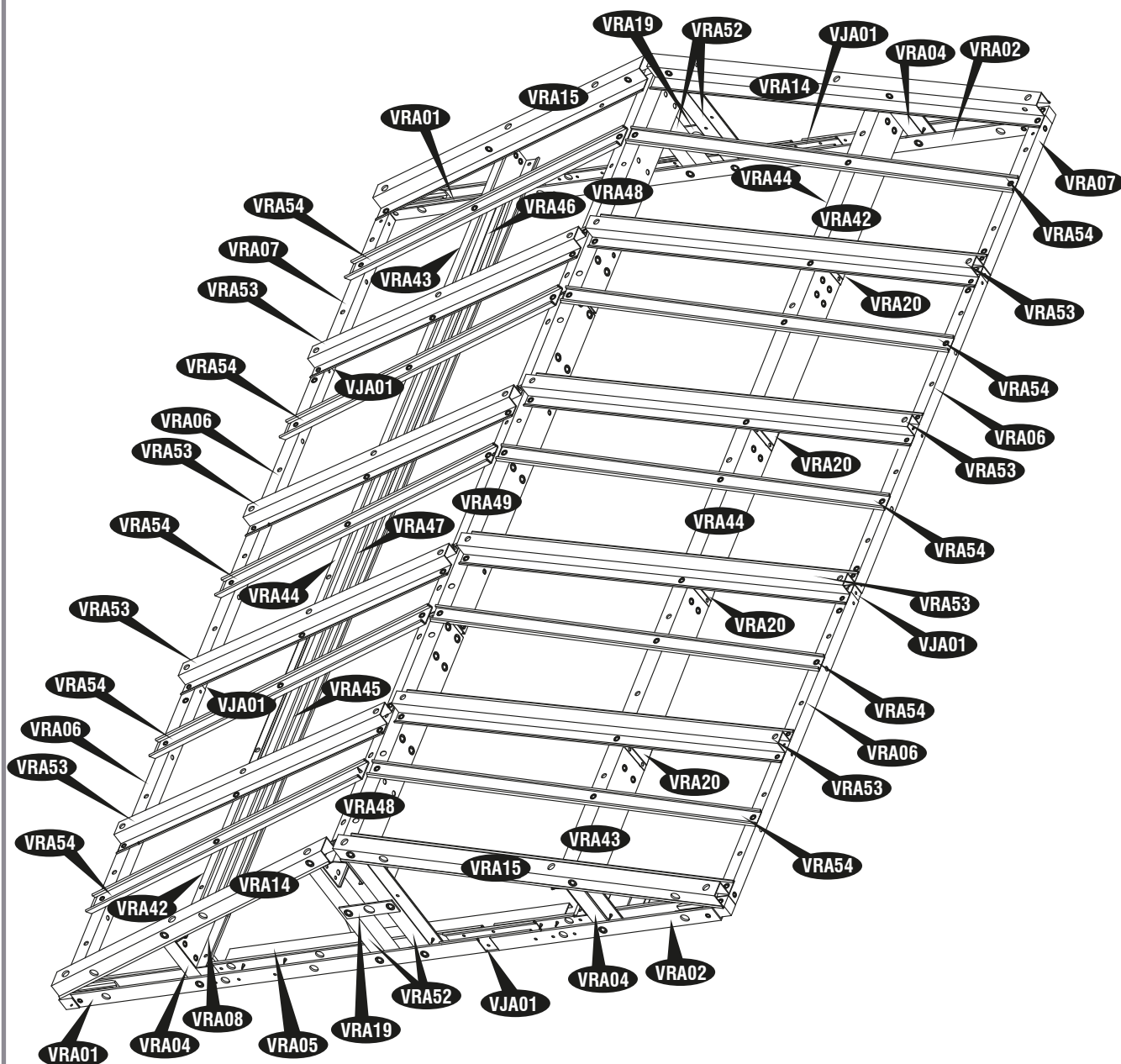

4

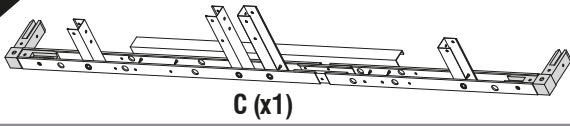

S1 (x2)



S2 (x2)

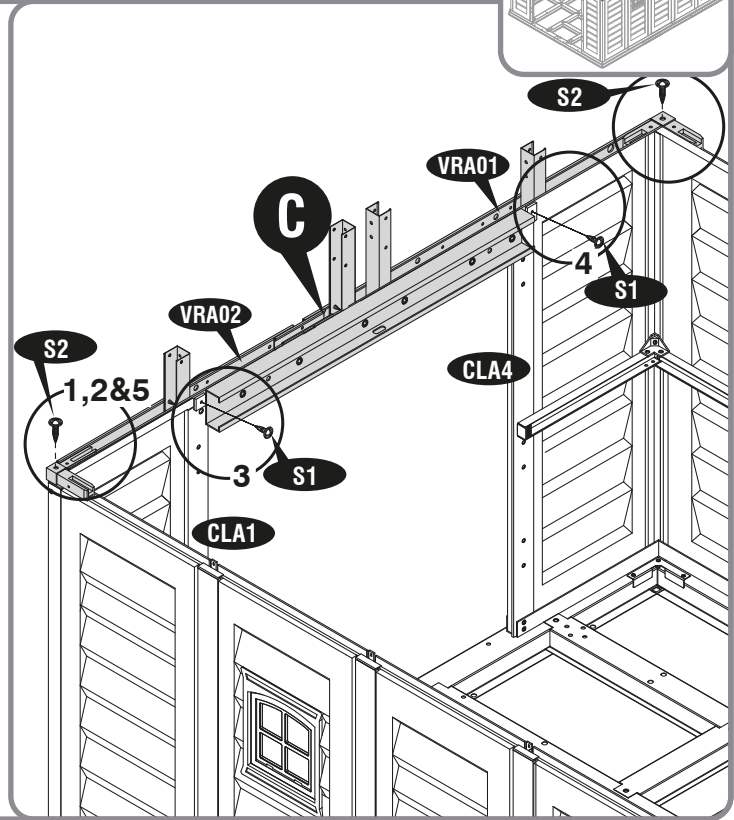
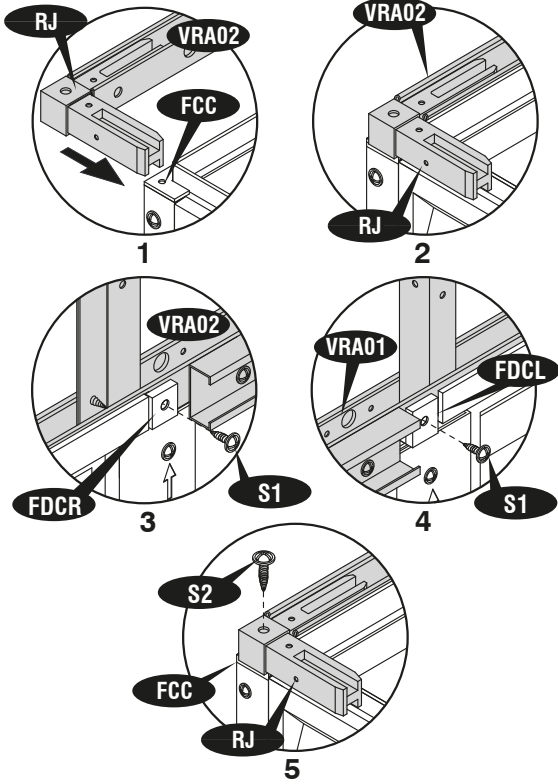
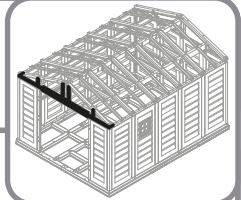

5

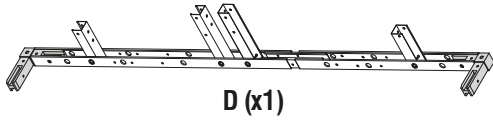

S1 (x3)



S2 (x2)

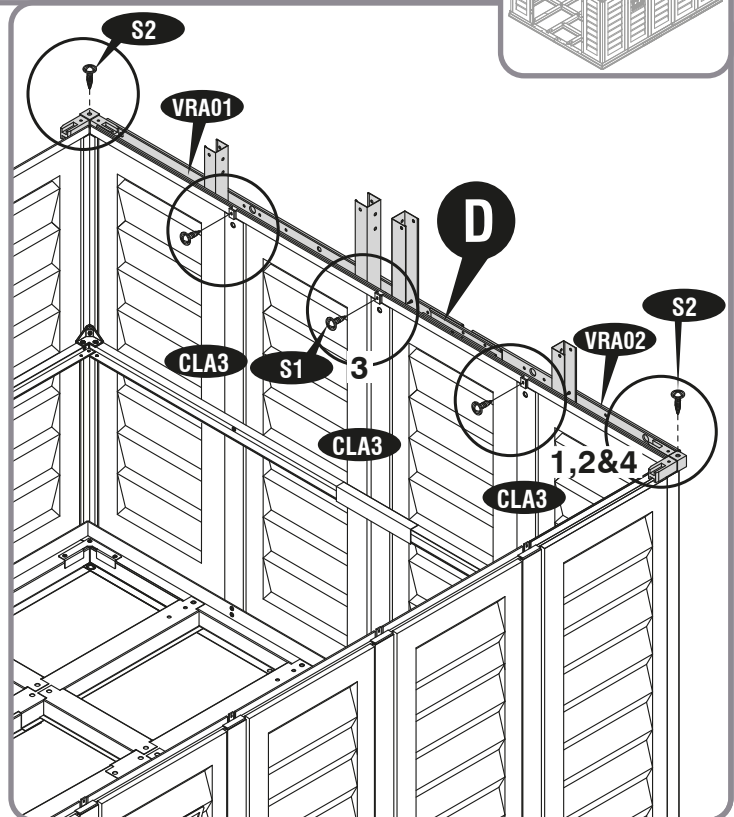
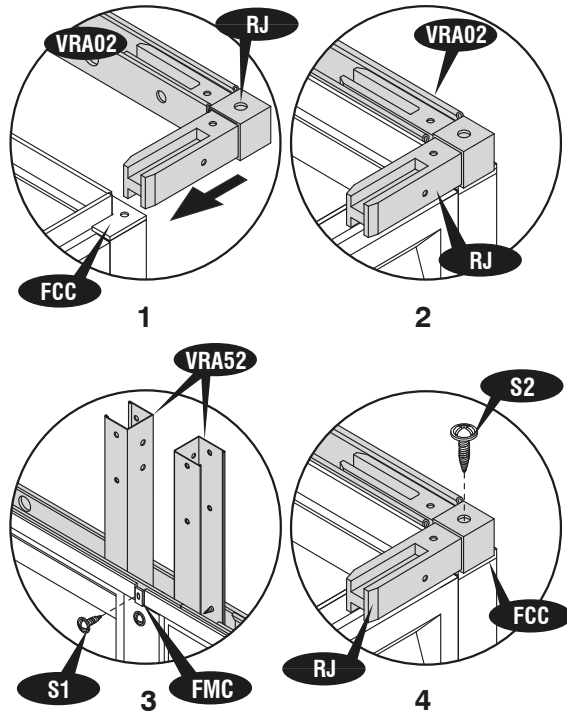
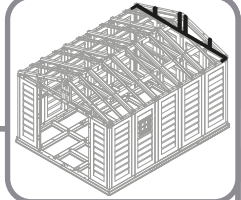



6

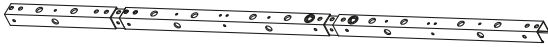

E (x2)



S1 (x4)

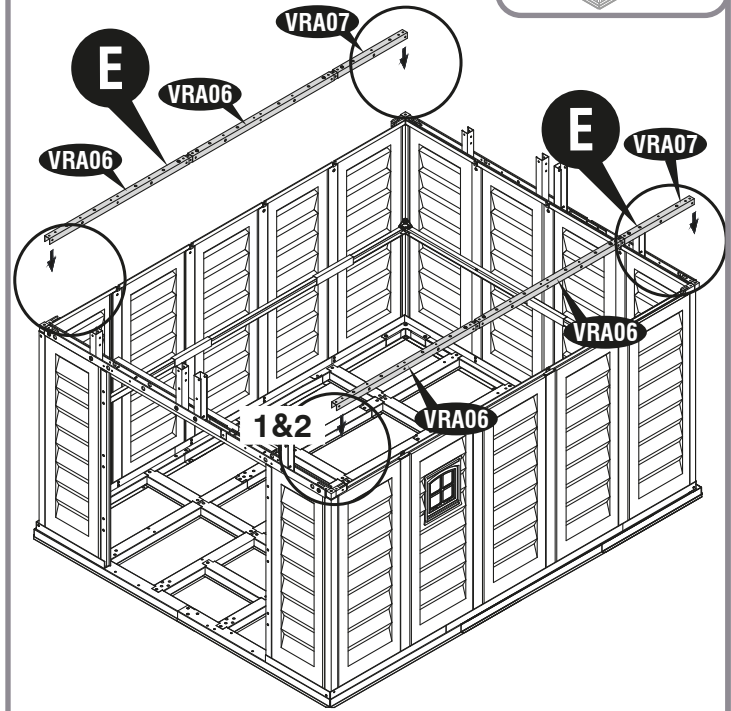
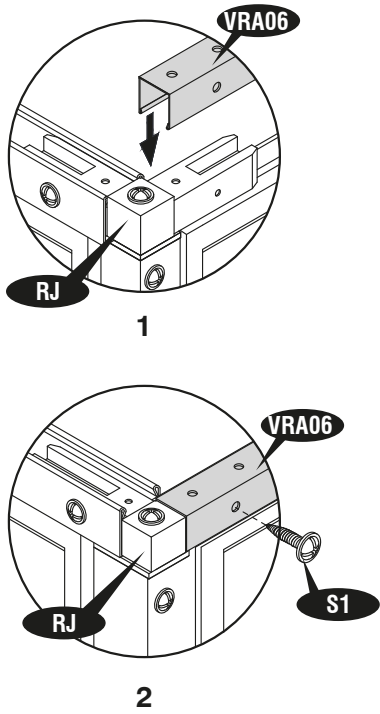
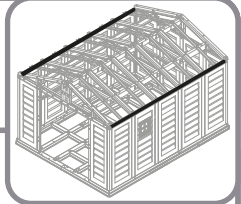

7



S1 (x8)

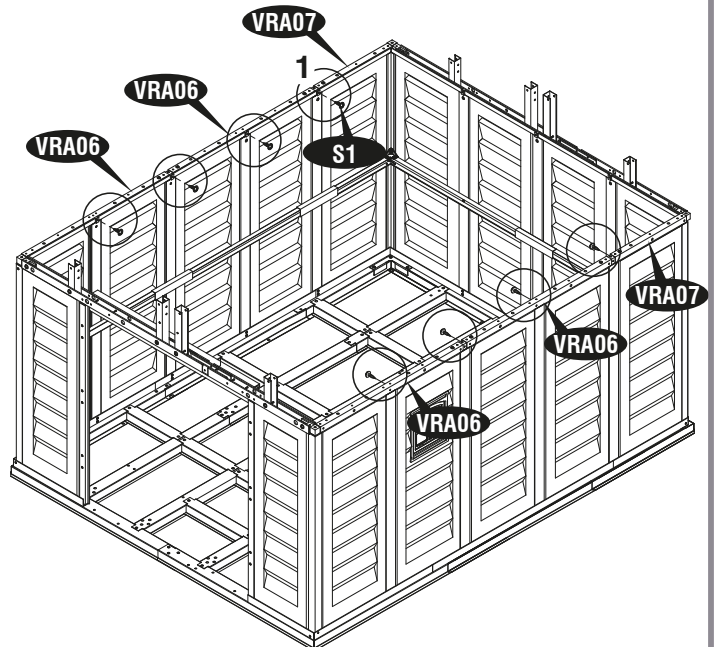
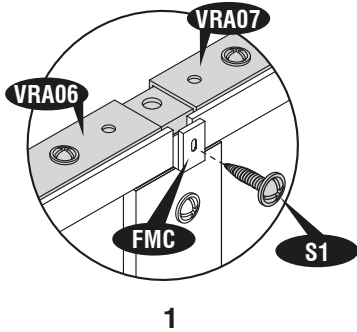
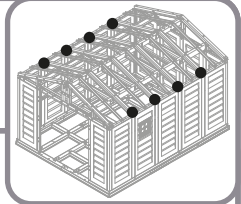

8

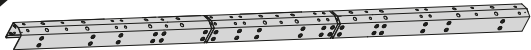

F (x1)



S1 (x8)

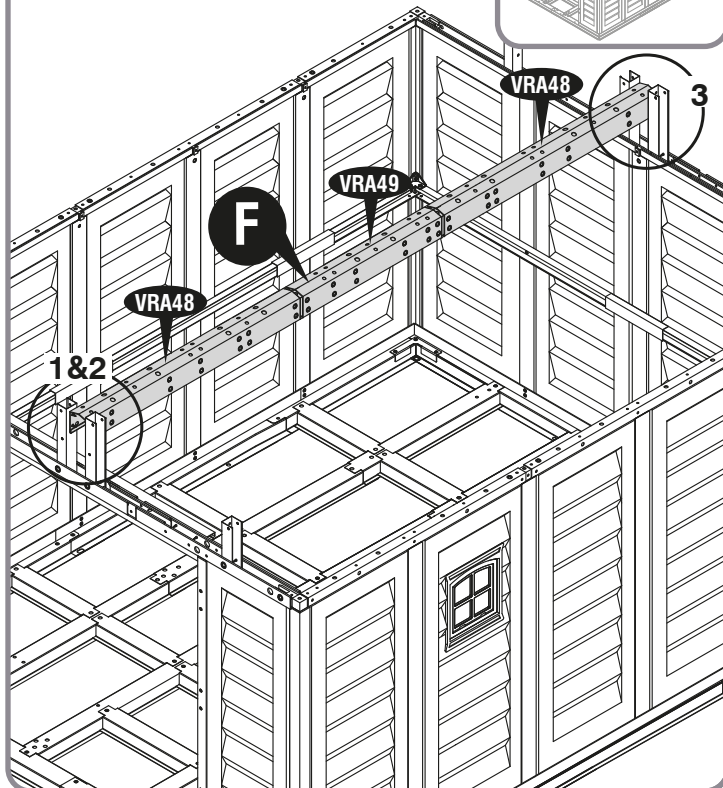
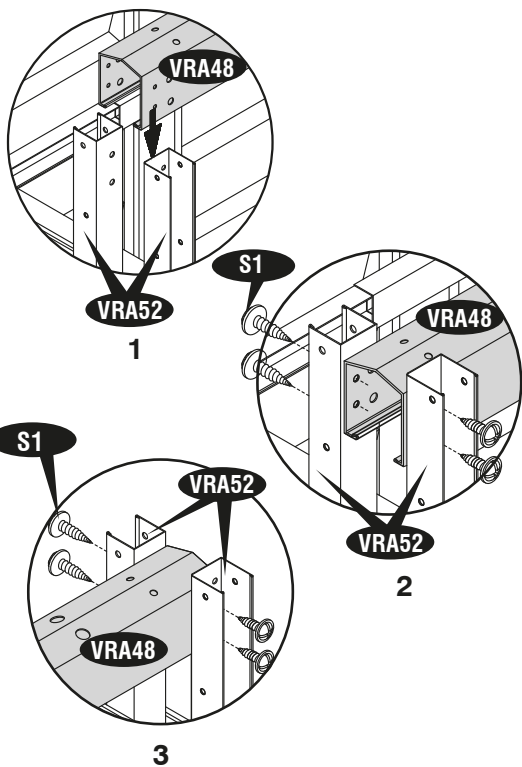
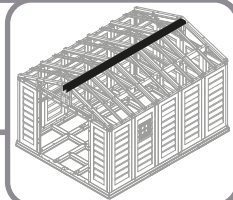

9



VRA14 (x2)  
VRA15 (x2)



S1 (x20)

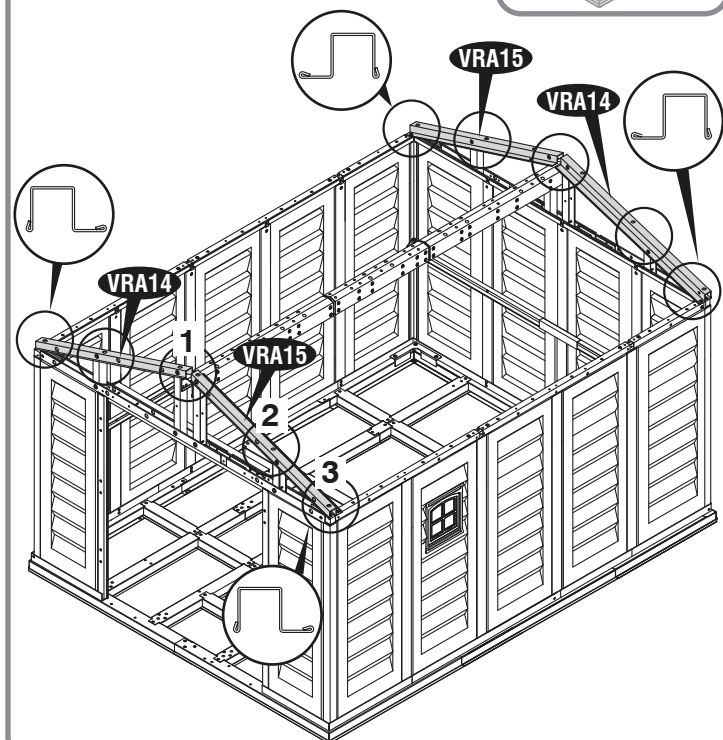
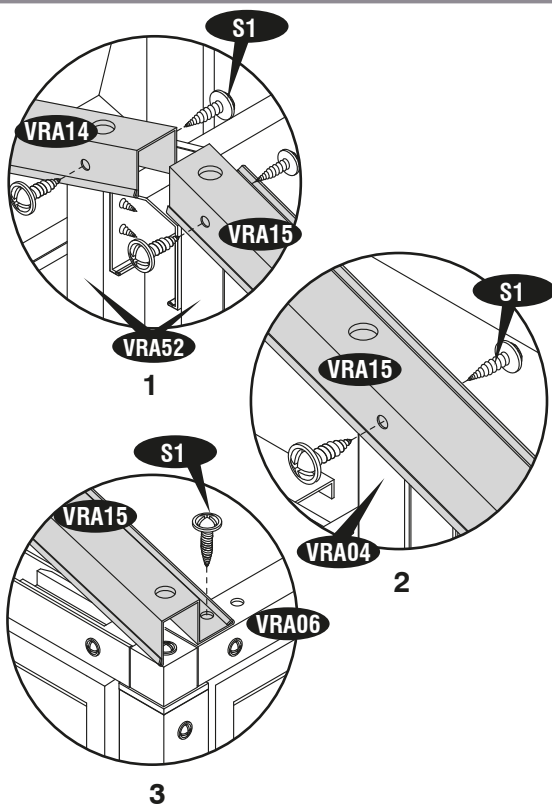
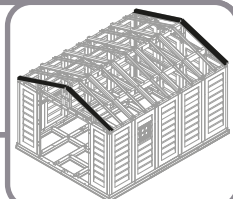

10

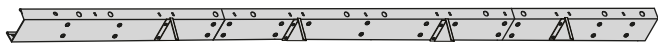

G (x2)



S1 (x8)

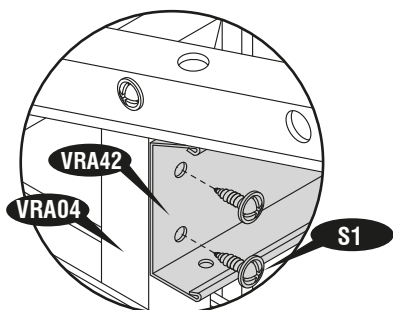
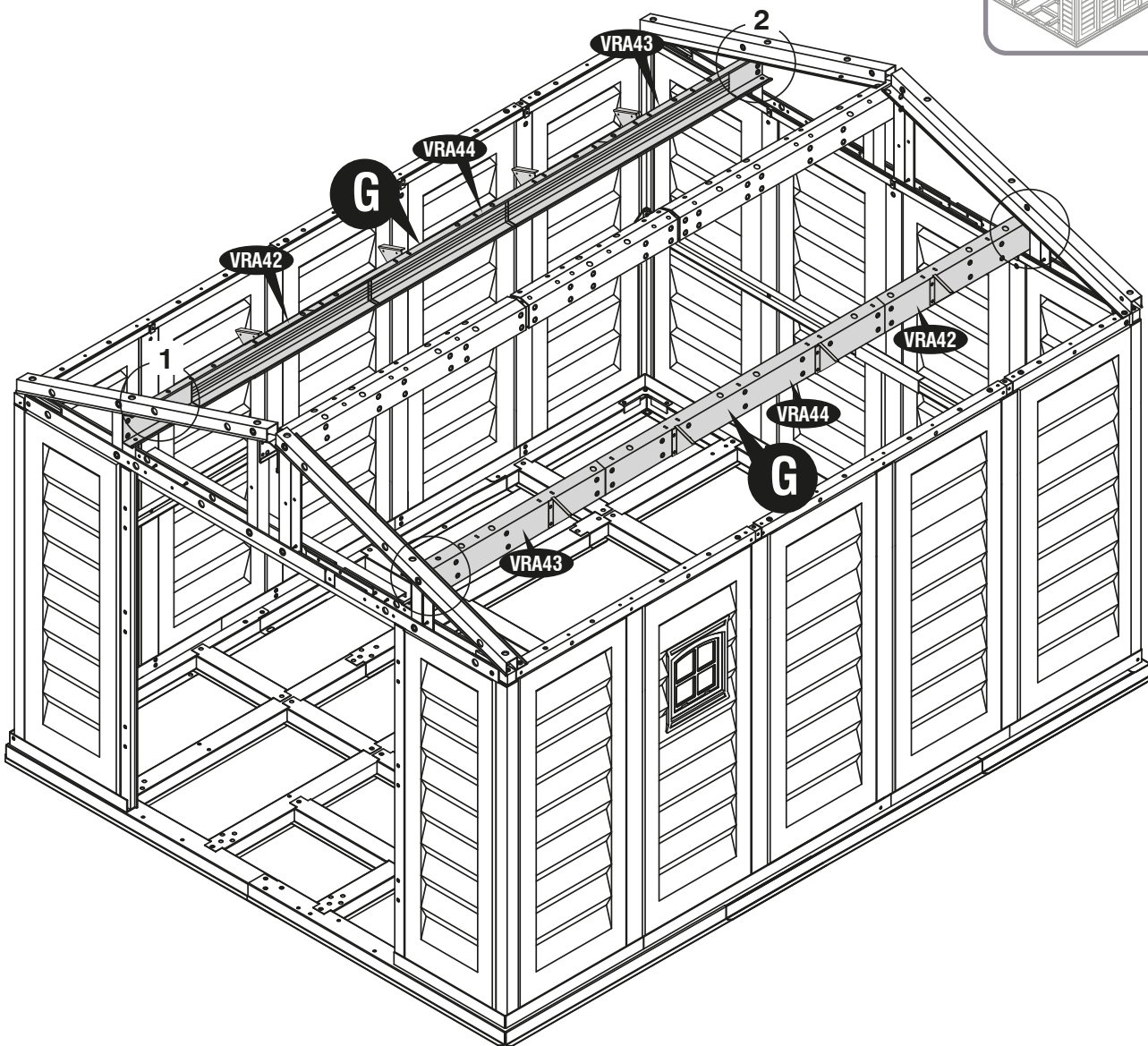
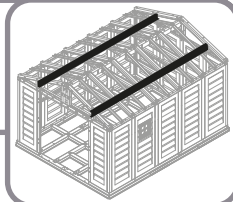

1

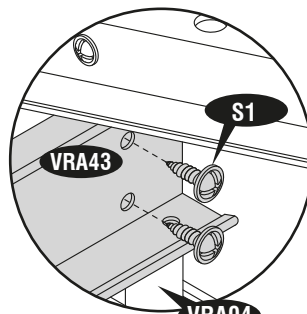

2



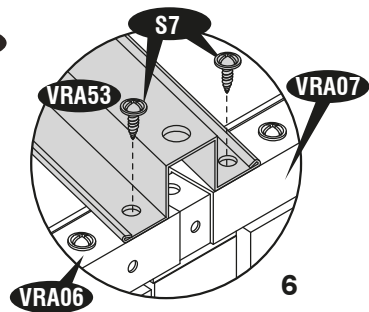
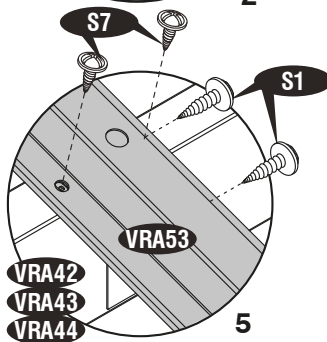
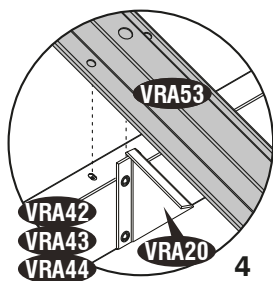
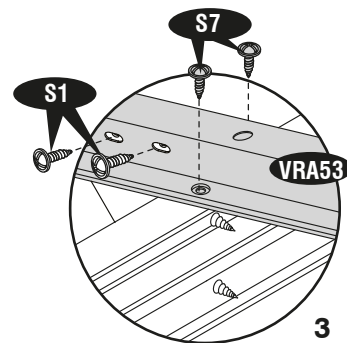
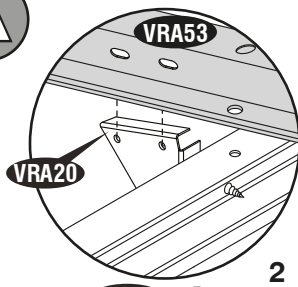
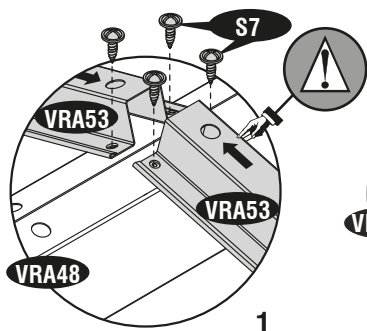
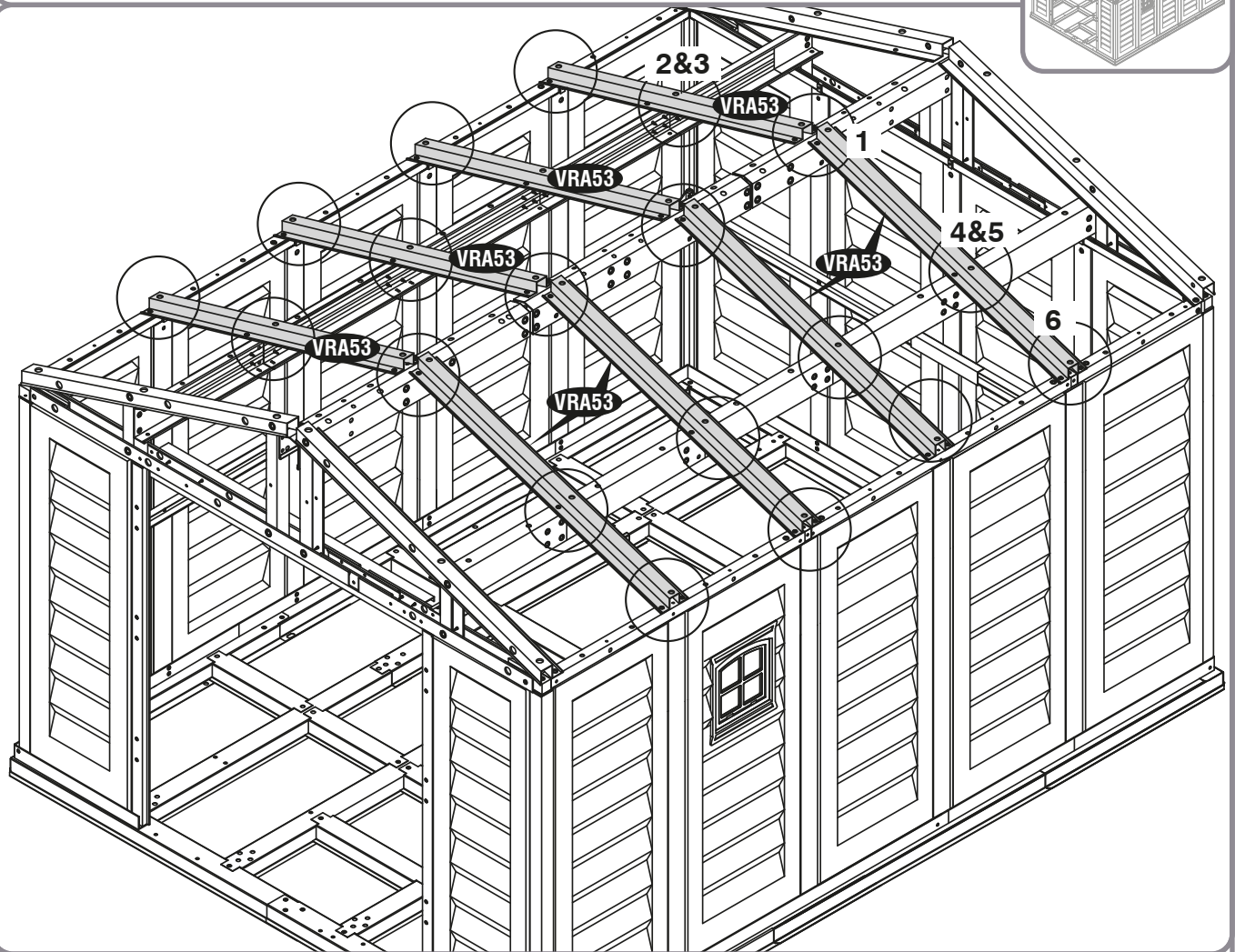
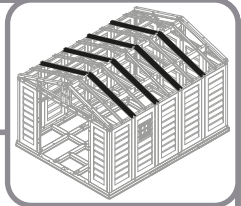
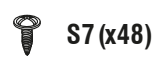
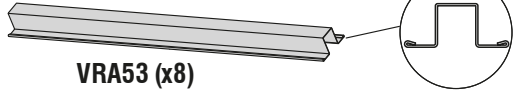

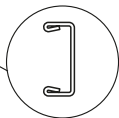
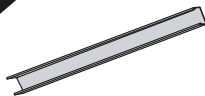

VRA54 (x10)



S7 (x30)

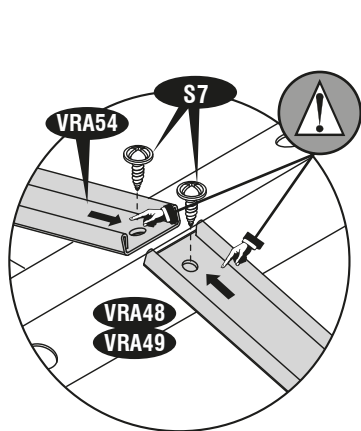
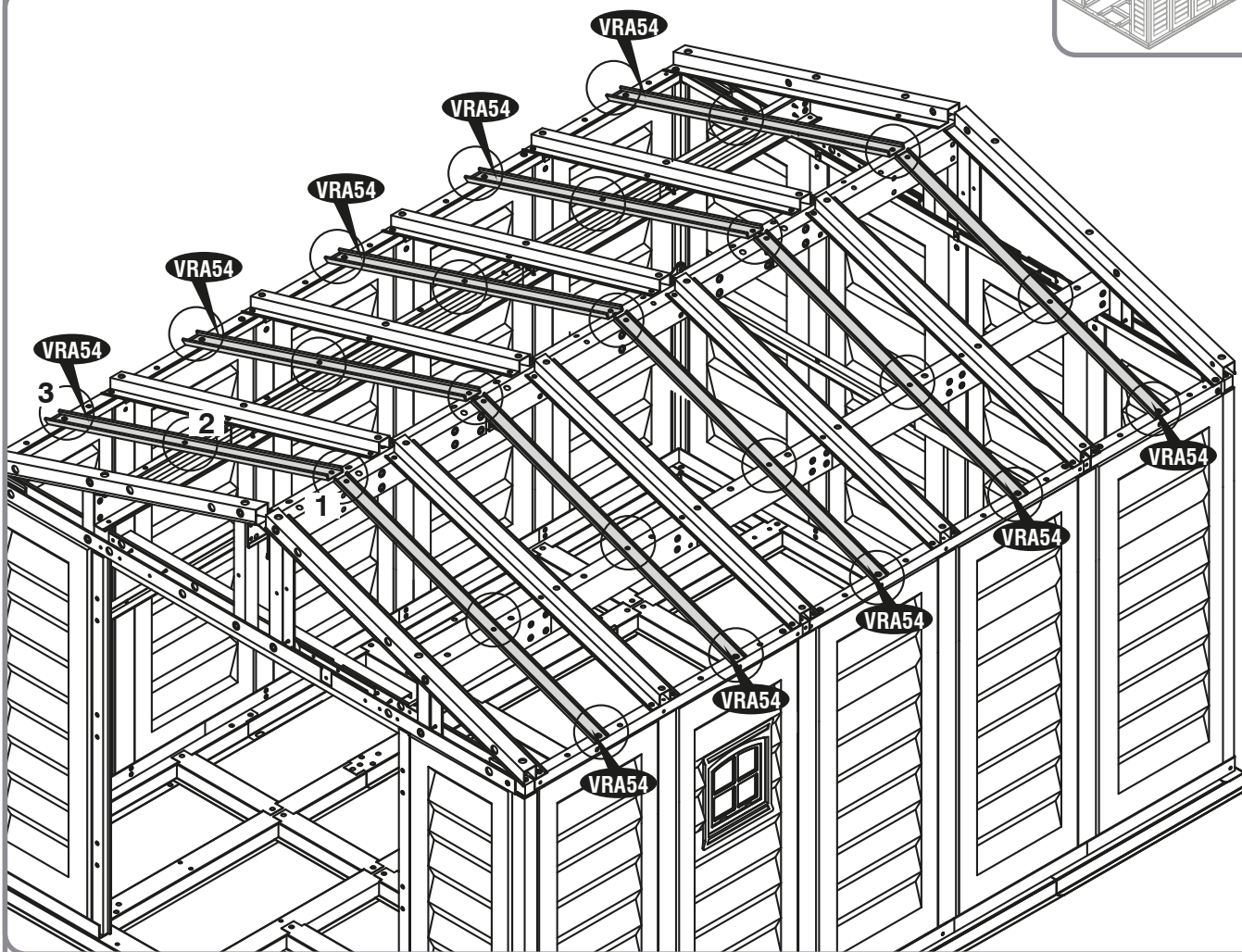
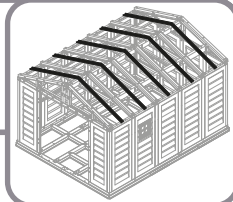

1

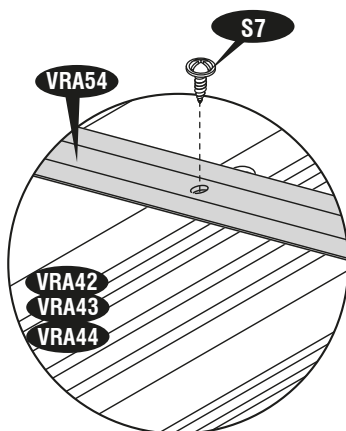

2

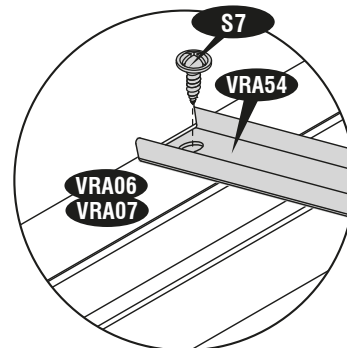

3

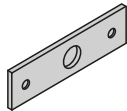

VRA19 (x2)



S1 (x4)

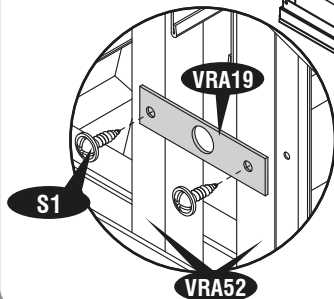
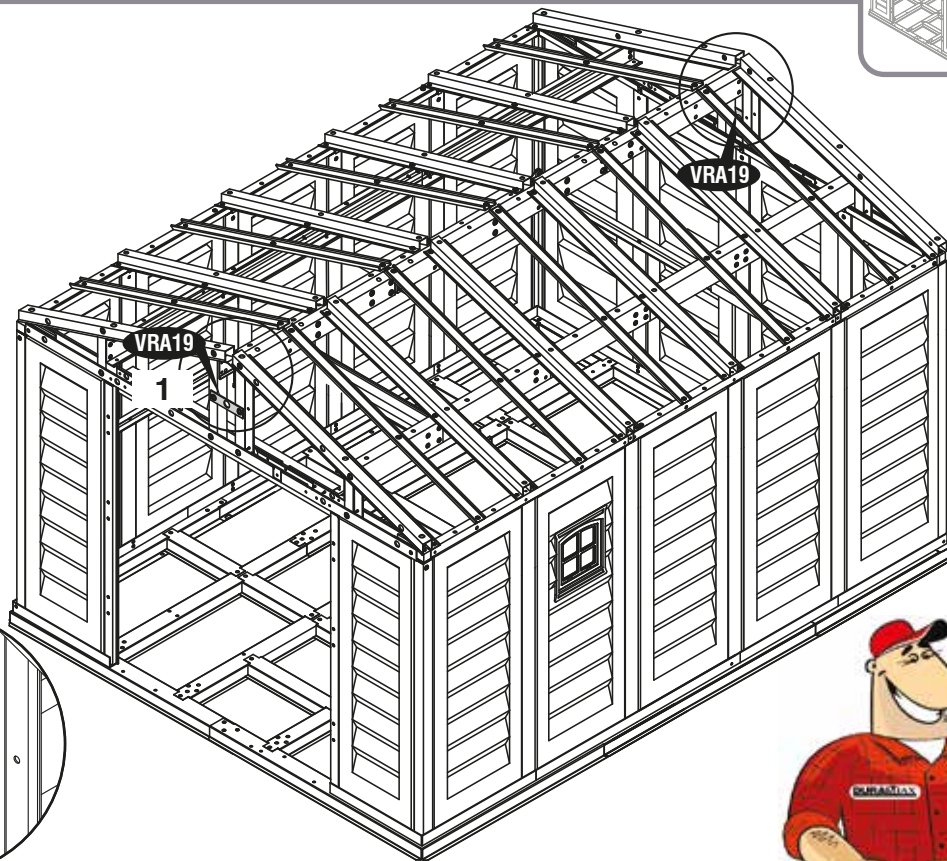
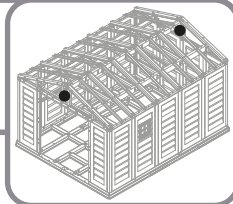

- EN** If planning to add 'SUPER SUPPORT KIT', please install after this step. (Not included).
- FR** Si vous prévoyez d'ajouter «SUPER SUPPORT KIT», veuillez installer après cette étape (non inclus).
- DE** Wenn Sie das SUPER SUPPORT KIT hinzufügen möchten, installieren Sie es bitte nach diesem Schritt (nicht im Lieferumfang enthalten).
- ES** Si planea agregar "KIT DE SÚPER SOPORTE", instálolo después de este paso (no incluido).
- PT** Se você planeja adicionar o "SUPER SUPPORT KIT", instale após esta etapa. (Não incluído).
- NL** Als u van plan bent 'SUPER SUPPORT KIT' toe te voegen, installeer dan na deze stap. (Niet inbegrepen).
- CS** Pokud plánujete přidat „SUPER SUPPORT KIT“, nainstalujte prosím po tomto kroku (není součástí).
- SK** Ak plánujete pridať „SUPER SUPPORT KIT“, nainštalujte ju po tomto kroku. (Nie je súčasťou).
- SL** Če nameravate dodati "SUPER SUPPORT KIT", ga namestite po tem koraku. (Ni priloženo).
- HR** Ako planirate dodati "SUPER SUPPORT KIT", instalirajte ga nakon ovog koraka (nije uključeno).
- HU** Ha a „SUPER SUPPORT KIT“ hozzáadását tervezi, kérjük, telepítse ezt a lépést követően (nem tartozék).
- SV** Om du planerar att lägga till 'SUPER SUPPORT KIT', installera efter detta steg (ingår inte).
- IT** Se hai intenzione di aggiungere "SUPER SUPPORT KIT", installa dopo questo passaggio. (Non incluso).
- PL** Jeżeli planujesz dodać „SUPER SUPPORT KIT“, zainstaluj po tym kroku (brak w zestawie).
- RO** Dacă intenționați să adăugați „SUPER SUPORT KIT“, vă rugăm să instalați după acest pas (nu este inclus).
- BG** Ако планирате да добавите „SUPER SUPPORT KIT“, моля, инсталирайте след тази стъпка (не е включена).
- TR** "SÜPER DESTEK KİTİ" eklemeyi planlıyorsanız, lütfen bu adımdan sonra yükleyin. (Dahil değil).





6

EN Roof Panels	CS Střešní panely	IT Pannelli del tetto
FR Planches de Toiture	SK Strešné panely	PL Panele dachowe
DE Dachplatten	SL Strešni Paneli	RO Panouri de acoperiș
ES Paneles de techo	HR Krovne ploče	BG Покривни панели
PT Painéis do Telhado	HU Tetőpanelek	TR Çatı Panelleri
NL Dakpanelen	SV Takpaneler	

EN Parts needed	CS Potřebné součásti	IT Parti occorrenti
FR Pièces nécessaires	SK Potrebne časti	PL Niezbędne elementy
DE Benötigte Teile	SL Dele, ki jih boste potrebovali	RO Elementele componente necesare
ES Piezas necesitadas	HR Dijelovi potreban	BG Необходими части
PT Peças Necessárias	HU Szükséges részek	TR Gerekli parçalar
NL Onderdelen nodig	SV Delar som behövs	

FPA1	1
FPA2	1
FPA3	1
FPA4	1
RPA1	1
RPA2	3
RPA3	1
RPA4	1

RPA5	3
RPA6	1
PPG	106
PIN	106
PPGL	4
PINL	4
BP	4
EC	2



- EN Apply silicone into the holes before inserting the pins (Silicone not included).
- FR Appliquez de la silicone dans les trous avant d'insérer les broches (silikon nicht enthalten).
- DE Anwenden Silikon in die Löcher vor dem Einsetzen der Stifte (Silikon nicht enthalten).
- ES Aplicar silicona en los agujeros antes de insertar los pasadores (Silicona no incluido).
- PT Aplique silicone nos orifícios antes de inserir os pinos (Silicone não incluído).
- NL Breng siliconen aan in de gaten voordat u de pinnen inbrengt (siliconen niet inbegrepen).
- CS Použijte silikon do otvorů před vložením kolíků (silikon není součástí dodávky).
- SK Silikón naneste do otvorov pred vložením kolíkov (silikón nie je súčasťou dodávky).
- SL Vstavite silikon v luknje, preden vstavite zatič (silikon ni priložen).
- HR Nanesite silikon u rupe prije umetanja igle (Silikonski dio nije uključen).
- HU A tük behelyezése előtt szilikont kell behelyezni a lyukba (a szilikon nem tartozék).
- SV Applicera silikon i hålen innan du sätter in stiften (Silikon ingår inte).
- IT Applicare il silicone nei fori prima di inserire i perni (non in silicone).
- PL Stosuje się silikon w otwory przed włożeniem szpilki (nie zawiera silikonu).
- RO Aplicați siliconul în orificii înainte de a introduce știfturile (siliconul nu este inclus).
- BG Нанесете силикон в дупките преди да поставите щифтовете (силикон не са включени).
- TR Pimleri yerleştirmeden önce deliğe silikon uygulayın (Silikon dahil değildir).

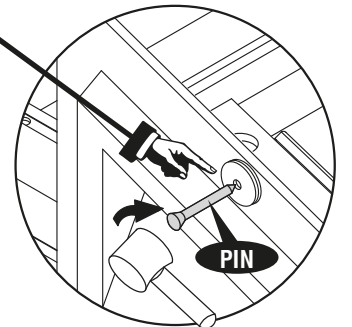
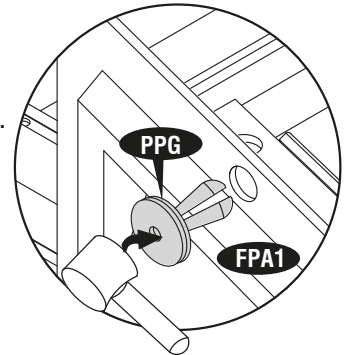



- EN** Insert roof plugs into Fascia Panel only as indicated.  
Use the same colour Plugs & Pins (PPG & PIN) to fix the Roof Panels & Fascia Panels .  
Use a screwdriver to align the holes.
- FR** Insérez les bouchons de toit dans le panneau Fascia uniquement comme indiqué.  
Utilisez les mêmes fiches et broches de couleur (PPG et PIN) pour fixer les panneaux de toit et les panneaux de façade.  
Utilisez un tournevis pour aligner les trous
- DE** Dachstopfen nur wie angegeben in das Fascia Panel einstecken.  
Verwenden Sie die gleichen Plugs & Pins (PPG & PIN) zur Befestigung der Dachverkleidungen und Blenden.  
Verwenden Sie einen Schraubendreher, um die Löcher auszurichten.
- ES** Inserte los enchufes del techo en el panel frontal solo como se indica.  
Utilice el mismo color Plugs & Pins (PPG & PIN) para fijar los paneles del techo y los paneles de la fascia.  
Use un destornillador para alinear los agujeros.
- PT** Insira os plugues do teto no Painel de Fáschia somente conforme indicado.  
Use a mesma cor Plugs & Pins (PPG & PIN) para fixar os Painéis de Teto e Painéis de Fáschia.  
Use uma chave de fenda para alinhar os orifícios.
- NL** Steek dakdoppen alleen in het Fascia-paneel zoals aangegeven.  
Gebruik dezelfde plugs & pinnen (PPG & pincode) om de dakenpanelen en fascia-panelen te bevestigen.  
Gebruik een schroevendraaier om de gaten uit te lijnen.
- CS** Zasuňte střešní zátky do panelu Fascia pouze podle pokynů.  
Použijte stejnou barvu Plug & Pins (PPG & PIN) k upevnění panelů střešních panelů a fasád.  
Vyrovnajte otvory pomocí šroubováku.
- SK** Zasuňte strešnú zásuvku do panelu Fascia iba podľa pokynov.  
Používajte rovnakú farbu Zástrčky a kolíky (PPG a PIN) na upevnenie panelov strešných panelov a fasád.  
Otvory zarovnajte pomocou skrutkovača.
- SL** Vstavite strešne čepe na ploščo Fascia samo, kot je navedeno.  
Uporabite iste barvne vtičnice in zatiči (PPG in PIN), da popravite plošče plošč in plošč.  
Za poravnavo lukenj uporabite izvijač.
- HR** Utaknite krovne utičnice na Fascia Panel samo kao što je navedeno.  
Koristite iste boje Utikači i igle (PPG & PIN) kako biste popravili ploče krovnih panela i fascije.  
Upotrijebite odvijač za poravnavanje rupa.
- HU** Helyezze be a tetőcsatlakozókat a Fascia Panelbe, csak a jelzett módon.  
Használja ugyanazt a színű dugókat és tűket (PPG és PIN) a tetőpanelek és a panelek rögzítéséhez.  
Csavarhúzóval igazítsa a lyukakat.
- SV** Sätt in takpluggarna i Fascia Panel endast enligt anvisningarna.  
Använd samma färg Pluggar & Pins (PPG & PIN) för att fixa takpaneler & Fascia Panels.  
Rikta in hålen med en skruvmejsel.
- IT** Inserire i tappi per tetto nel pannello frontale solo come indicato.  
Utilizzare lo stesso colore Plug e pin (PPG e PIN) per fissare i pannelli del tetto e i pannelli della fascia.  
Utilizzare un cacciavite per allineare i fori.
- PL** Włóż kołki dachowe w panel konsoli tylko zgodnie z opisem.  
Użyj tego samego koloru Zatyczki i kołki (PPG i PIN), aby przymocować panele dachowe i panele konsoli.  
Użyj śrubokręta, aby wyrównać otwory.
- RO** Introduceți dopurile de acoperiș în panoul Fascia numai după cum este indicat.  
Utilizați aceleași culori Plug & Pin (PPG & PIN) pentru a fixa Panourile de acoperiș și panourile Fascia.  
Folosți o șurubelniță pentru a alinia găurile.
- BG** Поставете покривните тапи в Fascia Panel само, както е показано.  
Използвайте същите цветове Plugs & Pins (PPG & PIN), за да фиксирате панелите на покрива и панелите.  
Използвайте отвертка, за да подравните дупките.
- TR** Tavan fişlerini sadece gösterildiği gibi Ön Panoya takın.  
Çatı Panelleri ve Fasya Panellerini sabitlemek için aynı renkte Fiş ve Pimler (PPG & PIN) kullanın.  
Delikleri hizalamak için bir tornavida kullanın.



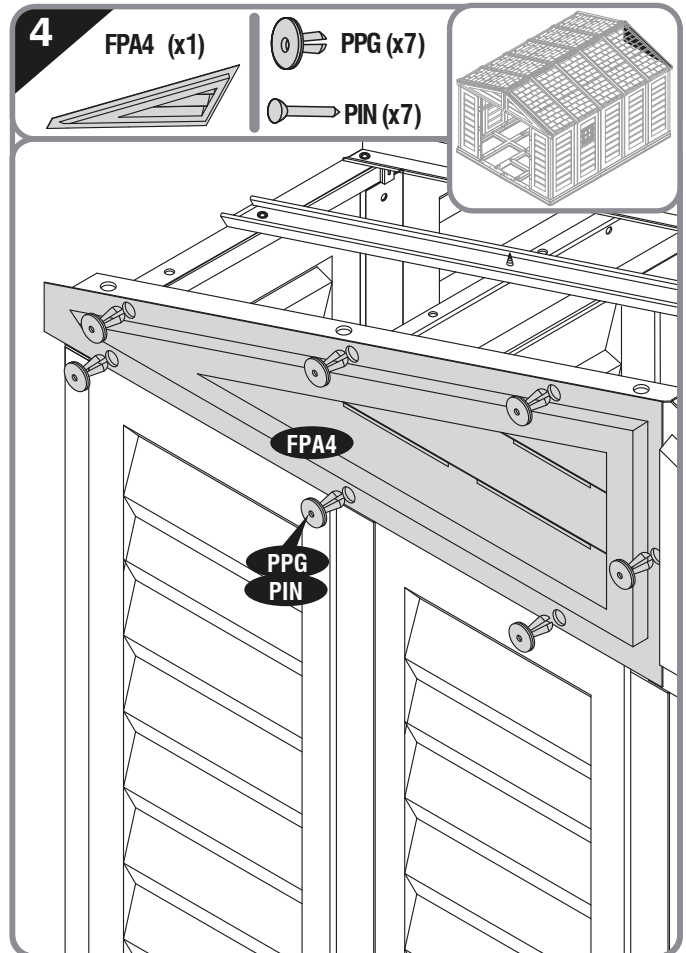
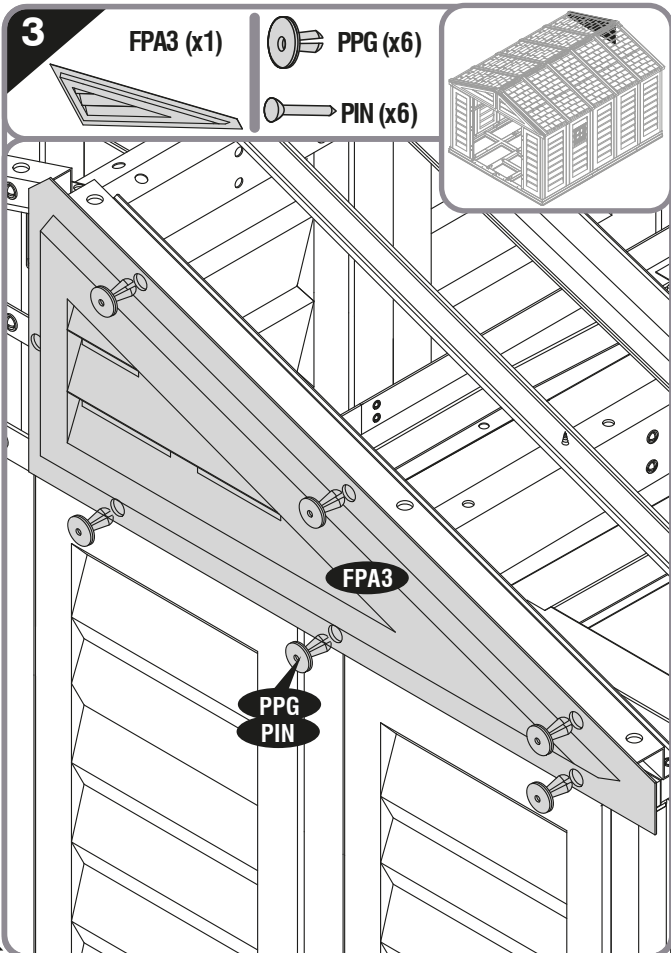
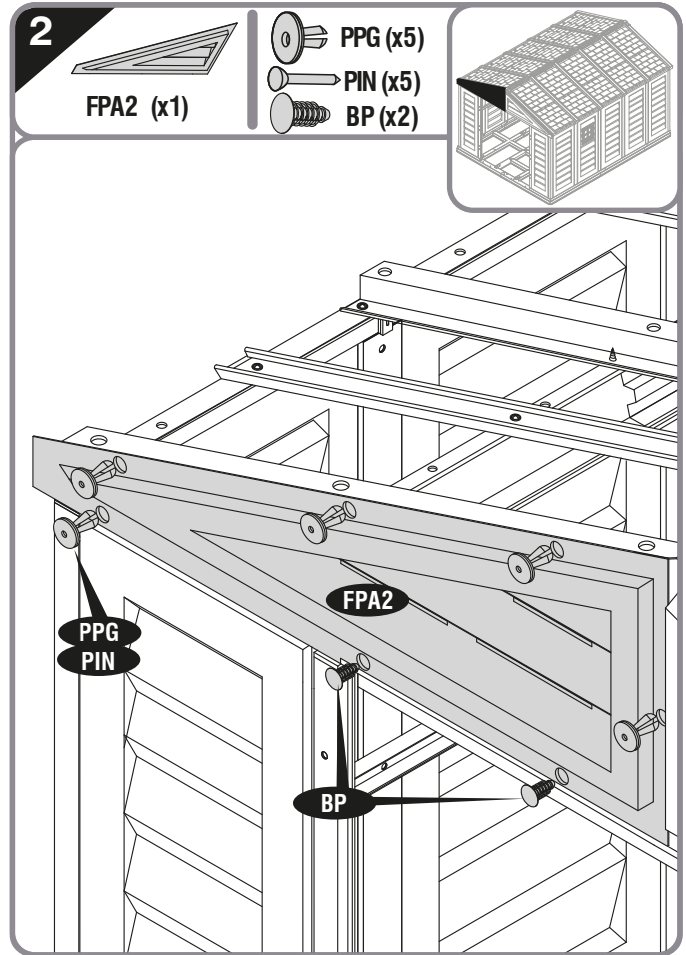
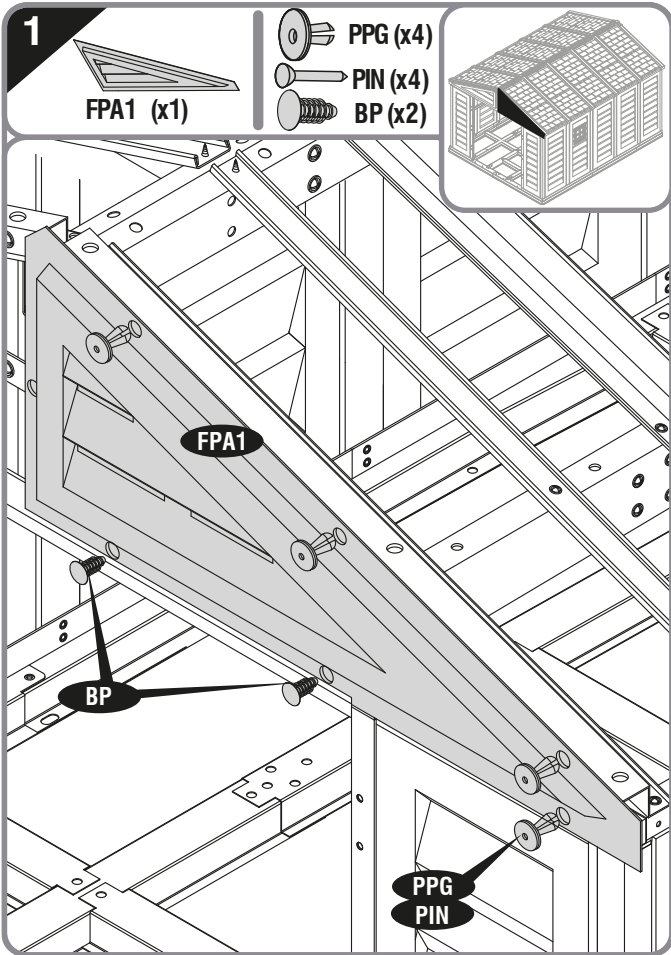

5

RPA1 (x1)

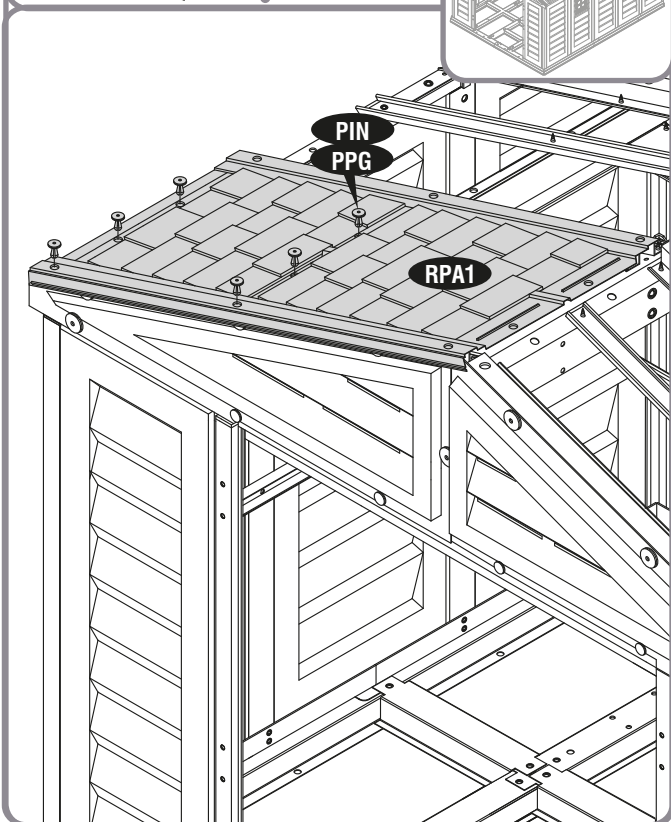
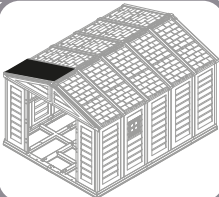
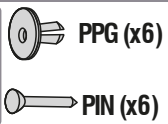
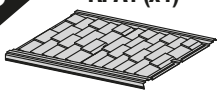

6

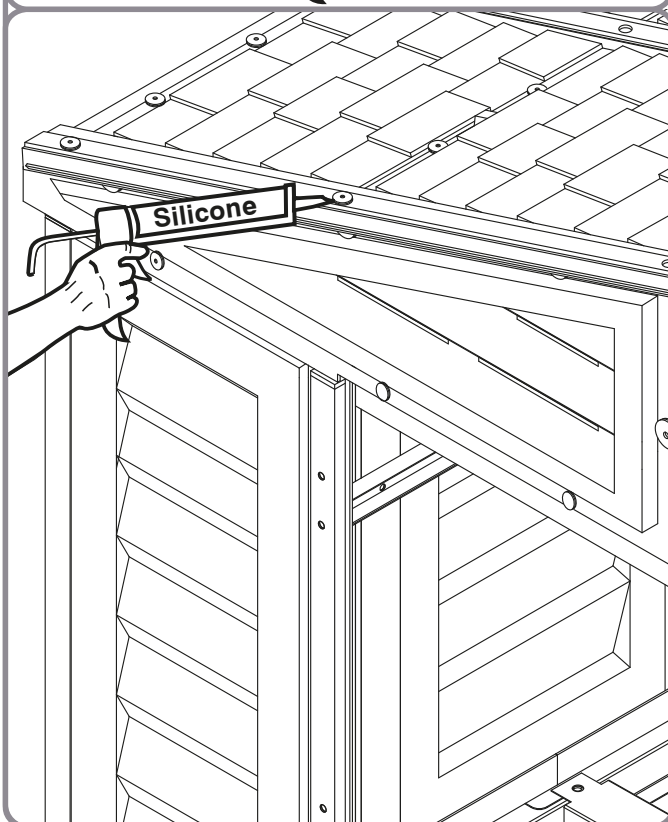

7

RPA2 (x1)

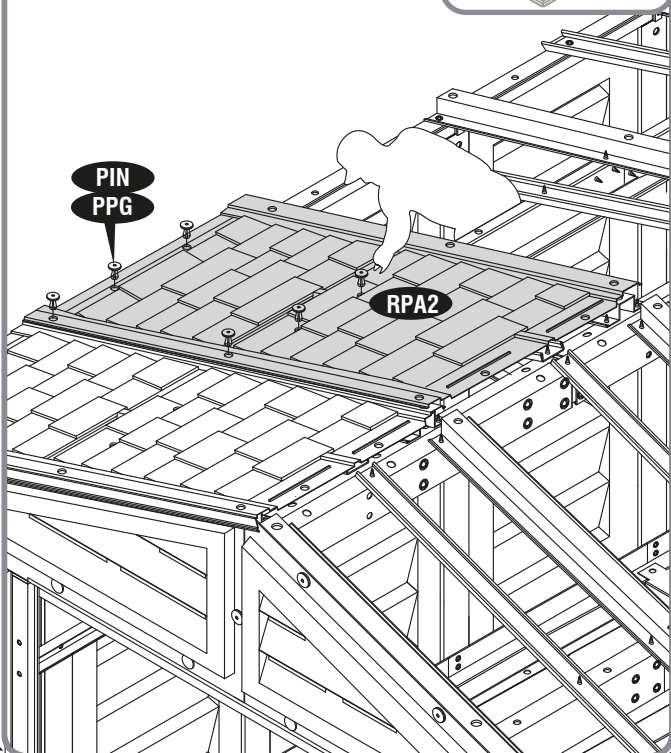
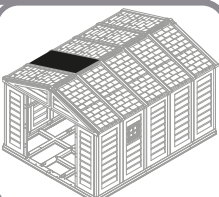
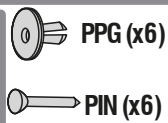
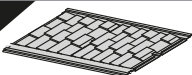

8

RPA2 (x1)

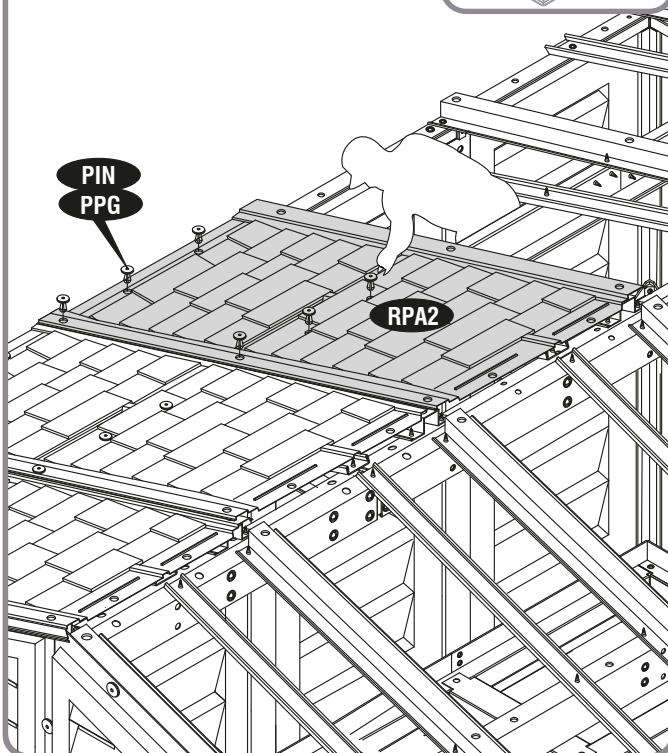
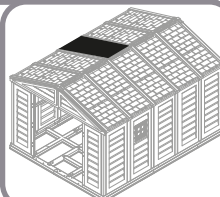
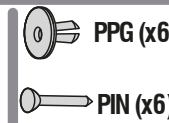
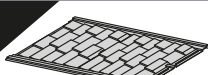



**9**

RPA2 (x1)

PPG (x6)

PIN (x6)

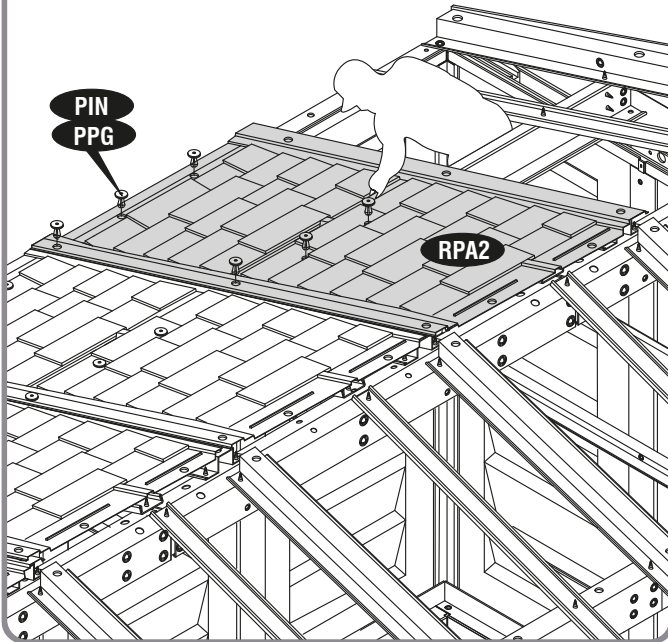

**10**

RPA3 (x1)

PPG (x8)

PIN (x8)

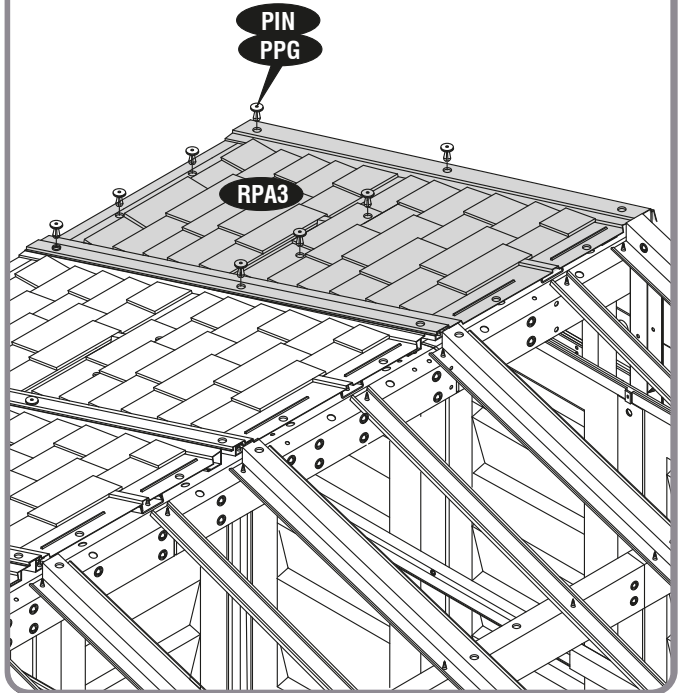

**11**

RPA4 (x1)

PPG (x10)

PIN (x10)

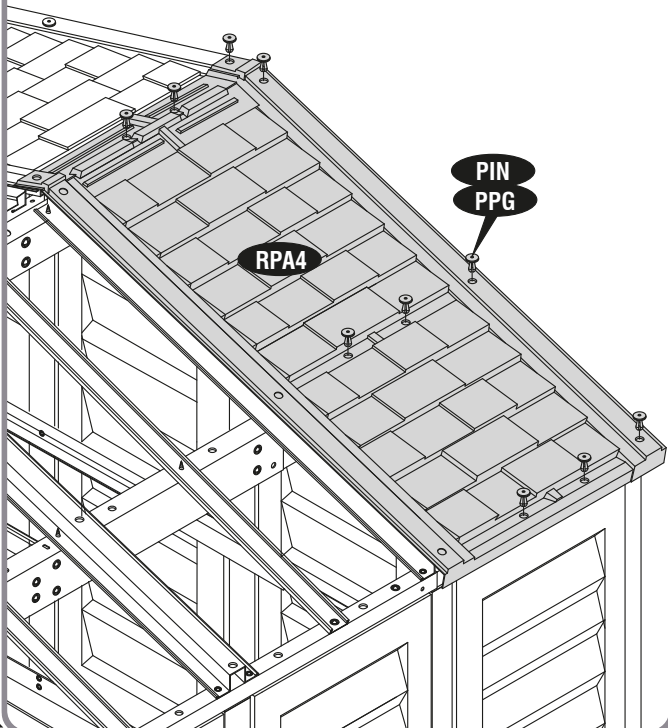

**12**

RPA5 (x1)

PPG (x9)

PPGL (x1)

PIN (x9)

PINL (x1)

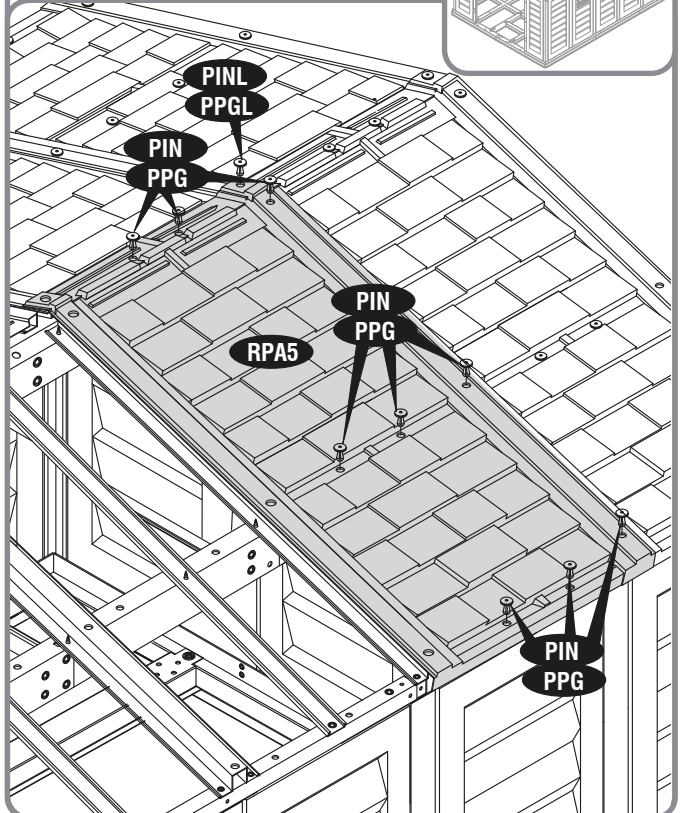



13

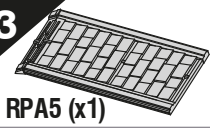

RPA5 (x1)

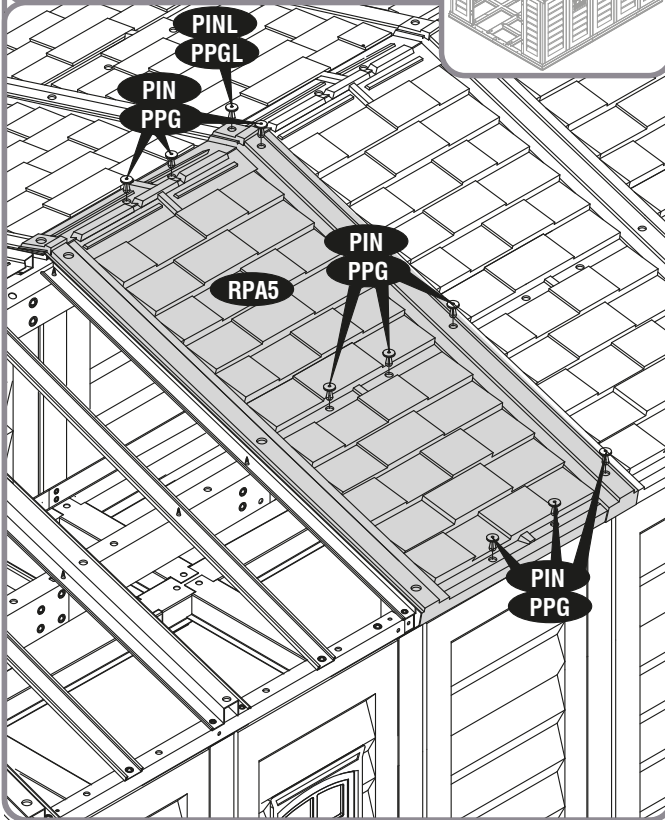
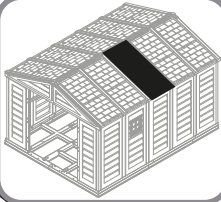
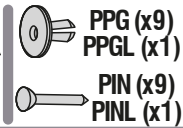

14

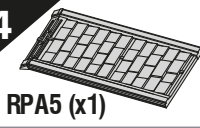

RPA5 (x1)

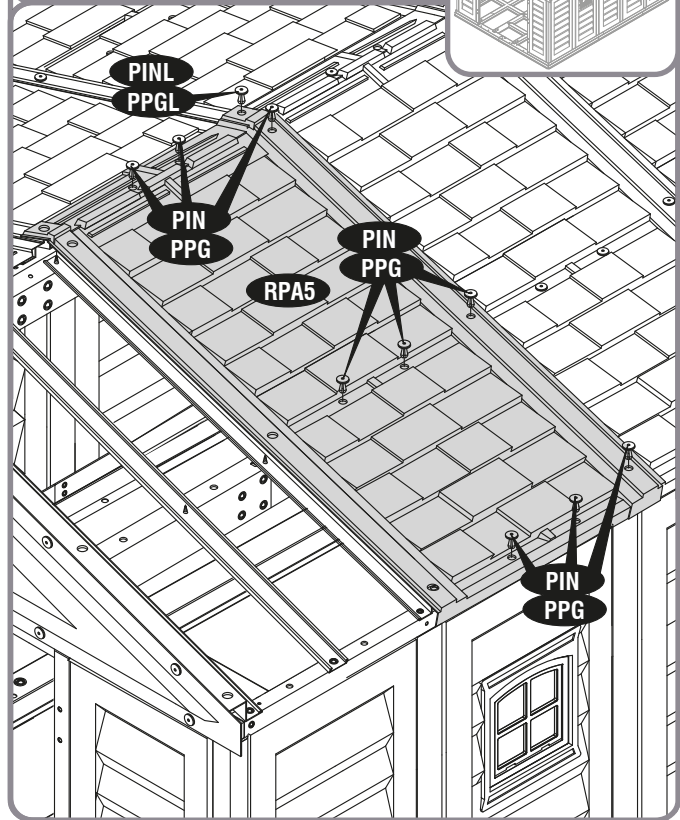
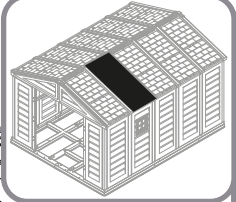
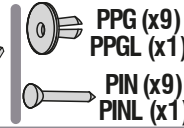

15

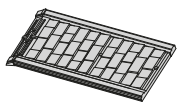

RPA6 (x1)

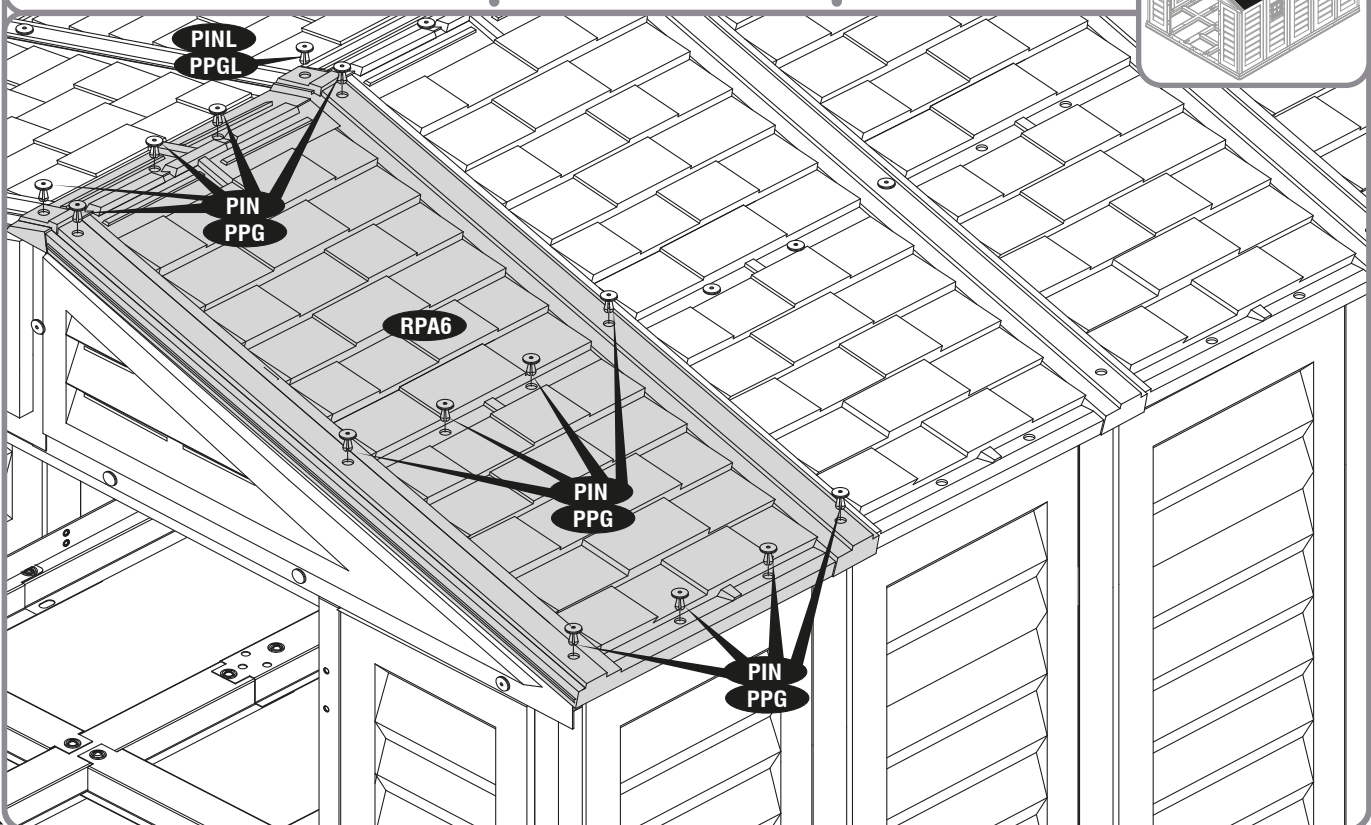
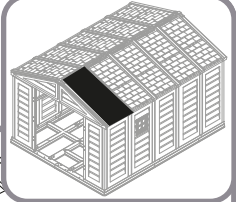

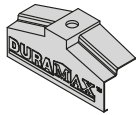

EC (x2)



PPG (x2)



PIN (x2)

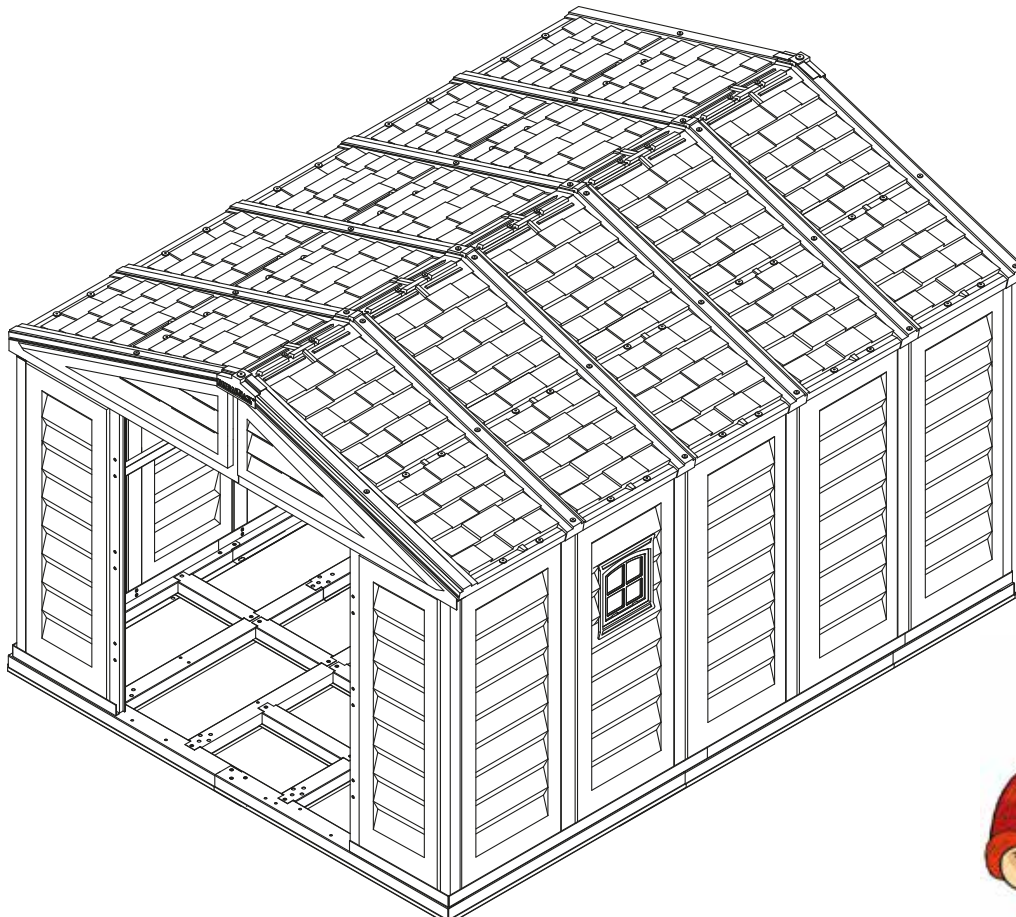
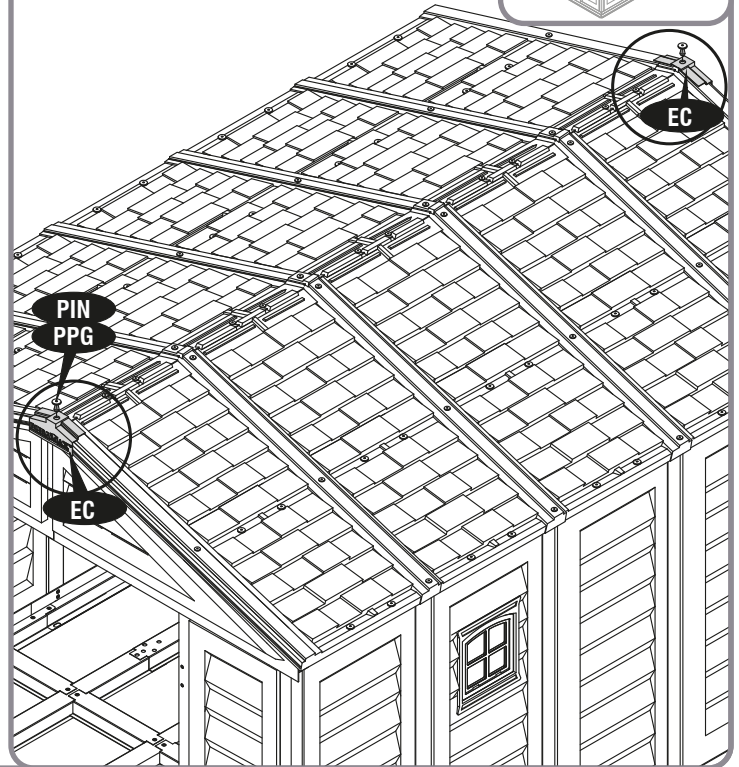
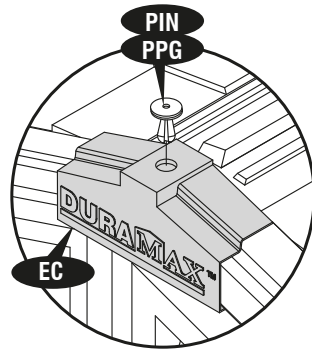
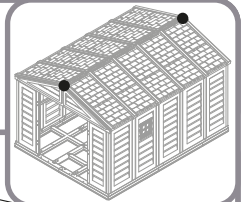



7

EN Door

FR Porte

DE Die Tür

ES La puerta

PT Porta

NL De deur

CS Dveře

SK Dvere

SL Vrata

HR Vrata

HU Ajtó

SV Dörr

IT Porta

PL Drzwi

RO Ușa

BG Врата

TR Kapı

EN Parts needed

FR Pièces nécessaires

DE Benötigte Teile

ES Piezas necesarias

PT Peças Necessárias

NL Onderdelen nodig

CS Potřebné součásti

SK Potrebne časti

SL Dele, ki jih boste potrebovali

HR Dijelovi potreban

HU Szükséges részek

SV Delar som behövs

IT Parti occorrenti

PL Niezbędne elementy

RO Elementele componente necesare

BG Необходими части

TR Gerekli parçalar

DL	1	L	1
DR	1	R	1
LH	3	SBC1	28
RH	3	PW	28



1

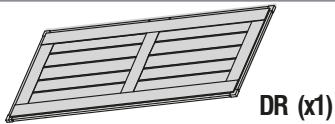

DR (x1)

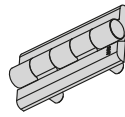

RH↑ (x2)



SBC1 (x4)

PW (x4)

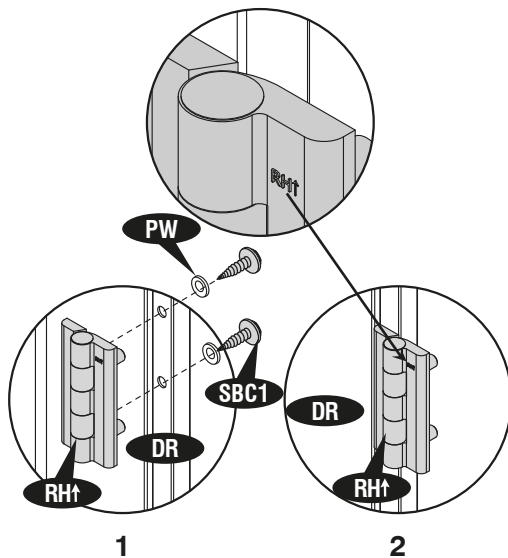
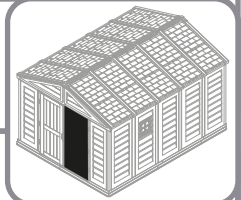

1

2

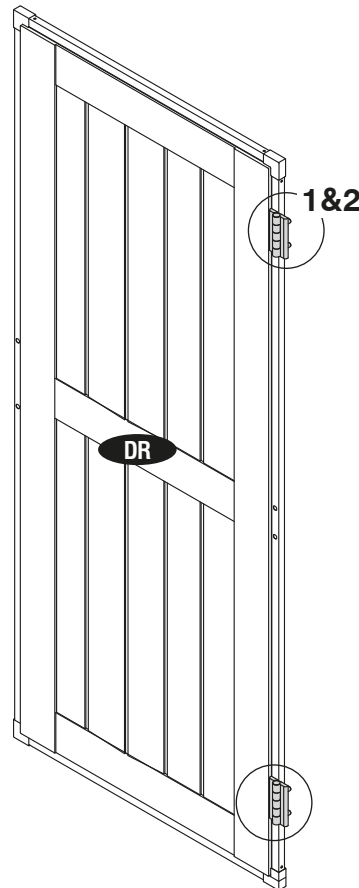

EN Right Door

FR Porte droite

DE Rechte Tür

ES Puerta derecha

PT Porta direita

NL Rechter deur

CS Pravé dveře

SK Pravé dvere

SL Desna vrata

HR Desna vrata

HU Jobb ajtó

SV Höger dörr

IT Porta Destra

PL Prawe drzwi

RO Usa dreapta

BG Дясна врата

TR Sağ kapı

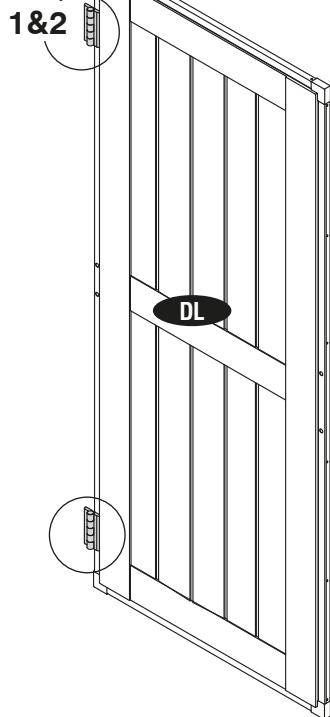
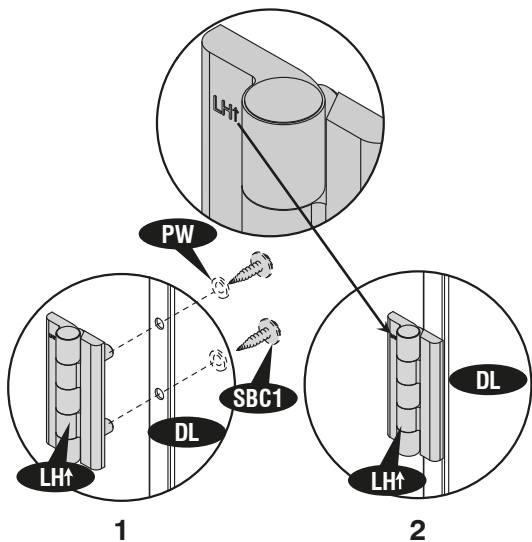
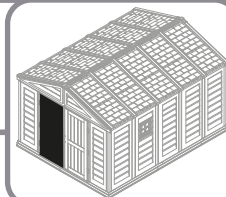
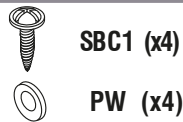
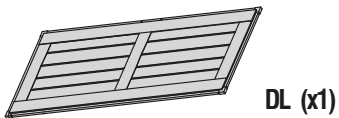

**2**

- EN Left Door
- FR Porte gauche
- DE Linke Tür
- ES Puerta izquierda
- PT Porta esquerda
- NL Linker deur
- CS Levé dveře
- SK Ľavé dvere
- SL Leva vrata
- HR Lijeva vrata
- HU Bal ajtó
- SV Vänster dörr
- IT Porta Sinistra
- PL Lewe drzwi
- RO Usa stanga
- BG Лява врата
- TR Sol kapı

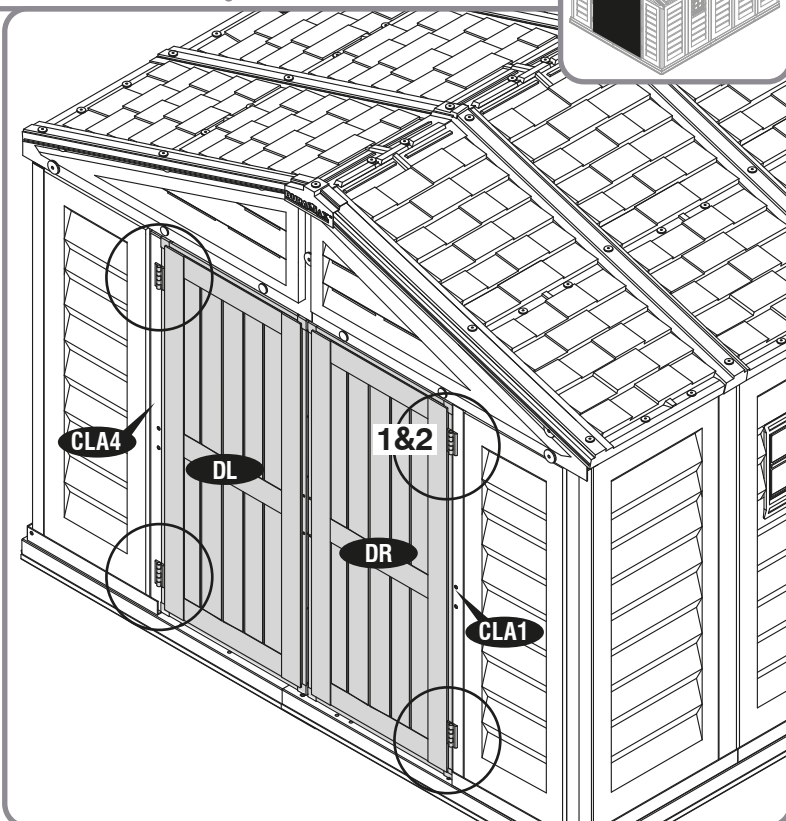
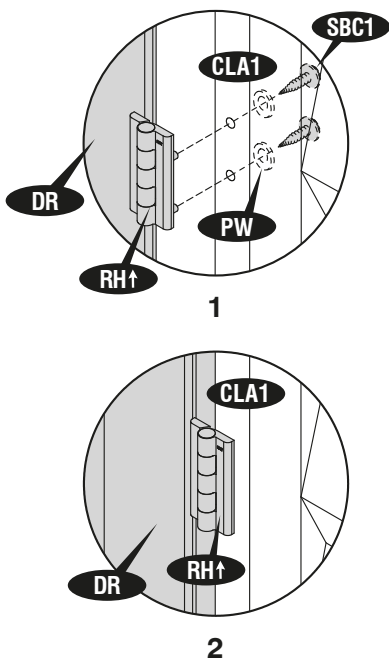
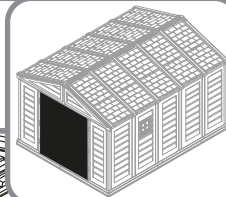
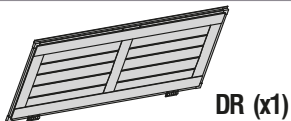
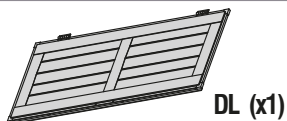
**3**

4

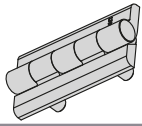

LH↑ (x1)

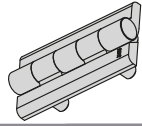

RH↑ (x1)



SBC1 (x8)

PW (x8)

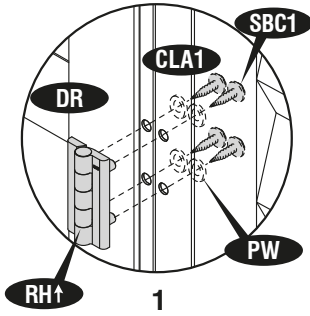
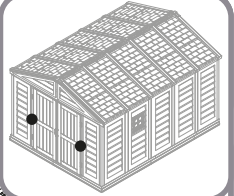

1

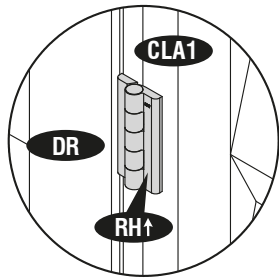

2

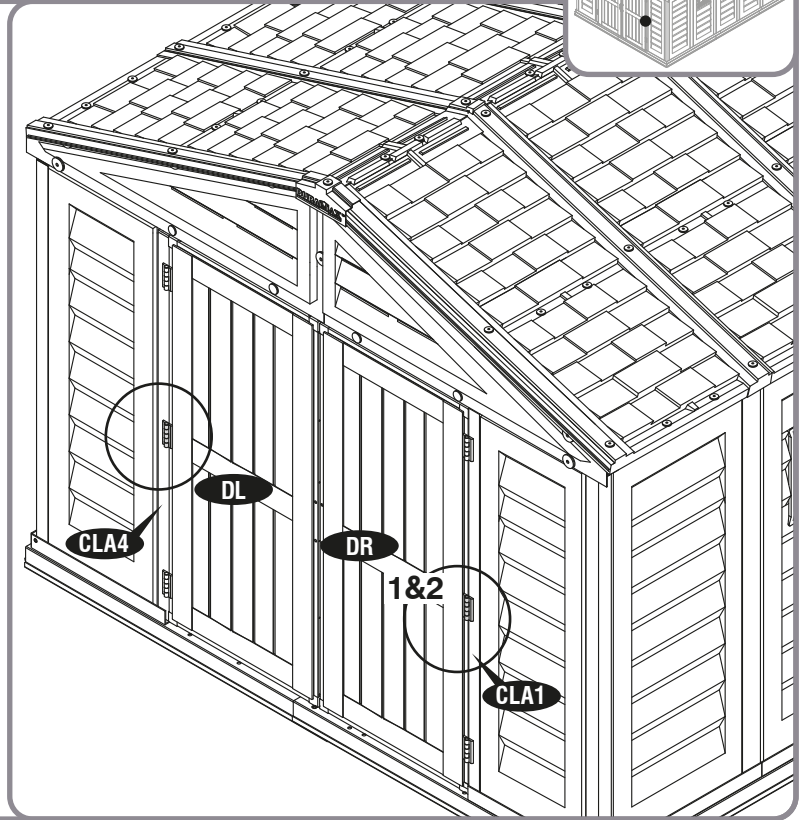

5

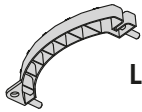

L (x1)

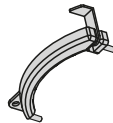

R (x1)



SBC1 (x4)

PW (x4)

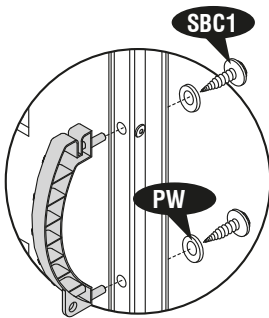
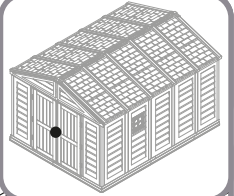

1

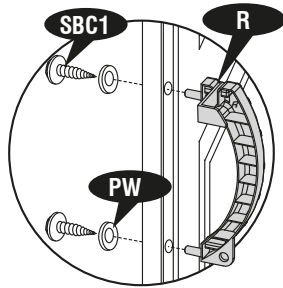

2

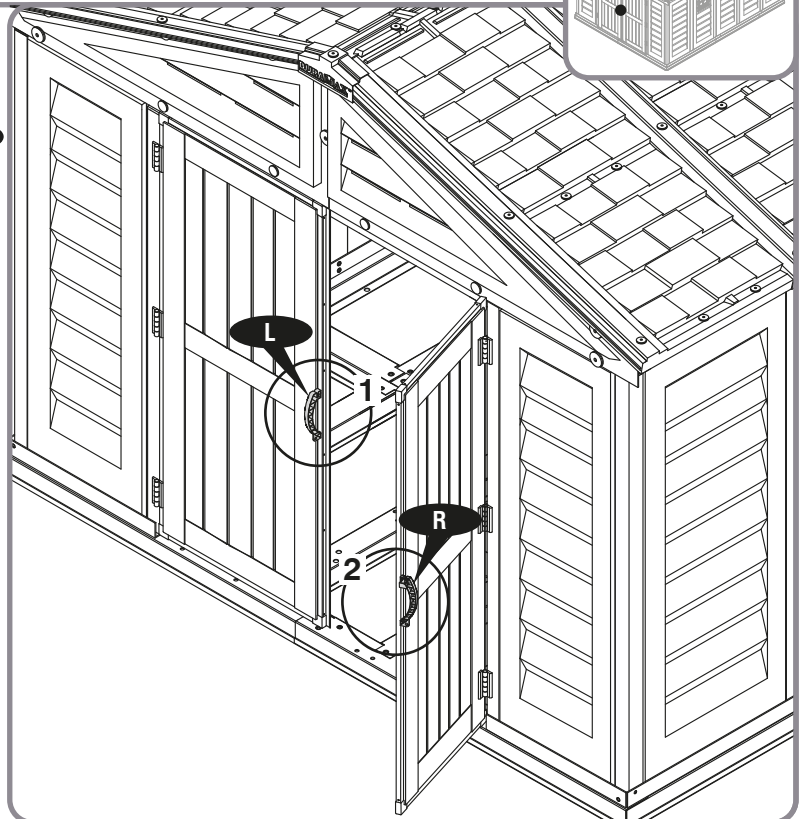
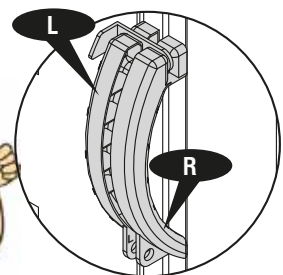



EN Assembly on Concrete Platform	CS Montáž na betonové plošině	IT Montaggio su piattaforma in calcestruzzo
FR Assemblage sur plate-forme en béton	SK Montáž na betonovú plošinu	PL Montaż na betonowej platformie
DE Montage auf Betonplattform	SL Montaža na betonsko ploščad	RO Adunarea pe platforma de beton
ES Montaje en plataforma de hormigón	HR Montaža na betonskoj platformi	BG Монтаж на бетонна платформа
PT Montagem em plataforma de concreto	HU Szerelés beton felületen	TR Beton platform üzerine montaj
NL Montage op betonplatform	SV Montering på betongplattform	



EN Parts needed	CS Potřebné součásti	IT Parti occorrenti
FR Pièces nécessaires	SK Potrebne časti	PL Niezbędne elementy
DE Benötigte Teile	SL Dele, ki jih boste potrebovali	RO Elementele componente necesare
ES Piezas necesarias	HR Dijelovi potreban	BG Необходими части
PT Peças Necessárias	HU Szükséges részek	TR Gerekliler parçalar
NL Onderdelen nodig	SV Delar som behövs	

S2	26
F1	26



- EN** To ensure that your shed withstands high winds, we recommend using this floor option. A concrete pad or large size concrete patio stone squares is recommended for suitable floor base. Make sure it is firm and level and will allow drainage away from the site. Make a level concrete foundation, that has an outside dimension of 129 3/8" x 160 1/2" (3287mm x 4077mm). for Basic Shed. **For a concrete pad base, prepare a level bed for a firm footing layer of crushed stone. The concrete pad should then be poured to a thickness of 4 inches (100mm) to 5 inches (125mm). Allow to dry thoroughly for at least 48 hours. Manufacturer is not responsible for the choice and construction of the foundation.**
- FR** Pour vous assurer que votre hangar résiste à des vents violents, nous avons recommandé d'utiliser cette option de plancher. Une dalle de béton ou une grande taille concrètes dalles de patio de est recommandé pour base appropriée au sol. Assurez-vous qu'il est ferme et niveau et permettre un bon drainage du site. Faire niveau fondation en béton, qui a une dimension extérieure de 129 3/8" x 160 1/2" (3287mm x 4077mm). Pour hanger de base. **Pour une dalle en béton, préparer une couche de graviers de nive au. Le tampon de béton doit ensuite être coulé sur une épaisseur de 4 pouces (100 mm) à 5 pouces (125 mm). Laisser sécher complètement pendant au moins 48 heures. Le fabricant n'est pas responsable du choix et de la construction des fondations.**
- DE** Um sicherzustellen, dass Ihr Schuppen hohen Winden standhält, empfiehlt es sich, diese Bodenoption zu benutzen. Eine konkrete Auflage oder eine große Größe konkreten Patio Stein Quadrate wird empfohlen für die geeignete Standring. Stellen Sie sicher, es ist fest und Ebene und Entwässerung von der Website ermöglicht. Machen Sie eine Ebene Betonfundament, die eine externe Dimension von 129 3/8" x 160 1/2" (3287mm x 4077mm).. **für eine konkrete Auflage hat base, einer soliden Basis Schicht aus Schotter ein Niveau Bett vorzubereiten. Die konkrete Auflage sollte dann zu einer Dicke von 4 Zoll (100 mm) bis 5 Zoll (125 mm) gegossen werden. Gründlich mindestens 48 Stunden trocknen lassen. Hersteller ist nicht verantwortlich für die Auswahl und Konstruktion der Stiftung.**
- ES** Para asegurarse de que su cobertizo resiste vientos fuertes, se recomienda utilizar esta opción baja. Un cojín concreto o los cuadrados concretos del tamaño grande de una piedra del patio se recomiendan para la base conveniente para el suelo. Asegúrese de que sea firme y llana y que permita drenaje lejos del sitio. Hacer una fundación nivel concreto que tiene una dimensión fuera de 129 3/8" x 160 1/2" (3287mm x 4077mm). cobertizo para Básico. **Para una base concreta del cojín, prepare una cama llana para una capa de pie firme de la piedra machacada. El cojín concreto se debe entonces verter a un grueso de 4 pulgadas (100mm) a 5 pulgadas (125mm). Permita secarse a fondo por lo menos 48 horas. El fabricante no es responsable de la opción y de la construcción de la fundación.**
- PT** Para garantir que o seu galpão resiste a ventos fortes, recomendamos usar esta opção de andar. Um bloco de concreto ou um quadrados de pedra de pátio de concreto de tamanho grande é recomendado para base apropriado do assoalho. Certifique-se que é firme e nivelada e permitirá drenagem longe do local. Fazer base de uma fundação de concreto nível, que tem uma dimensão exterior de 129 3/8" x 160 1/2" (3287mm x 4077mm). **Em um bloco de concreto, preparar uma cama de nível para uma camada firme de brita. O base de concreto deve ser derramado em seguida a uma espessura de 4 polegadas (100mm), 5 polegadas (125mm). Deixe para secar completamente pelo menos 48 horas. Fabricante não é responsável pela escolha e construção da Fundação.**
- NL** Om ervoor te zorgen dat uw schuur bestand is tegen hoge winden, raden wij u aan deze vloeroptie te gebruiken. Een concrete pad of een groot formaat concrete patio stenen pleinen wordt aanbevolen voor geschikt woord basis. Zorg ervoor dat het is stevig en niveau en drainage zal toestaan weg van de site. Een niveau concrete stichting, die een externe dimensie van 129 3/8" x 160 1/2" (3287mm x 4077mm). **For a concrete pad base, prepare a level bed for a firm footing layer of crushed stone. The concrete pad should then be poured to a thickness of 4 inches (100mm) to 5 inches (125mm). Allow to dry thoroughly for at least 48 hours. Manufacturer is not responsible for the choice and construction of the foundation.**
- CS** Abyste zajistili, že váš haly odolává silnému větru, doporučujeme použít tuto podlahu. Pro vhodnou podlahovou základnu se doporučuje betonová podložka nebo velké betonové terasové čtverce. Ujistěte se, že je pevný a rovný a umožní odvodnění od místa. Vyrobtte hladký betonový podklad, který má vnější rozměr 129 3/8" x 160 1/2" (3287mm x 4077mm). pro základní shed. **U betonové podložky připravte rovnou lůžko pro pevnou podkladovou vrstvu drčeného kamene. Betonová vložka by měla být nalita do tloušťky od 100 palců do 5 palců (125 milimetrů). Nechte důkladně vyschnout po dobu nejméně 48 hodin. Výrobce nezodpovídá za volbu a výstavbu nadace.**

**SK** Aby ste zabezpečili, že vaša haly odolá vysokému vetru, odporúčame použiť túto podlahovú možnosť.  
Na vhodnú podlahovú základňu sa odporúča betónová podložka alebo veľké betónové terasové kamenné štvorce. Uistite sa, že je pevný a rovný a umožní odvodnenie z miesta. Vytvorte základovú betónovú základ, ktorý má vonkajší rozmer 129 3/8" x 160 1/2"(3287mm x 4077mm), pre základňu. **Pre betónovú podložku pripravte hladkú vrstvu pre pevnú základovú vrstvu drveného kameňa. Betónová podložka by mala byť potom naliata do hrúbky 4 palce (100 mm) až 5 palcov (125 mm). Nechajte dôkladne vysušiť aspoň 48 hodín. Výrobca nie je zodpovedný za výber a výstavbu nadácie.**

**SL** Da bi zagotovili, da bo vaša hiša odtegnila visoke vetrove, smo priporočili, da uporabite to možnost.  
Za primerne talne podlage je priporočljiva betonska podloga ali betonski trgi z velikimi površinami. Prepričajte se, da je čvrsta in raven ter omogočila drenažo stran od mesta. Izdelajte ravno betonsko podlogo, ki ima zunanjo dimenzijo dimenzij 129 3/8" x 160 1/2"(3287mm x 4077mm), za Basic Shed. **Za betonsko podlogo pripravite ravno posteljo za trdno podlogo iz drobljenega kamna. Betonsko ploščo je treba nato vliati do debeline 4 palcev (100 mm) do 5 palcev (125 mm). Pustite, da se temeljito posuši najmanj 48 ur. Proizvajalec ni odgovoren za izbiro in gradnjo temeljev.**

**HR** Da bismo osigurali da vaš prolaz izdrži jak vjetar, preporučujemo da upotrijebite tu podu.  
Za pogodnu podnu bazu preporučuje se betonska podloga ili velike kamene ploče od betona. Pobrinite se da je čvrsta i ravina i omogućit će odvod daleko od stranice. Izradite temeljni betonski temelj koji ima vanjsku dimenziju od 129 3/8" x 160 1/2"(3287mm x 4077mm), za Basic Shed. **Za betonsku podlogu, pripremite krevet na razini za čvrsto podnožje slomljenog kamena. Betonsku podlogu treba zatim izliti na debljinu od 100 mm do 125 inča. Ostavite temeljito suhom najmanje 48 sati. Proizvođač nije odgovoran za odabir i izgradnju zaklade.**

**HU** Annak érdekében, hogy a fészter ellenálljon a magas szeleknek, javasoljuk, hogy használja ezt a padlót.  
Betonpárna vagy nagyméretű betonpadló kőpadok ajánlottak megfelelő padlóalapra. Győződjön meg arról, hogy szilárd és vízszintes, és lehetővé teszi a vízelvezetést távol a helyszíntől. Végezzünk el egy szintetikus alapot, amely 129 3/8" x 160 1/2"(3287mm x 4077mm). Külső méretekkel rendelkezik a Basic Shed számára. **Betonpárnás aljzat esetén készítsen egy szintes ágyat egy szilárd alapozórétre. A betonpárnát ezután 100 mm-es és 125 mm-es vastagságúra kell önteni. Legalább 48 órán keresztül hagyja alaposan száradni. A gyártó nem vállal felelősséget az alapítvány kiválasztásához és megépítéséért.**

**SV** För att säkerställa att din skjul tål hög vind rekommenderar vi att du använder det här golvalternativet.  
En betongkudde eller en stor betongplattform stenplattor rekommenderas för lämplig golvyta. Se till att den är fast och jämn och gör det möjligt att dränera bort från platsen. Gör en jämn betongfundament, som har en yttre dimension av 129 3/8" x 160 1/2"(3287mm x 4077mm), för Basic Shed. **För en betongplatta bas, förbereda en nivå säng för ett fast fotskikt av krossad sten. Betongplattan ska sedan hållas till en tjocklek av 4 tum (100 mm) till 5 tum (125 mm). Låt torka noggrant i minst 48 timmar. Tillverkaren ansvarar inte för valet och bygandet av stiftelsen.**

**IT** Per garantire che il tuo capannone sopporta venti elevati, abbiamo consigliato di utilizzare questa opzione a pavimento.  
Si consiglia un tappetino in calcestruzzo o un quadrato in pietra di cemento in grande formato per una base adatta. Assicurarsi che sia stabile e livellato e permetterebbe di drenare lontano dal sito. Realizzare una base di calcestruzzo di livello, che ha una dimensione esterna di 129 3/8" x 160 1/2"(3287mm x 4077mm), per Basic Shed. **Per una base di rilievo in calcestruzzo, preparare un letto a livello per un solido strato di pietra schiacciata. Il tappetino di calcestruzzo deve quindi essere versato ad uno spessore da 100 mm a 125 centimetri. Lasciare asciugare accuratamente per almeno 48 ore. Il produttore non è responsabile della scelta e della costruzione della fondazione.**

**PL** W celu zapewnienia, że szopy wytrzymują wysokie wiatry, zalecamy skorzystanie z tej opcji podłogi.  
Betonu pad lub duży rozmiar konkretne patio kamień kwadratów jest zalecane dla odpowiedniej bazy piętro. Upewnij się, że to jest prosto i stabilnie i pozwoli drenaż wiatryny. Zrobić fundamentie betonowym poziom, który ma wymiar zewnętrzny 129 3/8" x 160 1/2"(3287mm x 4077mm).. **Do betonu pad podstawy, przygotować łóżko poziom dla firmy stopie warstwę tłucznia. Betonu pad powinien być następnie przelewa się do grubości 4 cali (100mm) do 5 cali (125mm). Pozostawić do wyschnięcia dokładnie na co najmniej 48 godzin. Producent nie jest odpowiedzialny za wybór i budowie fundamentów.**

**RO** Pentru a vă asigura că vaporul dvs. rezistă unor vânturi puternice, am recomandat să folosiți această opțiune pentru podea.  
Un tampon de beton sau o pătrată de piatră din beton de dimensiuni mari este recomandată pentru o bază adecvată pentru podea. Asigurați-vă că este ferm și la nivel și va permite scurgerea departe de site. Asigurați o fundație de beton de nivel, care are o dimensiune exterioră de 129 3/8" x 160 1/2"(3287mm x 4077mm), pentru Shed Basic. **Pentru o bază de bază de beton, pregătiți un pat de nivel pentru un strat ferm de piatră zdrobită. Plăcuța de beton trebuie apoi turnată la o grosime de 4 inci (100 mm) până la 5 inci (125 mm). Lăsați-l să se usuce bine timp de cel puțin 48 de ore. Producătorul nu este responsabil pentru alegerea și construirea fundației.**

**BG** За да сте сигурни, че Вашата барака издържа високи ветрове, препоръчваме да използвате тази опция за пода.  
За подходяща подова основа се препоръчва използването на бетонна подложка или големи бетонни квадратни плочки. Уверете се, че тя е здрава и равна и ще позволи дренаж далеч от мястото. Направете нивелирана бетонна основа, която има външен размер от 129 3/8" x 160 1/2"(3287mm x 4077mm), за основен навес. **За бетон основа на подложка, подгответе ниво легло за твърда основа слой от натрошен камък. След това бетонната подложка трябва да се излива на дебелина от 4 инча (100 mm) до 5 инча (125 mm). Оставете да изсъхне напълно за поне 48 часа. Производителят не носи отговорност за избора и изграждането на основата.**

**TR** Sunduğunuzdan yüksek rüzgarlara dayanıklı olmasını sağlamak için bu zemin seçeneğini kullanmanızı öneririz.  
Uygun taban tabanı için beton bir yastık veya büyük boy bir beton bahçe avlusu karosu önerilir. Sert ve sağlam olduğundan ve drenajın yerinden uzaklaşmasına izin vereceğinden emin olun. Basic Shed için dış boyut 129 3/8" x 160 1/2"(3287mm x 4077mm), olan düz bir beton temel oluşturun. **Beton pad taban için, ezilmiş taştan sağlam bir taban tabakası için düz bir yatak hazırlayın. Beton pedi daha sonra 4 inç (100mm) ila 5 inç (125mm) arasındaki bir kalınlığa dökülmelidir. En az 48 saat boyunca iyice kurummasına izin verin. Üretici, vakfın seçimi ve yapımı için sorumlu değildir.**





F1 (x26)



S2 (x26)

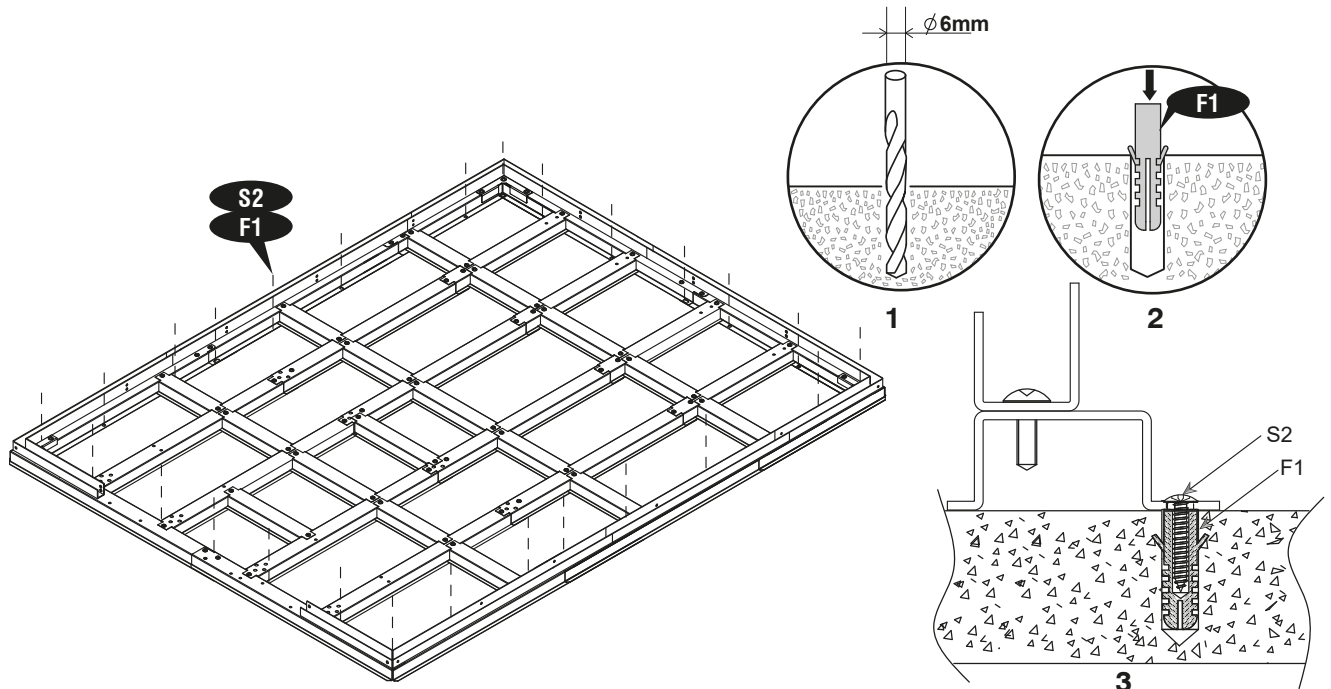

EN Floor Options

FR Option plancher

DE Bedenoptionen

ES Opción de piso

PT Opções de piso

NL Betonnen plaat

CS Možnosti podlahy

SK Možnosti podlahové

SL Možnosti tal

HR Kat Mogućnosti

HU Padlóbeállítások

SV Golvalternativ

IT Opzioni del pavimento

PL Opcje podłogowe

RO Opțiuni de podea

BG Подови опции

TR Yer Seçenekleri

EN Plywood (Not included)

FR Contreplaqué (non inclus)

DE Sperrholz (Nicht enthalten)

ES Contrachapado (No incluido)

PT Contraplacado (não incluido)

NL Multiplex (niet inbegrepen)

CS Přecližka (není součástí balení)

SK Preglejška (nie je súčasťou balenia)

SL Vezane plošče (niso vključene)

HR Šperploča (nije uključeno)

HU Rétegelt lemez (nem tartozék)

SV Plywood (ingår ej)

IT Compensato (non incluso)

PL Sklejka (nie wliczone)

RO Placaj (Nu este inclus)

BG Шперплат (не е включен)

TR Kontrplak (dahil değildir)

1



EN Place the Exterior Grade (CDX) - 3/4" (19mm) Weather proof Marine grade plywood on top of the foundation.

FR Placer le grade extérieur (CDX) - 3/4 "(19mm) résistante aux intempéries de contreplaqué de qualité marine au-dessus de la fondation.

DE Legen Sie das wetterbeständige Marine Grade Sperrholz (CDX) - 3/4"(19 mm) auf die Oberseite des Fundaments.

ES Coloque el grado exterior (CDX) - 3/4 "(19 mm) resistente a la intemperie contrachapado marino de grado en la parte superior de la fundación.

PT Coloque o Exterior Grau (CDX) - 3/4 "(19mm) Contraplacado marítimo à prova de intempéries no topo da fundação.

NL Place the Exterior Grade (CDX) - 3/4" (19mm) Weather proof Marine grade plywood on top of the foundation.

CS Umístěte vnější použití (CDX) - 3/4" (19 mm), odolná vůči povětrnostním vlivům mořské stupeň přecližky na vrcholu základu.

- SK** Umiestnite vonkajšie použitie (CDX) - 3/4 "(19 mm), odolná voči poveternostným vplyvom morskej stupeň preglejky na vrchole základu.
- SL** Postavite Zunanjost razred (CDX) - 3/4 "(19mm) Vreme dokaz Marine stopnje vezan na vrhu temelja.
- HR** Postavite vanjsku površinu (CDX) - 3/4 "(19 mm) morsku ploču s obloženom vremenskom zaštitom na vrhu temelja.
- HU** Helyezzük el a külső minőséű (CDX) - 3/4 "(19 mm) időjárásálló minőséű tengeri rétegelt lemezt az alapzat tetején.
- SV** Placera yttre graden (CDX) - 3/4 "(19mm) Vädret bevis Marine grade plywood ovanpå fundamentet.
- IT** Collocare il compensato di grado marino per esterni (CDX) - 3/4 "(19mm) sopra la fondazione.
- PL** Umieść wodoodporną sklejkę klasy morskiej (CDX) - 3/4 "(19 mm) odporną na warunki atmosferyczne na fundamencie
- RO** Așezați placa de calitate exterioară (CDX) - placaj de calitate maritimă de 3/4 "(19mm) pe fundul fundației.
- BG** Поставете външния клас (CDX) - 3/4 "(19 мм) Влагоустойчив шперплат от морски клас върху основата.
- TR** Dış Tabanı (CDX) - 3/4 "(19mm) Hava şartlarına dayanıklı Deniz sınıfı kontrplakı, temelin üstüne yerleştirin.

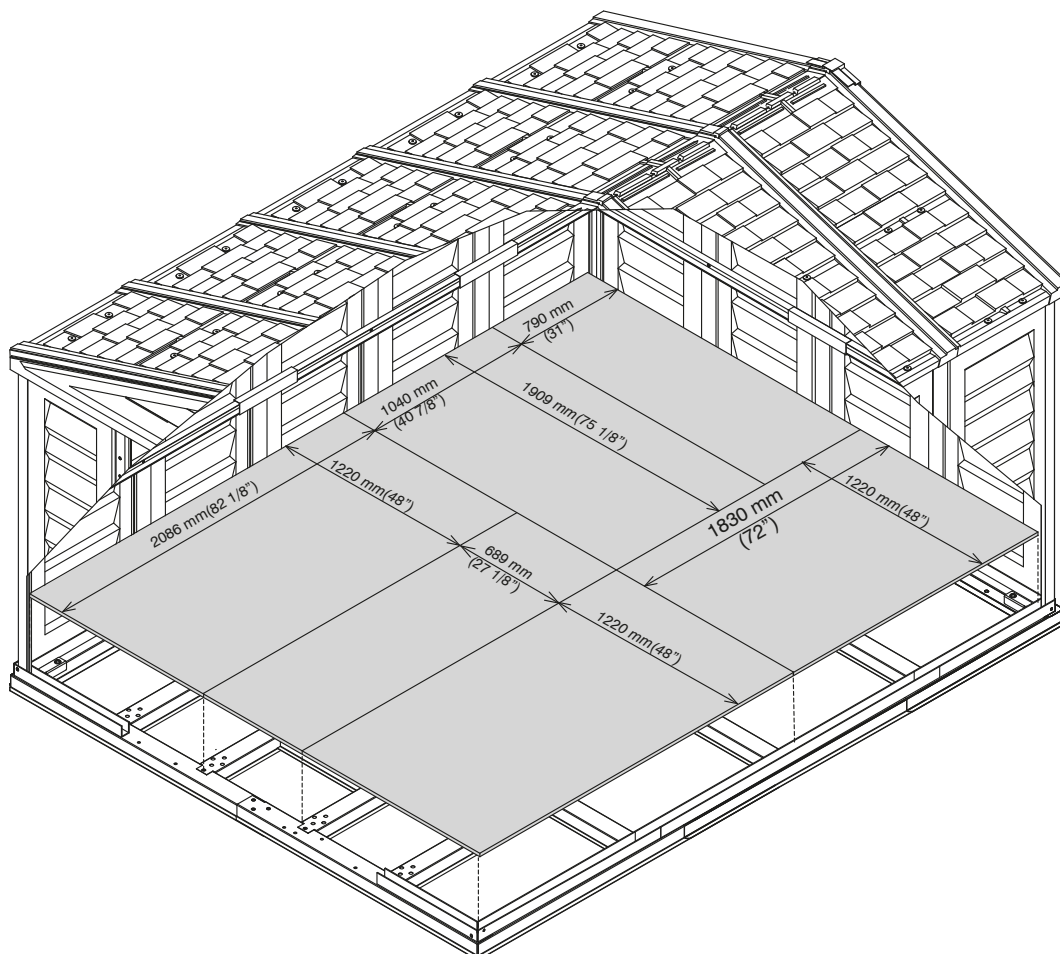



EN Concrete Floor (Not included)	CS Betonová podlaha (není součástí balení)	IT Pavimento in cemento (non incluso)
FR Plancher de béton (non inclus)	SK Betónová podlaha (nie je súčasťou balenia)	PL Podłoga betonowa (nie wliczone)
DE Betonboden (Nicht enthalten)	SL Betonska tla (niso vključene)	RO Podea din beton (nu este inclusă)
ES Piso de concreto (No incluido)	HR Betonski kat (nije uključen)	BG Бетонни подове (не са включени)
PT Piso de concreto (não incluído)	HU Betonpadló (nem tartozék)	TR Beton Zemin (dahil değildir)
NL Betonnen vloer (niet inbegrepen)	SV Betonggolv (ingår ej)	

2

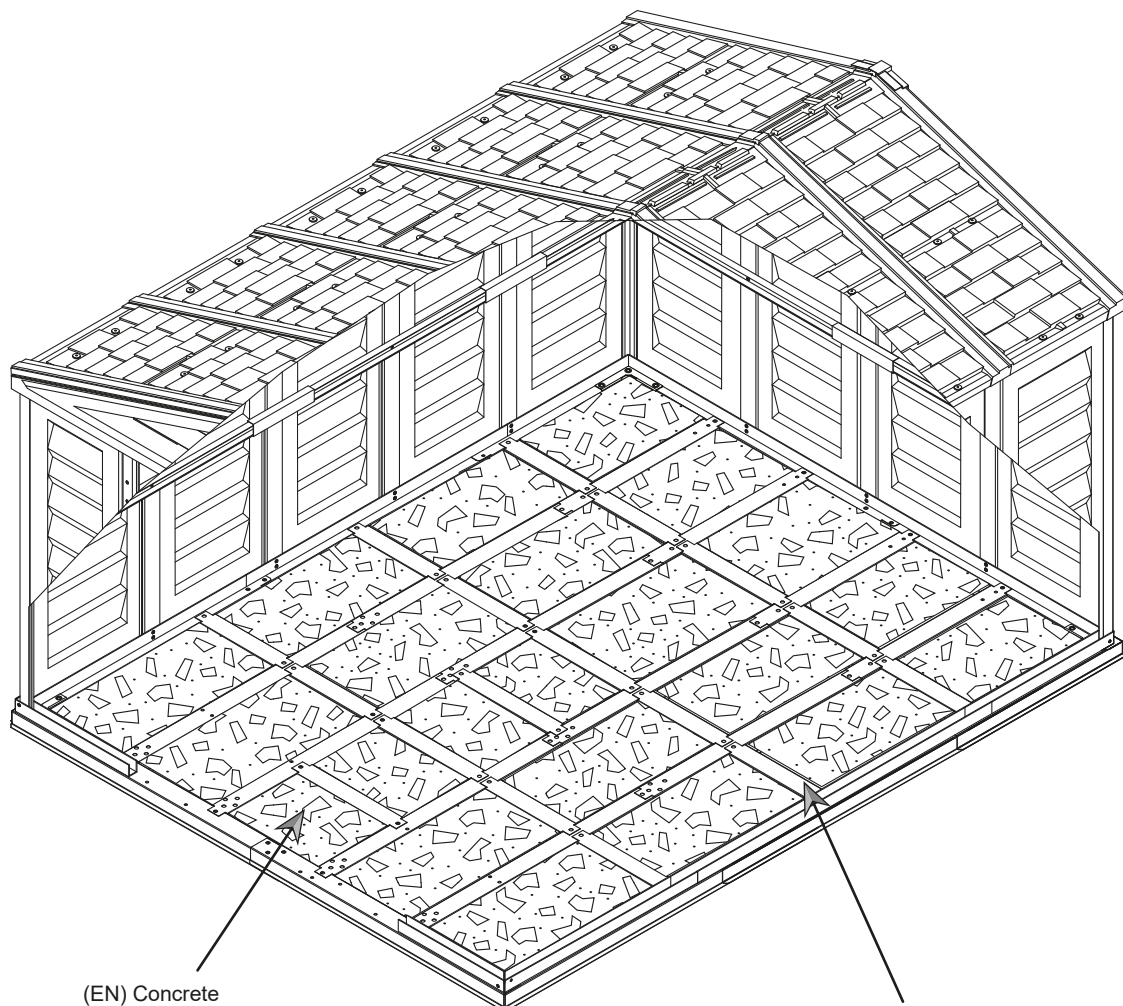

(EN) Concrete  
(FR) Béton  
(DE) Beton  
(ES) Hormigón  
(PT) Concreto  
(NL) Beton  
(CS) Beton  
(SK) Beton  
(SL) Beton  
(HR) Beton  
(HU) Konkrét  
(SV) Betong  
(IT) Calcestruzzo  
(PL) Beton  
(RO) Beton  
(BG) бетон  
(TR) Beton

(EN) Concrete to be filled up to this level  
(FR) Béton à remplir à ce niveau  
(DE) Beton, der bis zu dieser Ebene gefüllt werden muss  
(ES) Concreto para ser llenado hasta este nivel  
(PT) Concreto a ser preenchido até este nível  
(NL) Beton dat tot dit niveau moet worden opgevuld  
(CS) Beton, který se má naplnit do této úrovně  
(SK) Betón, ktorý sa má naplniť do tejto úrovne  
(SL) Beton, ki ga je treba napolniti do te stopnje  
(HR) Beton koji treba popuniti na ovu razinu  
(HU) Beton kell tölteni ezt a szintet  
(SV) Betong fylls upp till denna nivå  
(IT) Calcestruzzo da riempire fino a questo livello  
(PL) Beton do wypełnienia do tego poziomu  
(RO) Beton care trebuie umplut până la acest nivel  
(BG) Бетонът трябва да се запълни до това ниво  
(TR) Bu seviyeye kadar doldurulacak beton





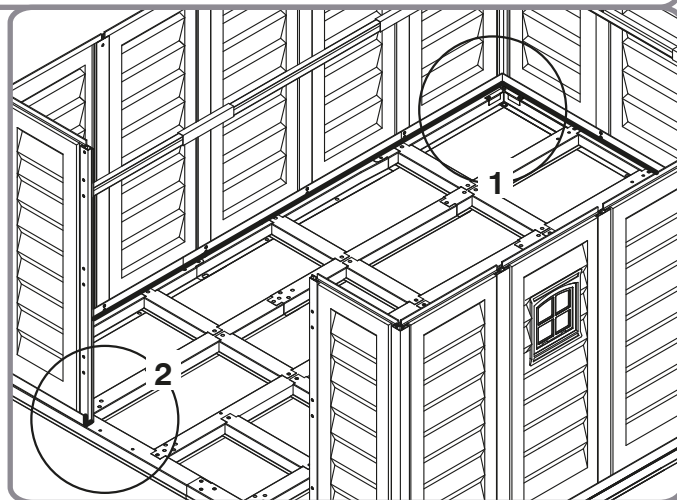
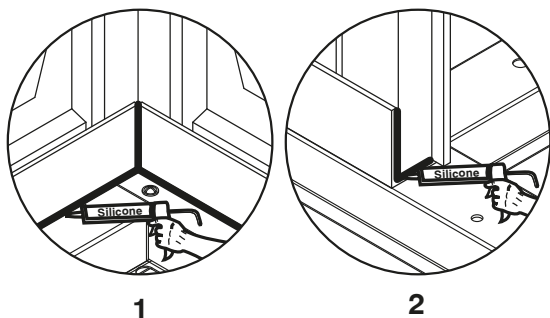

- EN** Apply silicone around the perimeter of the base 'U' channel. Seal the corners, joints and base of door column. This is optional and should be done for heavy rain areas if needed.
- FR** Appliquez de la silicone sur le pourtour du canal de 'U' de la base. Scellez les coins, les joints et la base de la colonne de la porte. Cette étape est facultative et devrait se faire pour les zones de fortes pluies, si nécessaire.
- DE** Geben Sie Silikon um den Umfang des Basis 'U' Kanals. Verschließen Sie die Ecken, Fugen und die Basis der Türspalte. Dies ist optional und sollte für starke Regenbereiche getan werden, wenn nötig.
- ES** Aplicar silicona alrededor del perímetro del canal "U" de la base. Selle las esquinas, juntas y la base de la columna de la puerta. Esto es opcional y se debe hacer para zonas de fuertes lluvias, si es necesario.
- PT** Aplique silicone ao redor do perímetro da Base de Canal 'U'. Isole os cantos, juntas e a base da coluna da porta. Isto é opcional e deve ser feito apenas em áreas chuvosas, se necessário.
- NL** Breng de silicone rond de omtrek van het kanaal de basis "U". Dicht de hoeken, gewrichten en de basis van de deur kolom. Dit is optioneel en moet gedaan worden voor zware regenval gebieden indien nodig.
- CS** Aplikujte silikon kolem obvodu základního "U" kAnálu. Uzavřete rohy, spoje a základnu dveří sloupce. Tato možnost je volitelná a je jí potřeba v případě potřeby udělat v oblastech se silným větrem.
- SK** Použite silikón okolo obvodu základného kanálu "U". Utesnite rohy, spoje a základňu dverného stĺpika. Toto je voliteľné a malo by sa v prípade potreby urobiť pre silné dažďové oblasti.
- SL** Nanesite silikon okrog oboda podlage 'U' kanala. Zapečatite robove, sklepe in osnove vratnega stebra. Je neobvezno, vendar je to priporočljivo storiti za področja z veliko padavinami in če je to potrebno.
- HR** Nanesite silikon oko perimetra baznog "U" kanala. Brtviti kutove, zglobove i podnožje stupova vrata. Ovo je neobavezno i trebalo bi biti učinjeno za teške kiše ako je potrebno.
- HU** Szilikonot alkalmazzon az alap "U" csatorna peremén. Tömítse be az ajtóoszlop sarkait, csuklóit és alapját. Ez opcionális, és szükség esetén a nehéz esőterületekre is meg kell történnie.
- SV** Applicera silikon runt omkretsens U-kanal. Försegla hörnen, lederna och basen av dörrkolonnen. Detta är valfritt och bör göras för tunga regnområden om det behövs.
- IT** Applicare silicone attorno al perimetro del canale 'U' di base. Sigillare gli angoli, i giunti e la base della colonna della porta. Questo è opzionale e dovrebbe essere fatto per le zone di pioggia pesante, se necessario.
- PL** Zastosuj silikon wokół obwodu podstawowego kanału "U". Uszczelnij rogi, złącza i podstawę kolumny drzwi. Jest to opcjonalne i powinno być wykonane w przypadku intensywnych opadów deszczu w razie potrzeby.
- RO** Aplicați silicon în jurul perimetrului canalului de bază "U". Sigilați colțurile, îmbinările și baza coloanei ușii. Acest lucru este opțional și ar trebui făcut pentru zonele cu ploi abundente dacă este necesar.
- BG** Нанесете силикон около периметъра на базовия канал "U". Запечатайте ъглите, ставите и основата на колоната на вратите. Това е по избор и трябва да се направи за тежки дъждове, ако е необходимо.
- TR** Baz 'U' kanalının çevresine silikon uygulayın. Kapı kolonunun köşelerini, bağlantılarını ve tabanını kapatın. Bu isteğe bağlıdır ve gerektiğinde şiddetli yağmur alanları için yapılmalıdır.



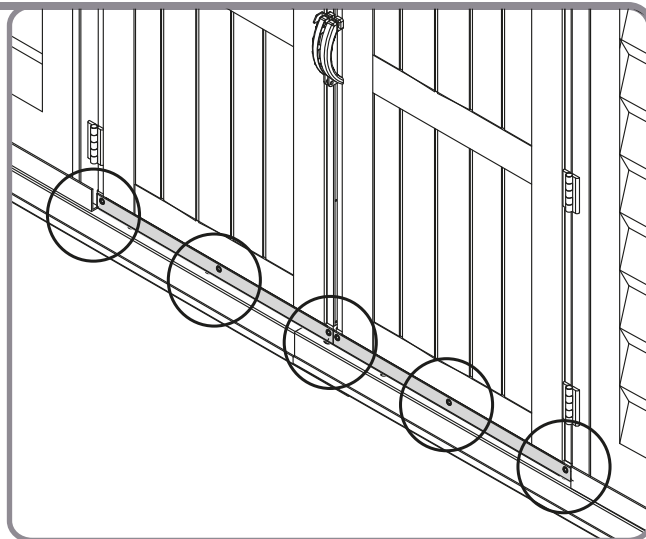
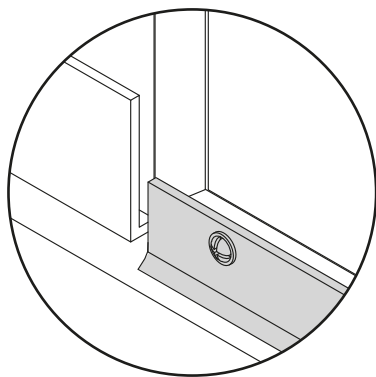

**EN** For heavy rain areas, you can fix a weather strip at the bottom of the door. This is optional and the part is not included.

**FR** Pour les zones de fortes pluies, vous pouvez fixer un coupe-froid au bas de la porte. Cette étape est facultative et la partie n'est pas incluse.

**DE** Für starke Regenbereiche können Sie einen Dichtungsstreifen an der Unterseite der Tür befestigen. Dies ist optional und das Teil ist nicht enthalten.

**ES** En las zonas de fuertes lluvias, se puede fijar un burlete en la parte inferior de la puerta. Esto es opcional y la pieza no está incluida.

**PT** Para áreas chuvosas, você pode fixar uma Fita Impermeável na soleira da porta. Isto é opcional e a parte não é inclusa

**NL** Voor zware regengebieden, kunt een tochtstrip vastzetten aan de onderkant van de deur. Dit is optioneel en de onderdeel niet inbegrepen.

**CS** V oblastech se silným deštěm můžete upevnit povětrnostní pás v dolní části dveří. Tato možnost je volitelná a část se nezahrnuje.

**SK** Pre silné dažďové oblasti môžete v spodnej časti dverí umiestniť pás. Toto je voliteľné a časť nie je zahrnutá.

**SL** Za področja z veliko padavinami se lahko namesti tudi vremenski tesnilni trak, na spodnji del vrat. To je neobvezno in sestavni del ni priložen.

**HR** Za područja s jakim kišama, možete pričvrstiti vremensku traku na dnu vrata. Ovo je neobavezno i dio koji nije uključen.

**HU** Nagy esőterületek esetén az ajtó alján egy időjárásí sávot rögzíthet. Ez opcionális és a nem tartalmazza.

**SV** För tunga regnområden kan du få en väderremsa längst ner på dörren. Detta är valfritt och delen ingår ej.

**IT** Per le zone con piogge abbondanti, è possibile fissare una fascia meteorologica nella parte inferiore della porta. Questo è opzionale e la parte non è inclusa.

**PL** Zastosuj silikon wokół obwodu podstawowego kanału "U". Uszczelnij rogi, złącza i podstawę kolumny drzwi. Jest to opcjonalne i powinno być wykonane w przypadku intensywnych opadów deszczu w razie potrzeby.

**RO** Pentru zonele cu ploi abundente, puteți găsi o bandă de vreme în partea de jos a ușii. Acest lucru este opțional și partea nu este inclusă.

**BG** За тежки дъждовни зони можете да поставите лента за времето в долната част на вратата. Това е по избор и частта не е включена.

**TR** Şiddetli yağmur bölgeleri için, kapının altında bir hava şeridi oluşturabilirsiniz. Bu isteğe bağlıdır ve dahil olmayan kısım.



EN High wind area installation instructions	HR Visoke instalacije za instalaciju vjetra
FR Instructions pour une installation dans des zones de vent violent	HU Magas szélterületi szerelési útmutató
DE Starke Windbereiche Installationsanweisungen	SV Installationsanvisningar för hög vindområde
ES Instrucciones de instalación de la zona con fuertes vientos	IT Istruzioni per l'installazione dell'area vento forte
PT nstruções de Instalação para Áreas de Ventos Fortes	PL Instrukcja instalacji w obszarze wysokiego wiatru
NL Harde wind gebied installatie instructies	RO Instrucțiuni de instalare a zonelor eoliene
CS Instalační souprava pro oblasti se silným větrem	BG Високи инструкции за инсталиране на вятърна
SK Veľké pokyny na inštaláciu vetra	TR Yüksek rüzgar alanı kurulum talimatları
SL Navodila za montažo za območja z močnimi vetrovi	



- EN To ensure that your shed withstands high winds, you will need the following reinforcement.
- FR Pour être sûr que votre abri supportera des vents violents, vous devrez vous équiper des renforts suivants
- DE Um sicherzustellen, dass Ihr Schuppen starken Wind standhält, brauchen Sie die folgende Verstärkung.
- ES Para asegurarse de que su cubierta resiste a vientos fuertes, se necesita el siguiente refuerzo.
- PT Para garantir que seu galpão resista a ventos fortes, você precisará do seguinte reforço.
- NL Om ervoor te zorgen dat uw schuur bestand is tegen harde wind, heeft u de volgende versterking nodig.
- CS Aby bylo zajištěno, že vaše bouda odolává silnému větru, budete potřebovat následující vyztužení.
- SK Aby ste zabezpečili, že vaša haly odolá vysokým vetrom, budete potrebovať nasledovné zosilnenie.
- SL Da bi zagotovili, da bo vaša hiša trajala z močnim vetrom, boste potrebovali naslednjo ojačitev.
- HR Da bi se osiguralo da vaš prolaz izdrži jak vjetar, trebat će vam sljedeće pojačanje.
- HU Annak biztosítására, hogy a fészer ellenálljon a magas szeleknek, a következő megerősítésre lesz szüksége.
- SV För att säkerställa att dina skjul tål höga vindar behöver du följande förstärkning.
- IT Per garantire che il tuo capannone resista a forti venti, avrai bisogno del seguente rinforzo.
- PL Aby upewnić się, że twoja szopa wytrzyma silne wiatry, będziesz potrzebować następującego wzmocnienia.
- RO Pentru a vă asigura că vaporul dvs. rezistă la vânturi puternice, veți avea nevoie de armarea următoare.
- BG За да сте сигурни, че вашата барака издържа високи ветрове, ще ви трябва следната подсилване.
- TR Kulübünüzün yüksek rüzgarlara dayanmasını sağlamak için, aşağıdaki takviyeye ihtiyacınız olacaktır.



EN Parts needed (Not included)	CS Potřebné součásti (není součástí balení)	IT Parti occorrenti (non incluso)
FR Pièces nécessaires (non inclus)	SK Potrebne časti (nie je súčasťou balenia)	PL Niezbędne elementy (nie wliczone)
DE Benötigte Teile (Nicht enthalten)	SL Potrebni deli (niso vključene)	RO Elementele componente necesare (Nu este inclus)
ES Las partes necesarias (No incluido)	HR Dijelovi potreban (nije uključeno)	BG Необходими части (не е включен)
PT Peças Necessárias (não incluído)	HU Szükséges részek (nem tartozék)	TR Gerekl parçalar (dahil değildir)
NL Onderdelen nodig (niet inbegrepen)	SV Delar som behövs (ingår ej)	

S4 Dia. 4.2 x 16mm. (5/32" x 5/8") 64





**EN** To ensure that your shed will withstand high winds, you need to anchor on the concrete foundation. Align the shed, mark the concrete at the holes in the Foundation Profiles and drill concrete with suitable concrete bit to accept Dia 6mm wall plug. (Follow the assembly step in page 69-71).

**FR** Pour vous assurer que votre hangar va résister aux vents violents, il fallait ancrer sur la foundation. Aligner béton du hangar, marquer le béton au niveau des trous dans les profils de fondation et forage de béton avec foret à béton adapté à accepter diamètre prise murale de 6 mm. (Suivez l'étape d'assemblage en pages 69-71).

**DE** Um sicherzustellen, dass Ihr Schuppen starken Winden widerstehen kann, müssen Sie auf dem Betonfundament verankern. Richten Sie den Schuppen aus, markieren Sie den Beton an den Löchern in den Fundamentprofilen und bohren Sie Beton mit geeignetem Betonstück, um den 6 mm Wanddübel zu akzeptieren. (Folgen Sie dem Montageschritt auf Seite 69-71).

**ES** Para asegurarse de que su nave puede soportar fuertes vientos, lo necesario para anclar en el concreto foundation. Align el cobertizo, marcar el hormigón en los agujeros de los perfiles de cimentación y perforación de hormigón con hormigón poco adecuada para aceptar el enchufe de pared de diámetro 6 mm. (Sigue la etapa de montaje en la página 69-71).

**PT** Para garantir que seu galpão irá suportar ventos fortes, você precisa ancorar na fundação de concreto. Alinhe o galpão, marque o concreto nos orifícios dos perfis de fundação e perfure o concreto com o bit de concreto adequado para aceitar o plugue de parede de diâmetro de 6 mm. (Siga o passo de montagem na página 69-71)

**NL** Om ervoor te zorgen dat uw schuur bestand is tegen harde wind, moet u op de betonnen fundering steunen. Lijn de schuur uit, markeer het beton op de gaten in de funderingsprofielen en boor beton met een geschikte betonstaal om de 6 mm-muurplug van Dia te bevestigen. (Volg de montage stap op pagina 69-71).

**CS** Aby bylo zajištěno, že vaše bouda odolá vysokým větrům, je třeba kotvit na betonovém podkladu. Připojte kůlnu, vyznačte beton v dírách v profilech základové vrstvy a vrtáním betonu vhodným betonovým břittem, abyste přijali zásuvku se zásuvkou Dia 6mm. (Postupujte podle kroku sestavení na straně 69-71).

**SK** Aby ste zabezpečili, že vaša budova bude odolávať vysokému vetru, musíte zakotviť na betónovom podklade. Pripevniť kôlnu, označiť betón v otvoroch základových profilov a vyvrtávať betón s vhodným betónovým bičom, aby ste prijímali nástennú zátku Dia 6 mm. (Postupujte podľa kroku montáže na strane 69-71).

**SL** Da bi zagotovili, da bo vaša hiša vzdržala visoke vetrove, morate sidrati na betonskem temelju. Potegnite vrelo, označite beton na luknjah v temeljnih profilih in izvrtajte beton z ustreznim betonom, da sprejmete vtičnico Dia 6mm. (Sledite korak montaže na strani 69-71).

**HR** Kako bi se osiguralo da će vaš prolaz izdržati visoke vjetrove, morate se sidriti na betonskoj podlozi. Pričvrstite prolivenu ploču, označite beton na rupama u profilima podloge i izbušite beton s odgovarajućim betonskim zupčanjem da biste prihvatili zidni utikač Dia 6 mm. (Slijedite korak montaže na stranici 69-71).

**HU** Annak érdekében, hogy a fészer ellenálljon a magas szélnek, meg kell horgonni a beton alapon. Align a fészer, jelölje a beton az lyukak az alapítványi profilok és fúrni beton megfelelő beton bit elfogadni Dia 6 mm-es fali dugó. (Kövesse a szerelési lépést az 69-71 oldalon).

**SV** För att säkerställa att ditt skjul tål höga vindar, måste du ankra på betongfundamentet. Passa skuren, markera betongen i hålen i stiftprofilerna och borra betong med lämplig betongbit för att ta emot Dia 6mm väggkontakt. (Följ monteringssteget på sidan 69-71).

**IT** Per garantire che il tuo capannone resista a forti venti, è necessario ancorare sulle fondamenta in calcestruzzo. Allineare il capannone, contrassegnare il cemento nei fori dei profili di fondazione e forare il calcestruzzo con una punta di cemento adatta per accettare il tappo a muro da 6 mm. (Seguire la fase di assemblaggio a pagina 69-71).

**PL** Aby upewnić się, że twoja buda wytrzyma silne wiatry, musisz zakotwiczyć na betonowym fundamencie. Wyrównać budę, oznaczyć beton w otworach w profilach fundamentowych i wywiercić beton za pomocą odpowiedniego wiertła do betonu, aby zaakceptować korek ścienny Dia 6 mm. krok montażu na stronie 69-71).

**RO** Pentru a vă asigura că vaporul dvs. va rezista la vânturi puternice, trebuie să vă ancorați pe fundația de beton. Alinați șopronul, marcați betonul în găurile din Profilele de fundație și forțați betonul cu un șurub de beton adecvat pentru a acționa fișa de perete Dia 6mm. (Urmați pașii de asamblare de la pagina 69-71).

**BG** За да сте сигурни, че вашата барака ще издържи на силни ветрове, трябва да закрепите на бетонната основа. Направете заграждението, маркирайте бетона в отворите в профилите на основата и пробийте бетон с подходящ бетон, за да приемете 6 мм стена. (Следвайте стъпката за монтаж на стр. 69-71).

**TR** Kulübünüzün yüksek rüzgara dayanacağından emin olmak için, beton temel üzerine demirlemeniz gerekir. Döşemeyi hizalayın, Beton Temel Profillerdeki deliklerden işaretleyin ve Dia 6mm duvar fişini kabul etmek için betonu uygun bir beton ile delin. (Sayfa 69-71 'teki montaj adımı izleyin).

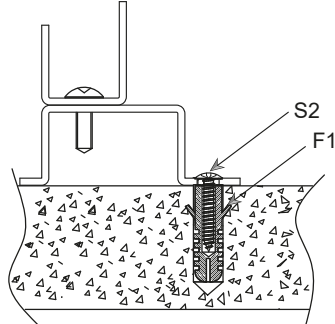





- EN** Attach each side panel (WPA1↑,WPA2↑) on the bottom to the Base U-channel. Using a dia. 3mm (1/8") drill with a power drill, make two equal distance holes on the Base U-channel through the Side Panel. Drive a self tapping screw(S4) through the Base U-channel to the Side Panel. Repeat this for every Side Panel. See blowup.
- FR** Attachez chaque panneau latéral (WPA1↑,WPA2↑) sur le bas des profilés U . En utilisant un foret de 3mm de dia. avec une perceuse électrique, faites deux trous à à égale distance sur le profilé U , à travers le Panneau Latéral. Enfoncez une vis auto-fôrante(S4) à travers le profilé U au Panneau Latéral. Répétez ceci pour chaque panneau latéral. Voir schéma ci-dessous.
- DE** Befestigen Sie jedes Seitenteil (WPA1↑,WPA2↑) auf dem Boden an der Basis des U-Kanals. Mit einem 3mm (1/8 ") Diameter Bohrer mit einer Bohrmaschine, machen Sie zwei Löcher im gleichen Abstand auf der Basis des U-Kanals durch das Seitenteil. Geben Sie eine Blechschraube (S4) durch dem Basis U-Kanal in dem Seitenteil. Wiederholen Sie diesen Vorgang für jedes Seitenteil. Siehe Vergrößerung.
- ES** Fije cada panel lateral (WPA1↑,WPA2↑) en la parte inferior a la base U-canal. Usando un día. 3 mm (1/8 ") perfore con un taladro eléctrico, hacer dos agujeros a la misma distancia de la Base del canal U- a través del panel lateral. Introduzca un tornillo auto-roscante (S4) a través de la Base de canal U- del panel lateral. Repita esto para cada panel lateral.Ver ampliación.
- PT** Anexe cada painel lateral (WPA1↑,WPA2↑) na parte inferior ao canal U base. Usando um dia. Broca de 3 mm (1/8 ") com uma furadeira elétrica, faça dois furos de igual distância no canal U base através do painel lateral. Conduza um parafuso auto-roscante (S4) através do canal U base para o painel lateral. Repita isso para cada painel lateral. Veja a explosão.
- NL** Bevestig elk zijpaneel (WPA1↑,WPA2↑) aan de onderkant aan het Base U-kanaal. Een dia gebruiken 3 mm (1/8 ") boor met een boormachine, maak twee gaten van gelijke afstand op het U-kanaal van de basis via het zijpaneel. Draai een zelftappende schroef (S4) door het basis U-kanaal naar het zijpaneel. Herhaal dit voor elk zijpaneel. Zie blowup.
- CS** Připojte každý boční panel (WPA1↑,WPA2↑) na spodní straně základního U-kanálu. Pomocí dia. Vrtačka 3 mm (1/8 ") s vrtacím vrtacím zařízením vytváří dva rovných vzdáleností otvorů na základním U-kanálu přes boční panel. Projděte samočinný šroub (S4) přes kanál U základny k bočnímu panelu. Opakujte to pro každý boční panel. Podívejte se na foukání.
- SK** Pripojte každý bočný panel (WPA1↑,WPA2↑) na spodnej strane základňového U-kanálu. Pomocou dia. Vŕtačka 3 mm (1/8 ") s výkonným vŕtákom vytvára dva rovnakých vzdialeností otvorov na základnom U-kanáli cez bočný panel. Posuňte samočinnú skrutku (S4) cez základný U-kanál na bočný panel. Zopakujte to pre každý bočný panel. Pozri fúkanie.
- SL** Vsako stransko ploščo (WPA1↑,WPA2↑) pritrdite na dno na osnovni U-kanal. Uporaba dia. 3mm (1/8 ") vrtanje z napravo za vrtanje, naredite dva odprtini za enako razdaljo na osnovnem U-kanalu skozi stransko ploščo. Vozite samopropustni vijak (S4) skozi osnovni U-kanal do bočne plošče. To ponovite za vsako stransko ploščo. Glej blowup.
- HR** Pričvrstite svaku bočnu ploču (WPA1↑,WPA2↑) na dno na osnovni U-kanal. Korištenje dijaprojeksije. 3 mm (1/8 ") bušilica s bušilicom za snagu, postavite dva otvora na jednaku udaljenost na osnovnom U-kanalu kroz bočnu ploču. Vozite vijak za samolijepljivanje (S4) kroz osnovni U-kanal na bočnu ploču. Ponovite ovo za svaku bočnu ploču. Pogledajte blowup.
- HU** Csatlakoztassa az egyes oldalpanelet (WPA1↑,WPA2↑) az alsó részhez az alap U-csatornához. Dia. 3 mm-es (1/8 ") fúrógépet fúrval, tegyen kettő egyenlő távolságot az alap U-csatornán az oldallapon keresztül. Vezessen egy öncsapot (S4) az alap U-csatornán keresztül az oldalsó panelre. Ezt ismétélje meg minden oldallaphoz. Lásd a fűjást.
- SV** Fäst varje sidopanel (WPA1↑,WPA2↑) på botten till bas U-kanalen. Använda en bild 3 mm (1/8 ") borrh med en kraftborr, gör två lika distanshål på bas U-kanalen genom sidopanelen. Kör en självtagsskruv (S4) genom bas U-kanalen till sidopanelen. Upprepa detta för varje sidopanel. Se upplåsning.
- IT** Attaccare ciascun pannello laterale (WPA1↑,WPA2↑) sul fondo al canale U di base. Utilizzando un dia. Trapano da 3mm (1/8 ") con trapano elettrico, realizzare Due fori di uguale distanza sul canale U di base attraverso il pannello laterale. Guidare una vite autofilettante (S4) attraverso il canale U di base sul pannello laterale. Ripeti questo per ogni pannello laterale. Vedi l'ingrandimento.
- PL** Przymocuj każdy panel boczny (WPA1↑,WPA2↑) na spodzie do podstawowego kanału U.Korzystanie z dia. Wiertło o średnicy 3 mm (1/8 cala) z wiertarką mechaniczną, wykonaj dwa równych otworów na podstawie w kanale U poprzez panel boczny. Wkręć śrubę samogwintującą (S4) przez podstawowy kanał U do panelu bocznego. Powtórz to dla każdego panelu bocznego. Zobacz blowup.
- RO** Ataşați fiecare panou lateral (WPA1↑,WPA2↑) în partea inferioară către canalul de bază U. Folosind dia. Un burghiu de 3 mm (1/8 ") cu un burghiu de foraj, face Două găuri de distanță egale pe canalul U de bază prin panoul lateral. Acționați un șurub de autoapărare (S4) prin canalul de bază U spre panoul lateral. Repetați acest lucru pentru fiecare panou lateral. Vezi lovitura.
- BG** Прикрепете всеки страничен панел (WPA1↑,WPA2↑) отдолу към основния U-канал. Използвайки диа. 3 мм (1/8 ") тренировка с мощност пробиване, направи две равни отвори дистанция на основния U-канал през страничния панел. Задвижете винт за самобърсначка (S4) през базовия U-канал към страничния панел. Повторете това за всеки страничен панел. Вижете издуването.
- TR** Alttaki her bir yan paneli (WPA1↑,WPA2↑) Taban U kanalına takın. Bir dia kullanma 3 mm (1/8 ") matkapla delin, Yan Panelden Taban U kanalında iki eşit mesafe deliği yapın. Taban U-kanalından yan panele kendinden kilavuzlu bir vidayı (S4) sürün. Her bir Yan Panel için bunu tekrarlayın. Patlama bakın.



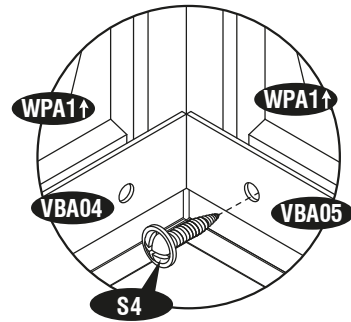
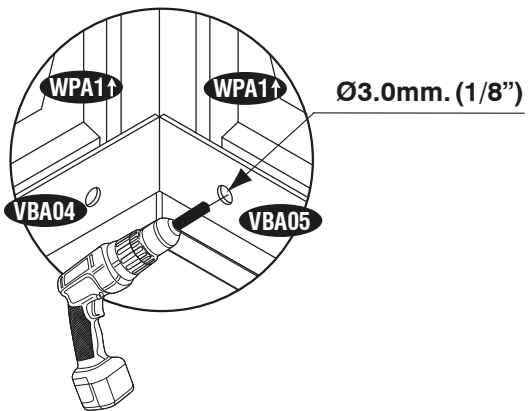
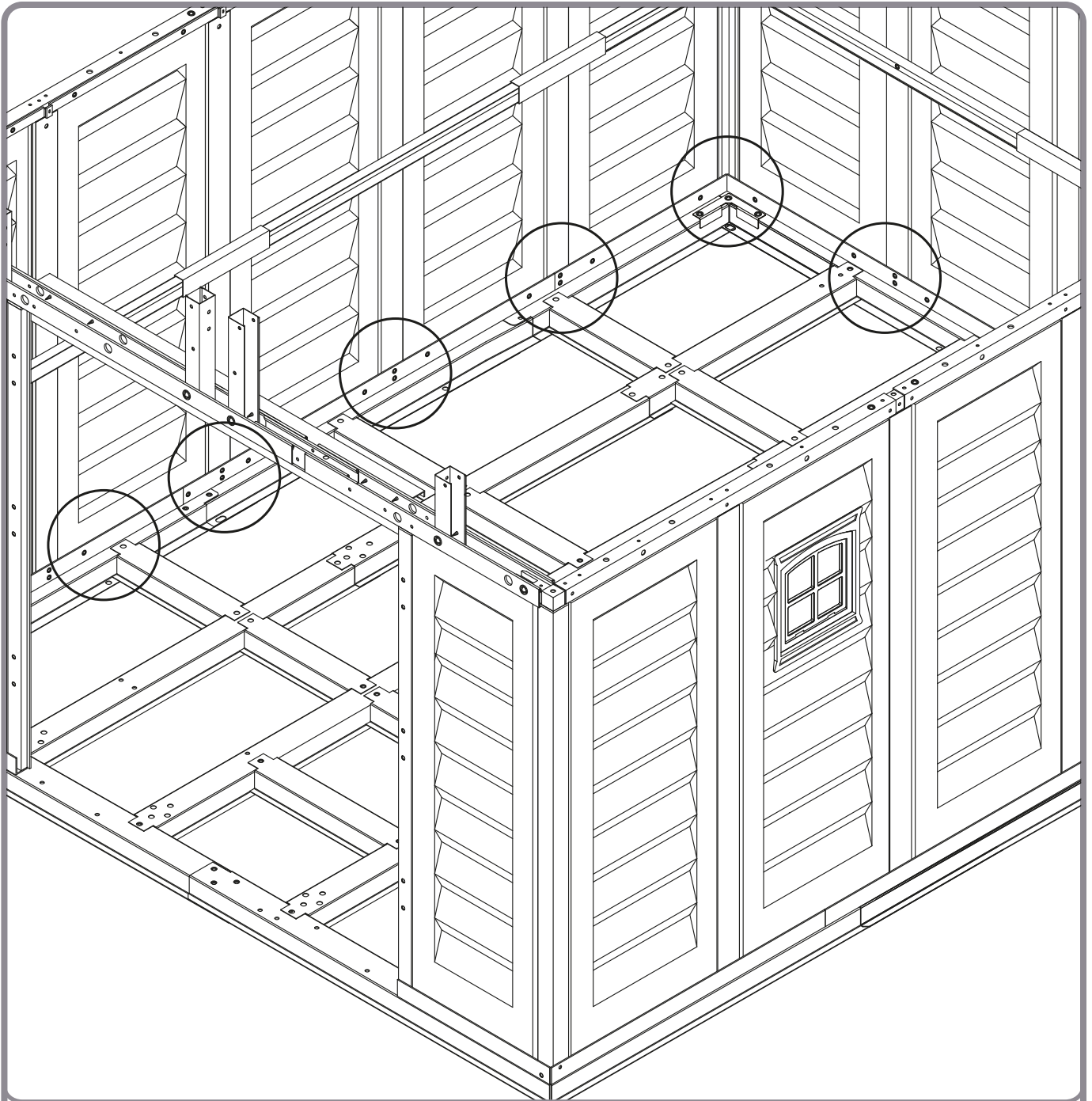



- EN** Attach each Side Panel (WPA1↑,WPA2↑) on top to the Roof Structure (VRA01,VRA02,VRA06 & VRA07). Using a dia. 3mm (1/8") drill with a power drill, make two equal distance holes on the Side Panel through the Roof Structure. Drive a self tapping screw (S4) through the Side Panel to the Roof Structure. Repeat this for every Side Panel. See blowup.
- FR** Fixez chaque panneau latéral (WPA1↑,WPA2↑) au-dessus de la structure de toit (VRA01,VRA02,VRA06 & VRA07). Avec un foret de 3 mm (1/8") et une perceuse électrique, percez deux trous à égale distance sur le panneau latéral dans la structure de toit. Insérez une vis autotaraudeuse (S4) à travers le panneau latéral dans la structure de toit. Répétez cette opération avec chaque panneau latéral. Voir l'agrandissement.
- DE** Befestigen Sie jede Seitenwand (WPA1↑, WPA2↑) oben an der Dachkonstruktion (VRA01,VRA02,VRA06 & VRA07). Verwenden eines Durchmessers Bohren Sie 3 mm (1/8 Zoll) mit einer Bohrmaschine und bohren Sie zwei Löcher mit gleichem Abstand in die Seitenwand durch die Dachkonstruktion. Fahren Sie eine selbstschneidende Schraube (S4) durch die Seitenverkleidung zur Dachkonstruktion. Wiederholen Sie diesen Vorgang für jede Seitenwand. Siehe Explosion.
- ES** Fije cada panel lateral (WPA1↑,WPA2↑) en la parte superior de la estructura del tejado (VRA01,VRA02,VRA06 & VRA07). Usando un día. 3 mm (1/8 ") perfora con un taladro eléctrico, hacer dos agujeros a la misma distancia en el panel lateral a través de la estructura del techo. Introduzca un tornillo auto-roscante (S4) a través del panel lateral a la estructura del techo. Repita esto para cada panel lateral. Ver ampliación.
- PT** Posicione cada painel lateral (WPA1↑,WPA2↑) na parte superior da estrutura de telhado (VRA01,VRA02,VRA06 & VRA07). Usando uma furadeira 3mm (1/8") de alto desempenho, fazer dois furos igual distância do painel lateral por meio da estrutura do telhado. Dirigir um parafuso auto escutas (S4) através do painel lateral para a estrutura do telhado. Repita o processo para cada painel lateral. Veja ampliar.
- NL** Bevestig de zijpanelen (WPA1↑,WPA2↑) geplaatst aan de dakconstructie (VRA01,VRA02,VRA06 & VRA07). Met een diameter 3mm(1/8") boor, maak met een boormachine twee soortgelijke gaatjes op de Basis "U" kanaal via het zijpaneel. Zet een zelftappende schroef (S4) door de Basis "U" kanaal om het zijpaneel te bevestigen. Herhaal dit voor elke zijpaneel. Zie blowup.
- CS** Připojte každý boční panel (WPA1↑,WPA2↑) na vrcholu na střešní konstrukci (VRA01,VRA02,VRA06 & VRA07). Použitím prům. 3mm (1/8") vrtáku s vrtáčkou, udělat dvě stejné vzdálenosti děr na bočním panelu přes střešní konstrukci. Zavřete samořezný šroub (S4) přes postranním panelu na střešní konstrukci. Tento postup opakujte pro každý boční panel. Viz blowup.
- SK** Pripojte každý bočný panel (WPA1↑, WPA2↑) hore na konštrukciu strechy (VRA01,VRA02,VRA06 & VRA07). Pomocou dia. Vrtáčka 3 mm (1/8 ") s výkonným vrtákom vytvára dva bočné otvory na bočnom paneli cez strešnú konštrukciu. Pohnite samořeznú skrutku (S4) cez bočný panel k strešnej konštrukcii. Zopakujte to pre každý bočný panel. Pozri fúkanie.
- SL** Pritrdite posamezni Stranski Panel (WPA1↑,WPA2↑) na vrhu na strešno konstrukcijo (VRA01,VRA02,VRA06 & VRA07). Z uporabo 3mm (1/8") vrtanja z vrtalnim strojem, narediti dve luknji enake razdalje na stranski plošči skozi strešno konstrukcijo. Pričvrstite samovrezni vijak (S4) skozi stranski plošči na strešno konstrukcijo. To ponovite za vsako stranico. Oglejte si povečavo.
- HR** Pričvrstite svaku bočnu ploču (WPA1↑, WPA2↑) na vrh na krovnu strukturu (VRA01,VRA02,VRA06 & VRA07). Korištenje dijaprojektije. Izbušite 3 mm (1/8 inča) bušilicom za snagu i napravite dvije rupe za jednake udaljenosti na bočnoj ploči kroz krovnu strukturu. Vozite vijak za samolijepljanje (S4) kroz bočnu ploču na krovnu strukturu. Ponovite ovo za svaku bočnu ploču. Pogledajte blowup.
- HU** Csatlakoztassa a tetőszerkezethez tartozó minden oldallapot (WPA1↑, WPA2↑) tetejére (VRA01,VRA02,VRA06 & VRA07). Dia. 3 mm-es (1/8 ") fúrógépet fúróval, készítsen két egyenlő távolságot az oldallapon a tetőszerkezeten keresztül. Hajtsa be az önmetsző csavart (S4) az oldalsó panelel keresztül a tetőszerkezethez. Ezt ismétlje meg minden oldallaphoz. Lásd a fűjást.
- SV** Fäst varje sidopanel (WPA1↑, WPA2↑) ovanpå takkonstruktionen (VRA01,VRA02,VRA06 & VRA07). Använda en bild 3 mm (1/8 ") borr med en kraftborr, gör två lika distanshål på sidopanelen genom takstrukturen. Kör en självtuttagsskruv (S4) genom sidopanelen till takstrukturen. Upprepa detta för varje sidopanel. Se uppblåsning.
- IT** Attaccare ciascun pannello laterale (WPA1↑, WPA2↑) in cima alla struttura del tetto (VRA01,VRA02,VRA06 & VRA07). Utilizzando un dia. Trapano da 3mm (1/8 ") con trapano elettrico, creare due fori uguali per la distanza sul pannello laterale attraverso la struttura del tetto. Guidare una vite autofilettante (S4) attraverso il pannello laterale fino alla struttura del tetto. Ripeti questo per ogni pannello laterale. Vedi l'ingrandimento.
- PL** Przymocuj każdy panel boczny (WPA1↑, WPA2↑) u góry do konstrukcji dachu (VRA01,VRA02,VRA06 & VRA07). Korzystanie z dia. Wiertło 3 mm (1/8 ") za pomocą wiertarki, wykonaj dwa otwory o równej odległości na panelu bocznym przez konstrukcję dachu. Przeprowadź śrubę samogwintującą (S4) przez panel boczny do konstrukcji dachu. Powtórz to dla każdego panelu bocznego. Zobacz wysadzenie.
- RO** Przymocuj każdy panel boczny (WPA1↑, WPA2↑) na górze do konstrukcji dachu (VRA01,VRA02,VRA06 & VRA07). Korzystanie z średnicy Wiertło 3 mm (1/8 ") z wiertarką, wykonaj dwa równe otwory w panelu bocznym przez konstrukcję dachu. Przeciągnij wkręt samogwintujący (S4) przez panel boczny do konstrukcji dachu. Powtórz to dla każdego panelu bocznego. Zobacz wybuch.
- BG** Прикрепете всеки страничен панел (WPA1↑, WPA2↑) нагоре към конструкцията на покрива (VRA01,VRA02,VRA06 & VRA07). Използвайте диа. 3 мм (1/8 ") тренировка с мощност пробиване, направи две равни отвори дистанция на страничния панел през покривната конструкция. Задвижете винт (S4) чрез страничния панел към конструкцията на покрива. Повторете това за всеки страничен панел. Вижте издуването.
- TR** Her bir Yan Paneli (WPA1↑, WPA2↑) üstünü Çatı Yapısına (VRA01,VRA02,VRA06 & VRA07) takın. Bir dia kullanma 3 mm (1/8 ") matkapla delin, Yan Panelde Çatı Yapısı ile iki eşit mesafe deliği yapın. Yan Panelden Çatı Yapısına bir kendinden kılavuzlu vida (S4) sürün. Her bir Yan Panel için bunu tekrarlayın. Patlama bakın.







EN Important Warranty Information

FR Informations Importantes Concernant La Garantie

DE Wichtige Informationen zur Gewährleistung

ES Información importante sobre la garantía

PT Importantes Informações de Garantia

NL Belangrijke Informatie over de garantie

CS Důležitá informace o záruce

SK Dôležitá informácie o záruke

SL Pomembne Garancijske Informacije

HR Važne informacije o jamstvu

HU Fontos jótállási információk

SV Viktig garantiinformation

IT Informazioni importanti sulla garanzia

PL Ważne informacje gwarancyjne

RO Informații importante privind garanția

BG Важна информация за гаранцията

TR Önemli Garanti Bilgileri



EN The 'DURAMAX' shed has been tested and passed high wind loads in a controlled laboratory environment when installed with the high wind installation guidelines. Natural high wind areas create wind at unpredictable speeds that are very difficult to capture accurately by location. As such we cannot guarantee the performance of the shed in these extreme situations

FR Le hangar ' DURAMAX ' a été testé et passé des charges de vent élevées dans un environnement de laboratoire contrôlé lorsqu'il est installé avec les directives d'installation de haute vent . Naturelles, les zones de vents forts créent vent à des vitesses imprévisibles qui sont très difficiles à saisir avec précision par emplacement . En tant que tel , nous ne pouvons pas garantir la performance de la foule dans ces situations.

DE Das "DURAMAX" -Haus wurde getestet und hat hohe Windlasten in einer kontrollierten Laborumgebung bestanden, wenn es mit den Richtlinien für hohe Windinstallationen installiert wurde. Natürliche Starkwindgebiete erzeugen Wind mit unvorhersehbaren Geschwindigkeiten, die aufgrund des Standorts nur schwer erfasst werden können. Daher können wir die Leistung des Schuppens in diesen extremen Situationen nicht garantieren.

ES El cobertizo ' DURAMAX ' ha sido probado y aprobado cargas de viento en un entorno controlado de laboratorio cuando se instala con las pautas de instalación de vientos fuertes . Espacios naturales de vientos crean viento a velocidades impredecibles que son muy difíciles de capturar con precisión la ubicación. Como tal , no podemos garantizar el funcionamiento de la nave en.

PT O galpão 'DURAMAX' foi testado e passou por altas cargas de vento em um ambiente de laboratório controlado quando instalado com as diretrizes de instalação de alta energia eólica. As áreas naturais de ventos fortes criam vento a velocidades imprevisíveis que são muito difíceis de capturar com precisão por localização. Como tal, não podemos garantir o desempenho do galpão nessas situações extremas

NL Het 'DURAMAX'-schuurtje is getest en heeft hoge windbelastingen doorstaan in een gecontroleerde laboratoriumomgeving, indien geïnstalleerd met de richtlijnen voor hoge winden. Natuurlijke windrijke gebieden creëren wind met onvoorspelbare snelheden die zeer moeilijk nauwkeurig op locatie kunnen worden vastgelegd. Als zodanig kunnen we de prestaties van de schuur in deze extreme situaties niet garanderen

CS Ústředna DURAMAX byla testována a prošla vysokým zatížením větrem v kontrolovaném laboratorním prostředí, když byla instalována s pokyny pro větrnou instalaci. Přírodní větrné plochy vytvářejí vítr při nepředvídatelných rychlostech, které je velmi obtížné přesně zachytit podle místa. Jako takové nemůžeme zaručit výkon haly v těchto extrémních situacích

SK Dúchadlá "DURAMAX" boli testované a prešli vysokou záťažou vetra v kontrolovanom laboratórnom prostredí, keď sú inštalované so smernicami pre vysoký vietor. Prírodné oblasti s vysokým vetrom vytvárajú vietor pri nepredvídateľných rýchlostiach, ktoré sa veľmi ťažko zachytia presne podľa miesta. Ako taký nemôžeme zaručiť výkonnosť kóline v týchto extrémnych situáciách

SL Preskus "DURAMAX" je bil preizkušen in prešel velike obremenitve vetra v nadzorovanem laboratorijskem okolju, če je bil nameščen s smernicami za visoko vetrove. Naravni viri vetra ustvarijo veter ob nepredvidljivih hitrostih, ki jih je zelo težko natančno zajemati glede na lokacijo. Kot taka ne moremo zagotoviti učinkovitosti skladišča v teh skrajnih razmerah

HR Prostor "DURAMAX" je testiran i prošao velike opterećenja vjetrom u kontroliranom laboratorijskom okruženju kada je instaliran s visokim smjernicama za instalaciju vjetra. Prirodni visoki vjetrojevi stvaraju vjetar na nepredvidljivim brzinama koje su vrlo teško točno snimiti po lokaciji. Kao takav ne možemo jamčiti izvedbu prolivenih u ovim ekstremnim situacijama

HU A DURAMAX fészerét ellenőrzött laboratórium környezetben tesztelték, és nagy szélterhelést vezettek be, amikor a nagy szélsőkapási irányelvekkel telepítették. A természeti nagy szélterületek olyan kiszámíthatatlan sebességű szélsősebességet hoznak létre, amelyet nagyon nehéz rögzíteni helyesen a helyszínen. Így nem garantálhatjuk a fészer teljesítményét ebben a szélsőséges helyzetben

SV DURAMAX-skjulet har testats och passerat höga vindbelastningar i en kontrollerad laboratoriemiljö när den installerats med riktlinjerna för hög vindkraft. Naturliga höga vindområden skapar vind med oförutsägbara hastigheter som är mycket svåra att fånga noggrant på plats. Som sådan kan vi inte garantera skurets prestanda i dessa extrema situationer

IT Il capannone 'DURAMAX' è stato testato e ha superato carichi di vento elevato in un ambiente di laboratorio controllato quando installato con le linee guida per l'installazione del vento forte. Le aree naturali del vento forte creano vento a velocità imprevedibili che sono molto difficili da catturare con precisione in base alla posizione. Pertanto non possiamo garantire le prestazioni del capannone in queste situazioni estreme





- PL** Szopa "DURAMAX" została przetestowana i przeszła duże obciążenia wiatrem w kontrolowanym środowisku laboratoryjnym, gdy zainstalowano ją zgodnie z wytycznymi dotyczącymi instalacji wiatrowej. Naturalne obszary o dużym natężeniu wiatru wytwarzają wiatr o nieprzewidywalnych prędkościach, które są bardzo trudne do uchwycenia dokładnie według lokalizacji. W związku z tym nie możemy zagwarantować wykonania szopy w tych ekstremalnych sytuacjach.
- RO** Dulapul "DURAMAX" a fost testat și a fost încărcat cu încărcături puternice de vânt într-un mediu de laborator controlat atunci când este instalat cu instrucțiunile de instalare a vântului. Zonele naturale cu vânt puternic creează vânt la viteze imprevizibile, care sunt foarte greu de capturat cu precizie în funcție de locație. Ca atare, nu putem garanta performanța magazinului în aceste situații extreme
- BG** Тръбопроводът "DURAMAX" е тестван и преминава в силно натоварване от вятър в контролирана лабораторна среда, когато е инсталиран с насоките за вятърна инсталация. Природните високи ветрови зони създават вятър при непредсказуеми скорости, които са много трудни за улавяне по точно местоположение. Като такива не можем да гарантираме изпълнението на навеса в тези крайни ситуации
- TR** "DURAMAX" dökümü, yüksek rüzgar tesisatı kurallarına göre kurulduğunda kontrollü bir laboratuvar ortamında yüksek rüzgar yüklerini test etti ve geçti. Doğal yüksek rüzgârlı bölgeler, konuma göre hassas bir şekilde yakalanması çok zor olan, öngörülemeyen hızlarda rüzgar yaratır. Bu nedenle, bu olağanüstü durumlarda kulübenin performansını garanti edemeyiz.



- EN** "For dismantling the Shed, Customer has to follow instructions manual in reverse direction."
- FR** " Pour le démantèlement du hangar, client doit suivre le manuel d'instructions dans le sens inverse."
- DE** In Gebieten mit starken Schneefällen oder starkem Wind empfehlen wir das nachstehende Zubehör.
- ES** "Para el desmantelamiento de la nave, cliente tiene que seguir instrucciones en sentido contrario".
- PT** "Para desmontar o galpão, cliente tem de seguir o manual de instruções em sentido reverso".
- NL** "Voor de ontmanteling van de schuur, klant heeft te volgen instructiehandleiding in omgekeerde richting."
- CS** 'Pro demontáž přístřešku musí zákazník postupovat podle pokynů v opačném směru.'
- SK** 'Pri demontáži prístrešku musí zákazník postupovať podľa pokynov v opačnom smere.'
- SL** 'Za demontažo skladišča mora naročnik slediti priročniku v obratni smeri.'
- HR** 'Za demontažu zida, korisnik mora slijediti priručnike za upute u obrnutom smjeru'.
- HU** 'A fészter lebontásához az Ügyfélnek vissza kell követnie az utasításokat.'
- SV** 'För att demontera Shed måste kunden följa instruktionsboken i omvänd riktning.'
- IT** 'Per lo smontaggio del capannone, il cliente deve seguire manualmente le istruzioni in senso inverso'..
- PL** do demontażu szopy, należy postępować zgodnie z instrukcją obsługi w odwrotnym kierunku
- RO** 'Pentru dezmembrarea Shedului, Clientul trebuie să urmeze manualul de instrucțiuni în sens invers.'
- BG** 'За демонтиране на навеса клиентът трябва да следва инструкциите в наръчник в обратна посока.'
- TR** 'Shed'in sökülmesi için, Müşteri yönergeleri ters yönde takip etmelidir.'



**EN** ADDITIONAL ACCESSORIES AVAILABLE  
(Not included)

**FR** ACCESSOIRES ADDITIONNELS DISPONIBLES  
(non inclus)

**DE** WEITERES ZUBEHÖR  
(Nicht enthalten)

**ES** ACCESORIOS ADICIONALES DISPONIBLES  
(no incluida)

**PT** ACESSÓRIOS ADICIONAIS DISPONÍVEIS  
(não incluído)

**NL** EXTRA ACCESSOIRES AANWEZIG.  
(niet inbegrepen)

**CS** MOŽNÉ DALŠÍ DOPLŇKY.  
(není součástí balení)

**SK** DOSTUPNÉ DODATOČNÉ PRÍSLUŠENSTVO  
(nie je súčasťou balenia)

**SL** RAZPOLOŽLJIVA DODATNA OPREMA  
(niso vključene)

**HR** DODATNI PROGRAMI RASPOLOŽIV  
(nije uključeno)

**HU** TOVÁBBI MEGVÁSÁROLHATÓ TARTOZÉKOK  
(nem tartozék)

**SV** YTTERLIGARE TILLGÄNGLIGA ACCESSOARERV  
(ingår ej)

**IT** ACCESSORI SUPPLEMENTARI DISPONIBILI  
(non incluso)

**PL** DOSTĘPNE DODATKOWE AKCESORIA  
(nie wliczone)

**RO** ACCESORIILE SUPLIMENTARE DISPONIBILE  
(Nu este inclus)

**BG** ДОПЪЛНИТЕЛНИ НАЛИЧНИ АКЕСОАРИ  
(не е включен)

**TR** EK AKSESUARLAR MEVCUTTUR  
(dahil değildir)



**EN** These accessories are required in case of heavy snow or high wind areas.  
Please choose relevant accessories according to your needs.

**FR** Ces accessoires sont exigés en cas de zones de la neige forte ou du vent fort.  
Veuillez choisir les accessoires appropriés selon vos besoins.

**DE** In Gebieten mit starken Schneefällen oder starkem Wind empfehlen wir das nachstehende Zubehör.

**ES** Estos accesorios son requeridas en caso de fuertes nevadas o zonas de alto viento.  
Por favor, elija los accesorios pertinentes de acuerdo a sus necesidades.

**PT** Estes acessórios são necessários em áreas de vento forte e/ou neve.  
Por favor, escolha os acessórios pertinentes de acordo com suas necessidades.

**NL** Deze accessoires zijn nodig in geval van hevige sneeuw val of gebieden waar het hard waait.  
Gebruik de accessoires die u nodig heeft.

**CS** Tyto doplňky se vyžadují v místech s velkým množstvím sněhu či silným větrem.  
Zvolte si prosím příslušné doplňky podle vašich potřeb.

**SK** Toto príslušenstvo sa vyžaduje v prípadoch ťažkého a veľkého množstva snehu alebo silného vetra.  
Vyberte si relevantné príslušenstvo na základe vašich potrieb.

**SL** Ta dodatna oprema se uporablja v primeru velike količine zapadlega snega ali če lopa stoji na zelo vetrovnem območju.  
Izberite ustrezno opremo glede na to, kaj dejansko potrebujete.

**HR** Ovi dodaci su potrebni u slučaju teškog snijega ili jak vjetar regija.  
Molimo odaberite relevantne dodatne opreme prema vašim potrebama.

**HU** Ezekre a tartozékokra sürű havazás esetén vagy erősen szeles területeken van szükség.  
Kérjük, igénye szerint válasszon a megfelelő tartozékok közül.

**SV** Dessa accessoarer behövs vid tung snö eller i områden med hård vind.  
Var god välj relevanta accessoarer efter behov.

**IT** Questi accessori sono importanti in caso di neve o aree soggette a forti venti.  
Per favore, scegli questi accessori in base ai tuoi bisogni.

**PL** Akcesoria te są wymagane w przypadku terenów, na których zdarzają się duże opady śniegu lub silne wiatry.  
Wybierz odpowiednie akcesoria w zależności od potrzeb.

**RO** Aceste accesorii sunt necesare în cazul în care apar depuneri masive de zăpadă sau în zonele în care bate vânt puternic.  
Vă rugăm alegeți accesorii potrivite nevoilor dumneavoastră.

**BG** Тези аксесоари се изискват в случай на тежък сняг или при райони със силен вятър.  
Моля подберете съответните аксесоари според нуждите.

**TR** Bu aksesuarlar yoğun kar yağışı ya da kuvvetli rüzgar alan bölgelerde gereklidir.  
Lütfen ihtiyaçlarınıza uygun gerekli aksesuarları seçiniz.

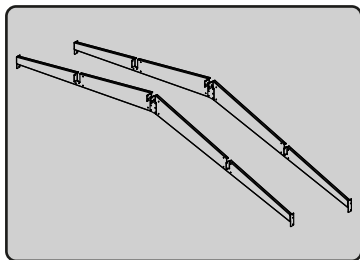

1

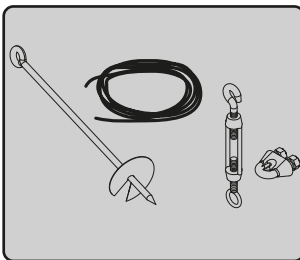

2

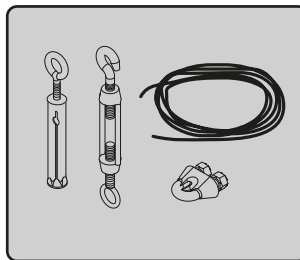

3

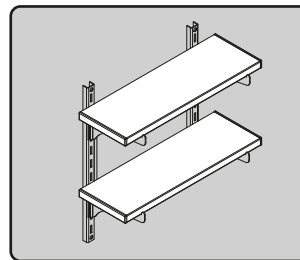

4

1

EN SUPER SUPPORT KIT  
 FR SUPER SUPPORT KIT  
 DE SUPER SUPPORT KIT  
 ES KIT DE SÚPER SOPORTE  
 PT SUPER KIT DE SUPORTE  
 NL SUPER STEUNKIT  
 CS SUPER SUPPORT KIT  
 SK SUPER PODPORNÁ SADA  
 SL SUPER SUPPORT KIT

HR SUPER SUPPORT KIT  
 HU SUPER SUPPORT KIT  
 SV SUPER SUPPORT KIT  
 IT KIT SUPER SUPPORTO  
 PL ZESTAW SUPER WSPARCIA  
 RO KIT SUPORT SUPER  
 BG СУПЕР ПОДДРЪЖКА  
 TR SÜPER DESTEK KİTİ

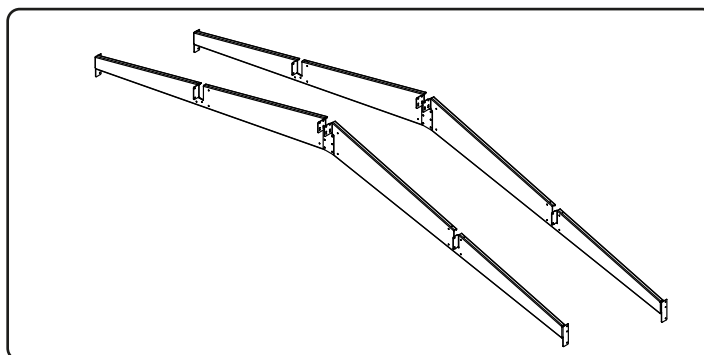

- EN** Extra roof beams for added protection against heavy snow accumulation. **For heavy snow area**
- FR** Poutres de toit supplémentaires pour une protection supplémentaire contre les fortes accumulations de neige. **Pour les zones de neige abondante.**
- DE** Zusätzliche Dachbalken für zusätzlichen Schutz vor starker Schneeanhäufung. **Für starkes Schneegebiet.**
- ES** Vigas de techo adicionales para mayor protección contra la acumulación de nieve pesada. **Para zona de nevadas fuertes**
- PT** Vigas de teto extras para proteção adicional contra acúmulo de neve pesada. **Para área de neve pesada.**
- NL** Extra dakbalken voor extra bescherming tegen zware sneeuwophoping. **Voor zwaar sneeuwgebied.**
- CS** Extra střešní nosníky pro zvýšenou ochranu proti hromadění sněhu. **Pro těžkou sněhovou oblast.**
- SK** Extra strešné nosníky pre vyššiu ochranu pred hromadením snehu. **Pre ťažké snehové oblasti.**
- SL** Dodatni strešni nosilci za dodatno zaščito pred nabiranjem snega. **Za območje močnega snega.**
- HR** Dodatne grede za krov za dodatnu zaštitu od nakupljanja snijega. **Za područje s jakim snijegom.**
- HU** Extra tetőgerendák a nagyobb hó felhalmozódás elleni további védelem érdekében. **Nehéz hóviszonyokhoz.**
- SV** Extra takbjälkar för extra skydd mot tung snöansamling. **För tung snöområde.**
- IT** Travi del tetto extra per una maggiore protezione contro l'accumulo di neve pesante. **Per area con forti nevicate.**
- PL** Dodatkowe belki dachowe dla dodatkowej ochrony przed silnym gromadzeniem się śniegu. **Do intensywnego śniegu.**
- RO** Grinzi de acoperiș suplimentare pentru o protecție suplimentară împotriva acumulării abundente de zăpadă **Pentru zona de zăpadă grea.**
- BG** Допълнителни греди на покрива за допълнителна защита срещу натрупване на обилен сняг. **За зона с обилен сняг.**
- TR** Ağır kar birikimine karşı ek koruma için ekstra tavan kirişleri. **Yoğun kar alanı için.**



2

- |                                    |                                |
|------------------------------------|--------------------------------|
| EN ANCHOR KIT (Soil)               | HR SIDRO KOMPLET (tla)         |
| FR KIT D'ANCRE (Sol)               | HU RÖGZÍTŐ FELSZERELÉS (Talaj) |
| DE ANKER-KIT (Boden)               | SV FÖRANKRINGS-KIT (Jord)      |
| ES KIT DE ANCLAJE (Suelo)          | IT KIT DI ANCORAGGIO (Suolo)   |
| PT KIT DE APOIO (Solo)             | PL ZESTAW DO MOCOWANIA (Grunt) |
| NL ANKER GEREEDSCHAP (bodem)       | RO SET DE ANCORARE (ÎN SOL)    |
| CS KOTEVNÍ SOUPRAVA (Hlína)        | BG КОМПЛЕКТ АНКЕРИ (Почва)     |
| SK UKOTVOVACIE PRÍSLUŠENSTVO (zem) | TR EKLEMLEME KİTİ (Toprak)     |
| SL SIDRNA OPREMA (zemlja)          |                                |

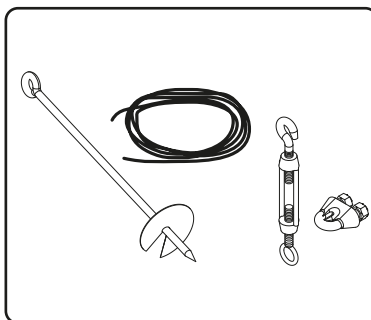

-  EN Wire rope with twist augers for sheds installed with foundation (Wood / Metal) on soil.  
**For heavy wind area.**
- FR Fil de fer avec des foreuses de torsion pour des hangars installés avec la base (en métal / en bois) sur le sol. **Pour la zone du vent fort.**
- DE Seil mit Erdbohrer bei einem Unterbau (Holz / Metall) auf dem Boden.  
**Für Gebiete mit starkem Wind.**
- ES El cable metálico para casetas instaladas con kit de estructura de suelo fijada al terreno.
- PT Cabo metálico com brocas para galpões instalados com base (Madeira/Metal) em solo.  
**Para áreas de vento forte.**
- NL Bedrading met kronkelige grondboren voor het schuurtje moet met fundering worden geïnstalleerd (hout/metaal) op bodem. **Voor hevige wind gebieden.**
- CS Drátěné lano se vrtáky pro kůlny postavené se základy (dřevo / kov) na hlíně.  
**Pro místa se silným větrem.**
- SK Drôtené lano s krútenými špirálovitými šnekmi pre hangáre nainštalované zo základom (drevo/kov) na zemi. **Pre oblasť so silným vetrom.**
- SL Žična vrv z velikim svedrom z enojno spiralo za lope nameščene na temelju (les/kovina) na zemlji.  
**Za zelo vetrovna območja.**
- HR čelikčelo s okretati svrdlom za baca instaliran s temelja (Drvo / Metal) na tlu.  
**Za teške vjetar području.**
- HU Drótkötél spirálfúrókkal alappal rendelkező kerti fészerekhez (Fa / fém) talajon.  
**Erősen szeles területekre.**
- SV Wirelås med tvistborr för skjul installerade med grund (trä / metall) på jord.  
**För områden med hård vind.**
- IT Fune con trivella a spirale per capannoni installati con fondamenta (legno/metallo) sul suolo.  
**Per aree soggette a forte vento.**
- PL Lina stalowa ze świdrami dla magazynków montowanych na pod stawie (Drewno/Metal) do gruntu.  
**Przeznaczone do użytkowania na obszarach występowania silnych wiatrów.**
- RO Cabluri cu burghie răsucite pentru magazinele asamblate pe fundație (Lemn / Metal) în sol.  
**Pentru zonele în care bate vânt puternic.**
- BG Стоманено въже с извити сонди за заслони, монтирани върху фундаменти (Дърво / Метал) върху почва.  
**За силно ветровита зона.**
- TR Zemin (tahta/metal) toprak üstüne gelecek şekilde inşa edilen barnaklar için burgulu matkap ve tel ip.  
**Kuvvetli rüzgar alan yerler için.**

3

- |                                      |                                |
|--------------------------------------|--------------------------------|
| EN ANCHOR KIT (Concrete)             | HR SIDRO KOMPLET (beton)       |
| FR KIT D'ANCRE (Béton)               | HU RÖGZÍTŐ FELSZERELÉS (Beton) |
| DE Verankerungsset (Beton)           | SV FÖRANKRINGS-KIT (Betong)    |
| ES KIT DE ANCLAJE (hormigón)         | IT KIT DI ANCORAGGIO (cemento) |
| PT KIT DE APOIO (Concreto)           | PL ZESTAW DO MOCOWANIA (Beton) |
| NL ANKER GEREEDSCHAP (Beton)         | RO SET DE ACORARE (Beton)      |
| CS KOTEVNÍ SOUPRAVA (Beton)          | BG КОМПЛЕКТ АНКЕРИ (Бетон)     |
| SK UKOTVOVACIE PRÍSLUŠENSTVO (betón) | TR EKLEMLEME KİTİ (Beton)      |
| SL SIDRNA OPREMA (beton)             |                                |

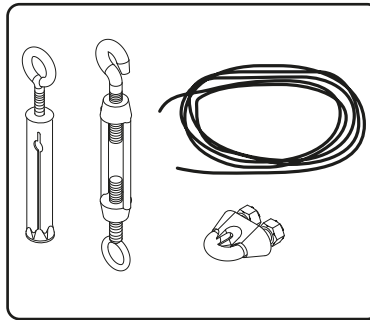

- EN** Eye bolt with wire rope for sheds installed with foundation (Wood / Metal) on concrete.  
**For heavy wind area.**
- FR** OEil à queue filetée avec fil en fer pour des hangars installés avec la base (en métal / en bois) sur le béton.  
**Pour la zone du vent fort.**
- DE** Ringschraube mit Seil für Gerätehäuser mit einem Unterbau (Holz / Metal) auf Beton.  
**Für Gebiete mit starkem Wind.**
- ES** Coloque pernos de ojo y el cable metálico para las zonas de fuerte viento.  
**Para el área del fuerte viento.**
- PT** Cavilha com cabo de aço para galpões instalados com base ( Madeira/Metal) em concreto.  
**Para áreas de vento forte.**
- NL** Eyebolt met stalendraad voor schuurtje moet worden geïnstalleerd met fundering ( hout/metaal) op beton.  
**Voor hevige wind gebieden.**
- CS** Oka s drátěným lanem pro kůlny postavené se základy (dřevo / kov) na betonu.  
**Pro místa se silným větrem.**
- SK** Šrob s okom s drôtovým lanom pre hangáre nainštalované so základom (drevo/kov) na betóne.  
**Pre oblasť so silným vetrom.**
- SL** Očesni vijak z žično vrvjo za lope nameščene na temelju (les/kovina) na betonu.  
**Za zelo vetrovna območja.**
- HR** oči vijak žičane užadi za baca Installer sa temelja (Drvo / Metal) na betonu.  
**Za teške vjetar području.**
- HU** Gyűrűs csavar drótkötéllal alappal rendelkező kerti fészerekhez (Fa / fém) betonon.  
**Erősen szeles területekre.**
- SV** Stagögla med wirelås för skjul som installerats med grund (Trä / Metall) på betong.  
**För områden med hård vind.**
- IT** Vite ad occhiello con fune per capannoni installati con fondamenta (legno/metallo) sul cemento.  
**Per aree soggette a forte vento.**
- PL** Śruba z uchem z liną stalową dla magazynków montowanych na podstawie (Drewno/Metal) do betonu.  
**Przeznaczony do użytkowania na obszarach występowania silnych wiatrów.**
- RO** Șurub cu ochi atașat la un cablu pentru magazinele asamblate pe fundație (Lemn / Metal) în beton.  
**Pentru zonele în care bate vânt puternic.**
- BG** Шарнирен болт със стоманено въже за заслони, инсталирани с фундамент (Дърво / Метал) върху бетон.  
**За силно ветровита зона.**
- TR** Zemin (tahta/metal) beton üstüne gelecek şekilde inşa edilen barınaklar için halkalı vida ve tel ip.  
**Kuvvetli rüzgar alan yerler için.**

4

EN SHELF KIT

FR UN KIT D'ÉTAGÈRE

DE REGAL AUSSTATTUNG

ES KIT ESTANTE

PT KIT DE PRATELEIRAS

NL PLANK MONTAGE KIT

CS MONTÁŽNÍ SOUPRAVA POLIC

SK DOPLNKOVÝ KIT

SL KOMPLET POLIC

HR KUPANJE KIT

HU MINISÉGÉT KIT

SV HYLLA KIT

IT KIT MENSOLA

PL PÓŁKA KIT

RO SHELF KIT

BG КОМПЛЕКТ КОЛЕКЦИЯ

TR RAF KİTİ

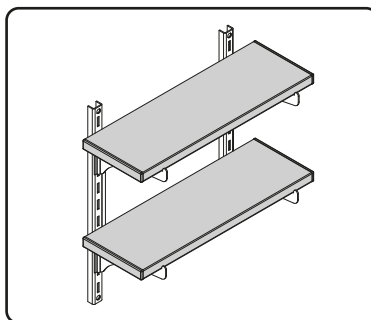

**EN** Easy mounting system on the middle column. 6 inch wide reinforced PVC shelf with end caps.

**FR** Facile système de montage sur la colonne du milieu. Étagère de 6 pouces de large en PVC renforcé avec des embouts.

**DE** Leichte Montage des Systems auf der mittleren Spalte. 6 Zoll breit verstärktes PVC Regal mit Endkappen.

**ES** Fácilsistema de montaje en la columnacentral. Estante de PVC reforzado con tapas de 6 pulgadas de ancho.

**PT** Sistema fácil de montagem a partir da coluna média. Prateleiras de largura de 6 polegadas com tampa.

**NL** Eenvoudige montage systeem op de middelste kolom. 6 inch breed versterkt PVC plank met eindkappen.

**CS** Snadný montážní systém na prostředním sloupci. 6 palců široké vyztužené PVC police s koncovkami.

**SK** Jednoduchá montáž na strednom stĺpci. 6 palcová široká vyzužená polička z PVC s koncovými uzávermi.

**SL** Enostavna pritrditve na srednji steber. 6 palčne široko ojačane PVC police s končnimi pokrovi.

**HR** Jednostavan montažni sustav na srednjem stupu. 6 inča široka armirana PVC polica s završnim kapama.

**HU** Egyszerű szerelőrendszer a középső oszlopra. 6 hüvelykes széles, megerősített PVC polc, zárósapkával.

**SV** Lätt monteringsystem på mellanskolonnen. 6 tum bred förstärkt PVC-hylla med ändkapslar..

**IT** Facile sistema di montaggio sulla colonna centrale. Ripiano in PVC rinforzato largo 6 pollici con tappi terminali.

**PL** Łatwy system montażu na środkowej kolumnie. Szeroka, 6-calowa, wzmocniona półka z PCV z zaślepkami.

**RO** Sistem de montare facil pe coloana din mijloc. Portofoliu din PVC armat de 6 inch, cu capace de capăt.

**BG** Лесна система за монтиране на средната колона. Широко подсилена PVC рафт от 6 инча с капачки.

**TR** Orta kolondaki kolay montaj sistemi. Uç kapakları ile 6 inç genişliğinde güçlendirilmiş PVC raf.

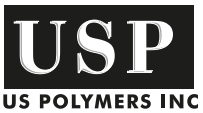

U.S. Polymers, Inc.  
1057 S. Vail Ave  
Montebello, CA 90640,  
United States of America

[www.duramaxbp.com](http://www.duramaxbp.com)