

Elevation View

416L Deck Box

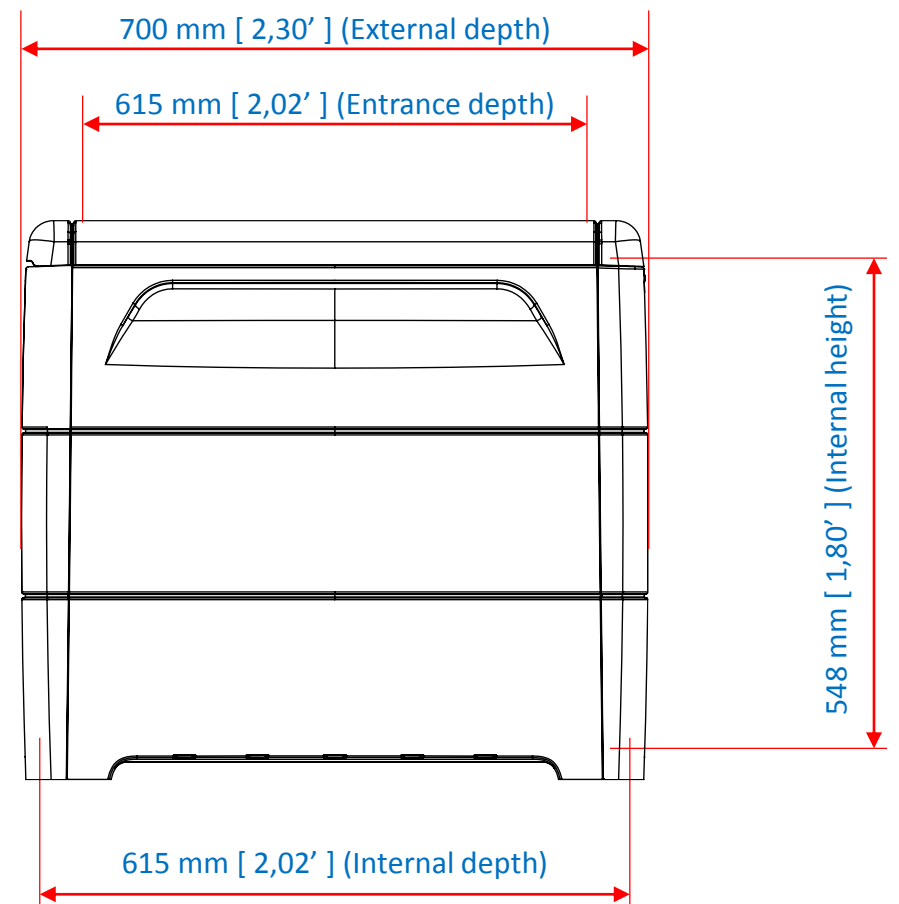

Side View

Note: Dimension tolerance +/- 5 mm.